



**CATALOGUE**  
**SURGICAL INSTRUMENTS**



# Table of Contents



S.No	Descriptions of Items	
01	Skalpellklingen, Skalpellgriffe, Messer Scalpel Blades, Scalpel Handles, Knives Hojas de bisturíes, Mangos de bisturíes, Cuchillos Lame per bisturi, Manici per bisturi, Coltelli	<a href="#">Click Here</a>
02	Scheren , Scissors, Tijeras ,Forbici	<a href="#">Click Here</a>
03	Pinzetten, Forceps, Pinzas, Pinze	<a href="#">Click Here</a>
04	Tuch-, Schlauchklemmen, Tupferzangen Towel Clamps, Sponge and Dressing Forceps, Tubing Clamps Pinzas de campo, Pinzas para vendajes y torundas y para tubos Pinze per fissare le compresse, per medicatura e tamponi, e per tubi	<a href="#">Click Here</a>
05	Klemmen, Forceps, Pinas, Pinze	<a href="#">Click Here</a>
06	Nahtinstrumente, Suture Instruments, Instrumentos para sutura Strumenti per sutura	<a href="#">Click Here</a>
07	Wundhaken, Retractors, Separadores , Divaricatori	<a href="#">Click Here</a>
08	Wundspreizer, Self-Retaining Retractors, Separadores con retenida automática Divaricatori autostatici	<a href="#">Click Here</a>
09	Sonden, Trokare Probes, Trocars Sondas, Trócares Sonde, Trequarti	<a href="#">Click Here</a>
10	Magen, Darm, Mastdarm, Stomach, Intestines, Rectum Estómago, Intestino, Recto, Stomaco, Intestino, Retto	<a href="#">Click Here</a>
11	Galle, Leber, Niere, Blase, Urologie Gall, Liver, Kidney, Bladder, Urology Bilis, Hígado, Riñon, Vejiga, Urología Bile, Fegato, Rene, Vescica, Urologia	<a href="#">Click Here</a>
12	Gynäkologie, Geburtshilfe, Gynecology, Obstetrics, Ginecología, Obstetricia Ginecologia, Ostetricia	<a href="#">Click Here</a>
13	Vorbereitung, Dermatologie , Preparation, Dermatology Preparación, Dermatología Preparazione, Dermatalogia	<a href="#">Click Here</a>
14	Knochenchirurgie, Bone Surgery, Cirugía ósea, Chirurgia ossea	<a href="#">Click Here</a>
15	Sterilisation, Sterilization, Esterilización, Sterilizzazione	<a href="#">Click Here</a>

**Skalpellinge, Skalpellinge, Messer  
Scalpel Blades, Scalpel Handles, Knives  
Hojas de bisturíes, Mangos de bisturíes, Cuchillos  
Lame per bisturi, Manici per bisturi, Coltelli**



**Sterile Skalpellklingen, Skalpellgriffe**  
**Sterile Scalpel Blades, Scalpel Handles**  
**Hojas de bisturíes estériles, Mangos de bisturíes**  
**Lame per bisturi sterili, Manici per bisturi**



No. 3  
13,0 cm, 5"  
AK-1003-03



No. 3  
13,0 cm, 5"  
AK-1003-04



No. 3L  
21,0 cm, 8 1/4"  
AK-1003-05



No. 7  
16,5 cm, 6 1/2"  
AK-1007-06



No. 7K  
13,0 cm, 5"  
AK-1007-07

Sterile Skalpellklingen, Skalpellgriffe  
Sterile Scalpel Blades, Scalpel Handles  
Hojas de bisturíes estériles, Mangos de bisturíes  
Lame per bisturi sterili, Manici per bisturi

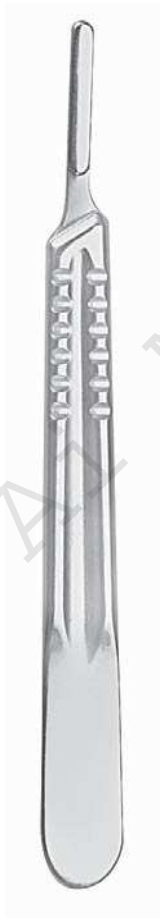

No. 4  
13,5 cm, 5<sup>3</sup>/<sub>8</sub>"  
AK-1004-04



No. 4L  
21,0 cm, 8<sup>3</sup>/<sub>8</sub>"  
AK-1004-04L



No. 8  
13,5 cm, 5<sup>3</sup>/<sub>8</sub>"  
AK-1004-08



No. 9  
14,5 cm, 5<sup>3</sup>/<sub>4</sub>"  
AK-1004-09

Einmal-Skalpelle, steril  
Disposable Scalpels, sterile  
Bisturíes para uso único, estériles  
Bisturi monouso, sterili



Fig. 10  
AK-1005-10



Fig. 11  
AK-1005-11



Fig. 11s  
AK-1005-11S



Fig. 12  
AK-1005-12



Fig. 12d  
AK-1005-12D



Fig. 13  
AK-1005-13



Fig. 15  
AK-1005-15



Fig. 15c  
AK-1005-15C

Einmal-Skalpelle, steril  
Disposable Scalpels, sterile  
Bisturíes para uso único, estériles  
Bisturi monouso, sterili



Fig. 18  
AK-1005-18



Fig. 19  
AK-1005-19



Fig. 20  
AK-1005-20



Fig. 21  
AK-1005-21



Fig. 22  
AK-1005-22



Fig. 23  
AK-1005-23



Fig. 24  
AK-1005-24



Fig. 25  
AK-1005-25

Skalpelle  
Knives  
Bisturies  
Bisturi



Fig. 1 **AK-1006-01**  
Fig. 2 **AK-1006-02**  
Fig. 3 **AK-1006-03**



**OPERATION**  
17,0 cm, 6<sup>3</sup>/<sub>4</sub>"

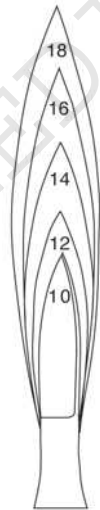

Fig. 10 **AK-1006-10**  
Fig. 12 **AK-1006-12**  
Fig. 14 **AK-1006-14**  
Fig. 16 **AK-1006-16**  
Fig. 18 **AK-1006-18**



**COLLIN**  
16,0 cm, 6<sup>1</sup>/<sub>4</sub>"



Fig. 4 **AK-1006-04**  
Fig. 5 **AK-1006-05**  
Fig. 6 **AK-1006-06**





Fig. 1 **AK-1007-01**  
Fig. 2 **AK-1007-02**  
Fig. 3 **AK-1007-03**  
Fig. 4 **AK-1007-04**  
Fig. 5 **AK-1007-05**



Fig. 1 **AK-1008-01**  
Fig. 2 **AK-1008-02**  
Fig. 3 **AK-1008-03**  
Fig. 4 **AK-1008-04**  
Fig. 5 **AK-1008-05**



Fig. 15 **AK-1008-15**



**DISSECTING**  
17,0 cm, 6¾"



Fig. 6 **AK-1007-06**  
Fig. 7 **AK-1007-07**  
Fig. 8 **AK-1007-08**  
Fig. 9 **AK-1007-09**  
Fig. 10 **AK-1007-10**



**DIEFENBACH**  
16,0 cm, 6¼"

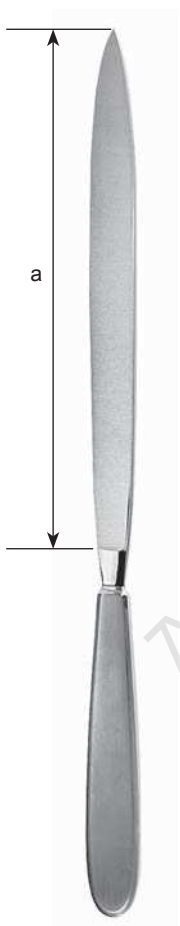

Fig. 6 **AK-1008-06**  
Fig. 7 **AK-1008-07**  
Fig. 8 **AK-1008-08**  
Fig. 9 **AK-1008-09**



Fig. 16 **AK-1008-16**

Amputationsmesser  
 Amputation Knives  
 Cuchillos para amputación  
 Coltelli per amputazione



**COLLIN**

a	
13,0 cm, 5"	<b>AK-1008-13</b>
16,0 cm, 6 <sup>1</sup> / <sub>4</sub> "	<b>AK-1008-16</b>
19,0 cm, 7 <sup>1</sup> / <sub>2</sub> "	<b>AK-1008-19</b>
22,0 cm, 8 <sup>5</sup> / <sub>8</sub> "	<b>AK-1008-22</b>
28,0 cm, 11"	<b>AK-1008-28</b>

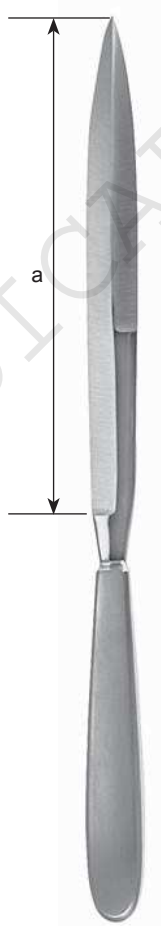

**CATLIN**

A	
16,0 cm, 6 <sup>1</sup> / <sub>4</sub> "	<b>AK-1009-16</b>
19,0 cm, 7 <sup>1</sup> / <sub>2</sub> "	<b>AK-1009-19</b>
22,0 cm, 8 <sup>5</sup> / <sub>8</sub> "	<b>AK-1009-22</b>

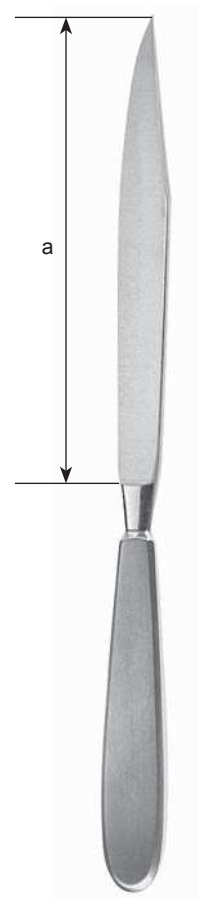

**LISTON**

A	
17,0 cm, 6 <sup>3</sup> / <sub>4</sub> "	<b>AK-1009-17</b>
20,0 cm, 8"	<b>AK-1009-20</b>
22,0 cm, 8 <sup>5</sup> / <sub>8</sub> "	<b>AK-1009-22</b>

Amputationsmesser, Messer für Autopsie  
 Amputation Knives, Post Mortem Knives  
 Cuchillos para amputación, Cuchillos para autopsia  
 Coltelli per amputazione, Coltelli per autopsia

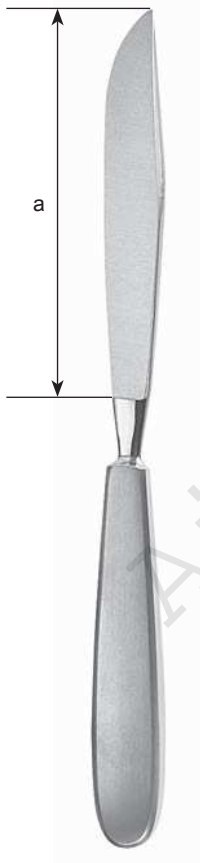

**LANGENBECK**  
 AK-1010-16

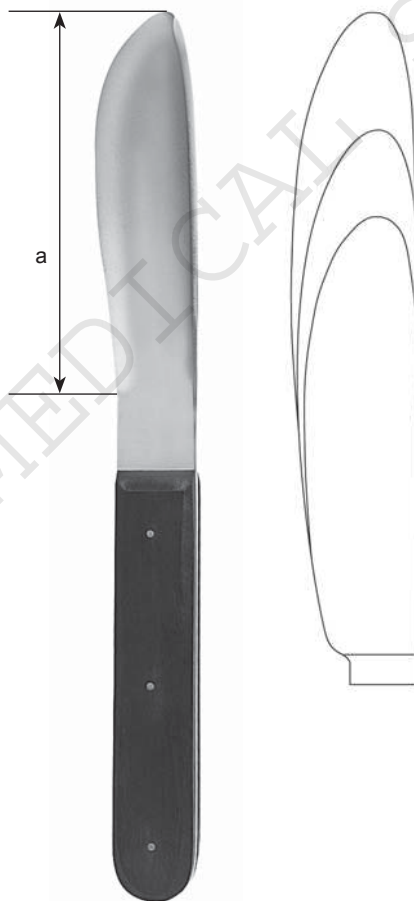

**WALB**

A	
11,0 cm, 4 1/2"	<b>AK-1010-11</b>
14,0 cm, 5 1/2"	<b>AK-1010-14</b>
17,0 cm, 6 3/4"	<b>AK-1010-17</b>

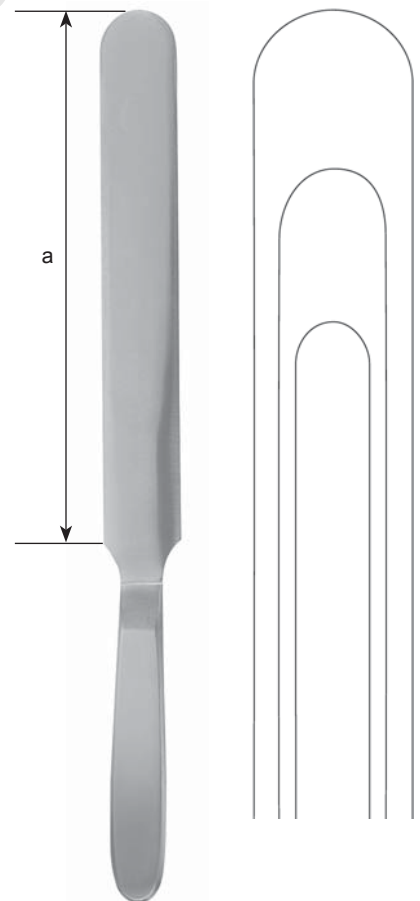

**VIRCHOW**

A	
16,0 cm, 6 1/4"	<b>AK-1011-16</b>
20,0 cm, 8"	<b>AK-1011-20</b>
24,0 cm, 9 1/2"	<b>AK-1011-24</b>

Amputationsmesser, Dermatomye  
Amputation Knives, Dermatomyes  
Cuchillos para amputación, Dermátomos  
Coltelli per amputazione, Dermatomyi



**LANGENBECK**  
18,0 cm, 7"  
AK-1011-55



mit Schaber  
with raspatory  
con periostótomo  
con raschiatoio

**CARTILAGE**  
17,5 cm, 6<sup>5</sup>/<sub>8</sub>"  
AK-1011-65



Haut-Spannplatten  
Skin straightening plate  
Placa para extender la piel  
Placca per stendere la pelle

**AK-1011-30**

**Resektionsmesser  
Resection Knives  
Cuchillos para resección  
Coltelli per resezione**

**AK-1012-19**  
Ersatzklinge  
Spare blade  
Hoja de repuesto  
Lama di ricambio



**SILVER**  
19 cm, 7 1/2"  
AK-1013-19

**AK-1012-30**  
Ersatzklinge  
Spare blade  
Hoja de repuesto  
Lama di ricambio



**BRAITHWAITE**  
30,0 cm, 12"  
AK-1013-30

**AK-1012-35**  
Ersatzklinge  
Spare blade  
Hoja de repuesto  
Lama di ricambio



**HUMBY**  
35,0 cm, 14"  
AK-1013-35

**AK-1012-30**  
Ersatzklinge  
Spare blade  
Hoja de repuesto  
Lama di ricambio



**SCHINK**  
30,0 cm, 12"  
AK-1013-30

**Scheren**  
**Scissors**  
**Tijeras**  
**Forbici**



Chirurgische Scheren  
Surgical Scissors  
Tijeras para cirugía  
Forbici per chirurgia



STANDARD	
10,5 cm, 4 <sup>1</sup> / <sub>4</sub> "	AK-1014-10
11,5 cm, 4 <sup>1</sup> / <sub>2</sub> "	AK-1014-11
13,0 cm, 5"	AK-1014-13
14,5 cm, 5 <sup>3</sup> / <sub>4</sub> "	AK-1014-14
15,5 cm, 6"	AK-1014-15
16,5 cm, 6 <sup>1</sup> / <sub>2</sub> "	AK-1014-16
17,5 cm, 6 <sup>5</sup> / <sub>8</sub> "	AK-1014-17
18,5 cm, 7 <sup>1</sup> / <sub>4</sub> "	AK-1014-18
20,0 cm, 8"	AK-1014-20



STANDARD	
10,5 cm, 4 <sup>1</sup> / <sub>4</sub> "	AK-1015-10
11,5 cm, 4 <sup>1</sup> / <sub>2</sub> "	AK-1015-11
13,0 cm, 5"	AK-1015-13
14,5 cm, 5 <sup>3</sup> / <sub>4</sub> "	AK-1015-14
15,5 cm, 6"	AK-1015-15
16,5 cm, 6 <sup>1</sup> / <sub>2</sub> "	AK-1015-16
17,5 cm, 6 <sup>5</sup> / <sub>8</sub> "	AK-1015-17
18,5 cm, 7 <sup>1</sup> / <sub>4</sub> "	AK-1015-18
20,0 cm, 8"	AK-1015-20



STANDARD	
10,5 cm, 4 <sup>1</sup> / <sub>4</sub> "	AK-1016-10
11,5 cm, 4 <sup>1</sup> / <sub>2</sub> "	AK-1016-11
13,0 cm, 5"	AK-1016-13
14,5 cm, 5 <sup>3</sup> / <sub>4</sub> "	AK-1016-14
15,5 cm, 6"	AK-1016-15
16,5 cm, 6 <sup>1</sup> / <sub>2</sub> "	AK-1016-16
17,5 cm, 6 <sup>5</sup> / <sub>8</sub> "	AK-1016-17
18,5 cm, 7 <sup>1</sup> / <sub>4</sub> "	AK-1016-18
20,0 cm, 8"	AK-1016-20



STANDARD	
10,5 cm, 4 <sup>1</sup> / <sub>4</sub> "	AK-1017-10
11,5 cm, 4 <sup>1</sup> / <sub>2</sub> "	AK-1017-11
13,0 cm, 5"	AK-1017-13
14,5 cm, 5 <sup>3</sup> / <sub>4</sub> "	AK-1017-14
15,5 cm, 6"	AK-1017-15
16,5 cm, 6 <sup>1</sup> / <sub>2</sub> "	AK-1017-16
17,5 cm, 6 <sup>5</sup> / <sub>8</sub> "	AK-1017-17
18,5 cm, 7 <sup>1</sup> / <sub>4</sub> "	AK-1017-18
20,0 cm, 8"	AK-1017-20



STANDARD	
10,5 cm, 4 <sup>1</sup> / <sub>4</sub> "	<b>AK-1018-10</b>
11,5 cm, 4 <sup>1</sup> / <sub>2</sub> "	<b>AK-1018-11</b>
13,0 cm, 5"	<b>AK-1018-13</b>
14,5 cm, 5 <sup>3</sup> / <sub>4</sub> "	<b>AK-1018-14</b>
15,5 cm, 6"	<b>AK-1018-15</b>
16,5 cm, 6 <sup>1</sup> / <sub>2</sub> "	<b>AK-1018-16</b>
17,5 cm, 6 <sup>5</sup> / <sub>8</sub> "	<b>AK-1018-17</b>
18,5 cm, 7 <sup>1</sup> / <sub>4</sub> "	<b>AK-1018-18</b>
20,0 cm, 8"	<b>AK-1018-20</b>



STANDARD	
10,5 cm, 4 <sup>1</sup> / <sub>4</sub> "	<b>AK-1020-10</b>
11,5 cm, 4 <sup>1</sup> / <sub>2</sub> "	<b>AK-1020-11</b>
13,0 cm, 5"	<b>AK-1020-13</b>
14,5 cm, 5 <sup>3</sup> / <sub>4</sub> "	<b>AK-1020-14</b>
15,5 cm, 6"	<b>AK-1020-15</b>
16,5 cm, 6 <sup>1</sup> / <sub>2</sub> "	<b>AK-1020-16</b>
17,5 cm, 6 <sup>5</sup> / <sub>8</sub> "	<b>AK-1020-17</b>
18,5 cm, 7 <sup>1</sup> / <sub>4</sub> "	<b>AK-1020-18</b>
20,0 cm, 8"	<b>AK-1020-20</b>



DEAVER	
12,0 cm, 4 <sup>3</sup> / <sub>4</sub> "	<b>AK-1021-12</b>
13,0 cm, 5"	<b>AK-1021-13</b>
14,5 cm, 5 <sup>3</sup> / <sub>4</sub> "	<b>AK-1021-14</b>



DEAVER	
12,0 cm, 4 <sup>3</sup> / <sub>4</sub> "	<b>AK-1022-12</b>
13,0 cm, 5"	<b>AK-1022-13</b>
14,5 cm, 5 <sup>3</sup> / <sub>4</sub> "	<b>AK-1022-14</b>



**Präparierscheren**  
**Dissecting Scissors**  
**Tijeras de disección**  
**Forbici per dissezione**



**DEAVER**  
 12,0 cm, 4<sup>3</sup>/<sub>4</sub>" **AK-1023-12**  
 13,0 cm, 5" **AK-1023-13**  
 14,5 cm, 5<sup>3</sup>/<sub>4</sub>" **AK-1023-14**



**DEAVER**  
 12,0 cm, 4<sup>3</sup>/<sub>4</sub>" **AK-1024-12**  
 13,0 cm, 5" **AK-1024-13**  
 14,5 cm, 5<sup>3</sup>/<sub>4</sub>" **AK-1024-14**



**DEAVER**  
 12,0 cm, 4<sup>3</sup>/<sub>4</sub>" **AK-1025-12**  
 13,0 cm, 5" **AK-1025-13**  
 14,5 cm, 5<sup>3</sup>/<sub>4</sub>" **AK-1025-14**



**DEAVER**  
 12,0 cm, 4<sup>3</sup>/<sub>4</sub>" **AK-1026-12**  
 13,0 cm, 5" **AK-1026-13**  
 14,5 cm, 5<sup>3</sup>/<sub>4</sub>" **AK-1026-14**



**GRAZIL**  
 13,0 cm, 5" **AK-1027-13**  
 14,5 cm, 5<sup>3</sup>/<sub>4</sub>" **AK-1027-14**



**GRAZIL**  
 13,0 cm, 5" **AK-1028-13**  
 14,5 cm, 5<sup>3</sup>/<sub>4</sub>" **AK-1028-14**



**GRAZIL**  
 13,0 cm, 5" **AK-1029-13**  
 14,5 cm, 5<sup>3</sup>/<sub>4</sub>" **AK-1029-14**



**GRAZIL**  
 13,0 cm, 5" **AK-1030-13**  
 14,5 cm, 5<sup>3</sup>/<sub>4</sub>" **AK-1030-14**

**Präparierscheren**  
**Dissecting Scissors**  
**Tijeras de disección**  
**Forbici per dissezione**



**GRAZIL**  
 13,0 cm, 5" **AK-1031-13**  
 14,5 cm, 5<sup>3</sup>/<sub>4</sub>" **AK-1031-14**



**GRAZIL**  
 13,0 cm, 5" **AK-1032-13**  
 14,5 cm, 5<sup>3</sup>/<sub>4</sub>" **AK-1032-14**

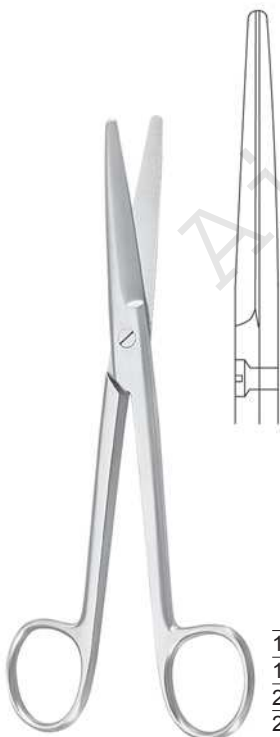

**MAYO**  
 14,5 cm, 5<sup>3</sup>/<sub>4</sub>" **AK-1033-14**  
 17,0 cm, 6<sup>3</sup>/<sub>4</sub>" **AK-1033-17**  
 23,0 cm, 9" **AK-1033-23**  
 28,0 cm, 11" **AK-1033-28**

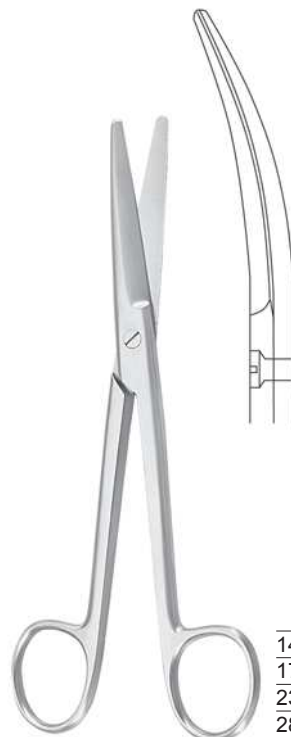

**MAYO**  
 14,5 cm, 5<sup>3</sup>/<sub>4</sub>" **AK-1034-14**  
 17,0 cm, 6<sup>3</sup>/<sub>4</sub>" **AK-1034-17**  
 23,0 cm, 9" **AK-1034-23**  
 28,0 cm, 11" **AK-1034-28**



**MAYO-STILE**

15,0 cm, 6"	<b>AK-1035-15</b>
17,0 cm, 6 <sup>3</sup> / <sub>4</sub> "	<b>AK-1035-17</b>
19,5 cm, 7 <sup>3</sup> / <sub>4</sub> "	<b>AK-1035-19</b>
21,0 cm, 8 <sup>1</sup> / <sub>4</sub> "	<b>AK-1035-21</b>



**MAYO-STILE**

15,0 cm, 6"	<b>AK-1036-15</b>
17,0 cm, 6 <sup>3</sup> / <sub>4</sub> "	<b>AK-1036-17</b>
19,5 cm, 7 <sup>3</sup> / <sub>4</sub> "	<b>AK-1036-19</b>
21,0 cm, 8 <sup>1</sup> / <sub>4</sub> "	<b>AK-1036-21</b>



**AK-1037-17**

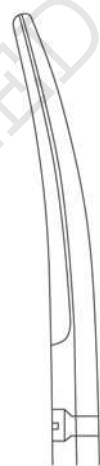

**AK-1038-17**

**MAYO-NOBLE**  
 17,0 cm, 6<sup>3</sup>/<sub>4</sub>"



**FOMON**

13,5 cm, 5<sup>3</sup>/<sub>8</sub>" **AK-1039-13**

**Präparierscheren**  
**Dissecting Scissors**  
**Tijeras de disección**  
**Forbici per dissezione**



**BABY-METZENBAUM**  
 11,5 cm, 4½"



AK-1040-11



AK-1041-11



**METZENBAUM**  
 14,5 cm, 5¾"



AK-1042-14

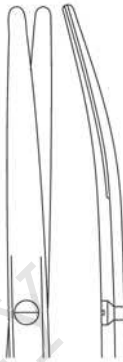

AK-1043-14



**METZENBAUM**  
 14,5 cm, 5¾"

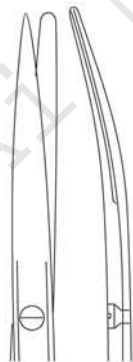

AK-1044-14



**METZENBAUM**  
 14,5 cm, 5¾"

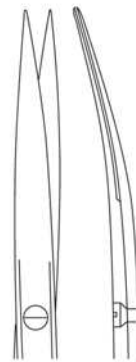

AK-1045-14

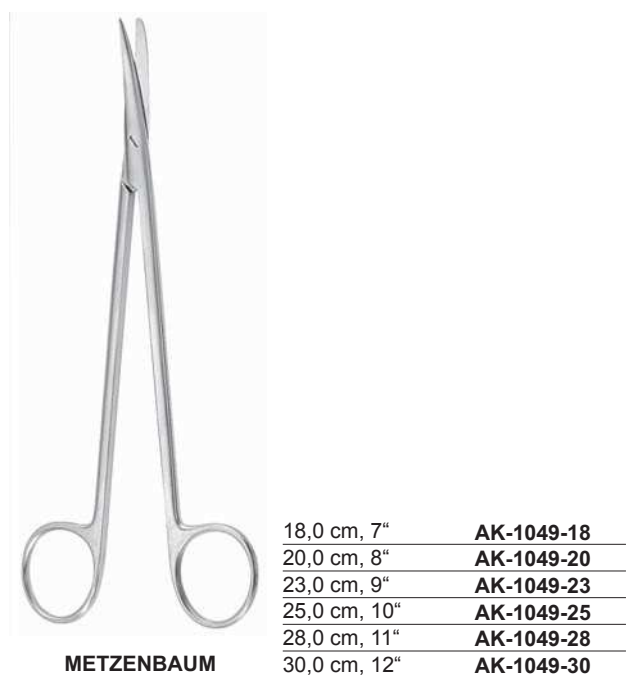
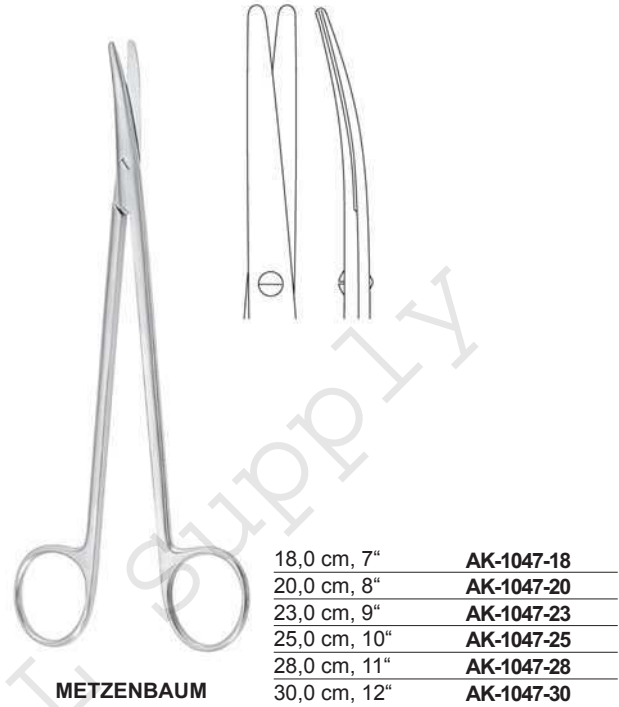

**Präparierscheren**  
**Dissecting Scissors**  
**Tijeras de disección**  
**Forbici per dissezione**

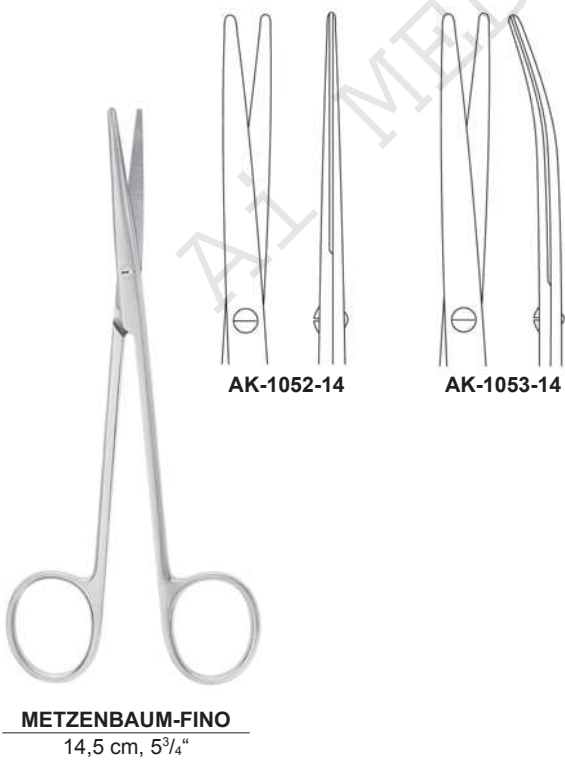
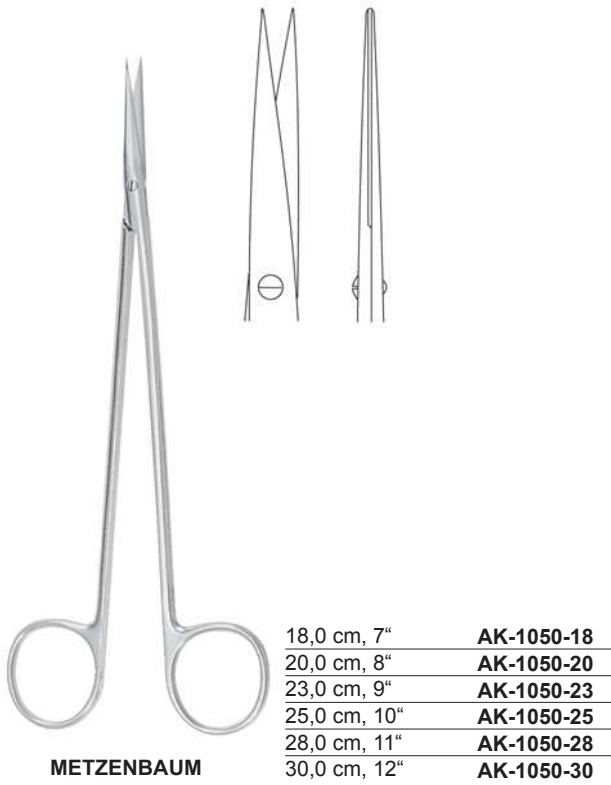

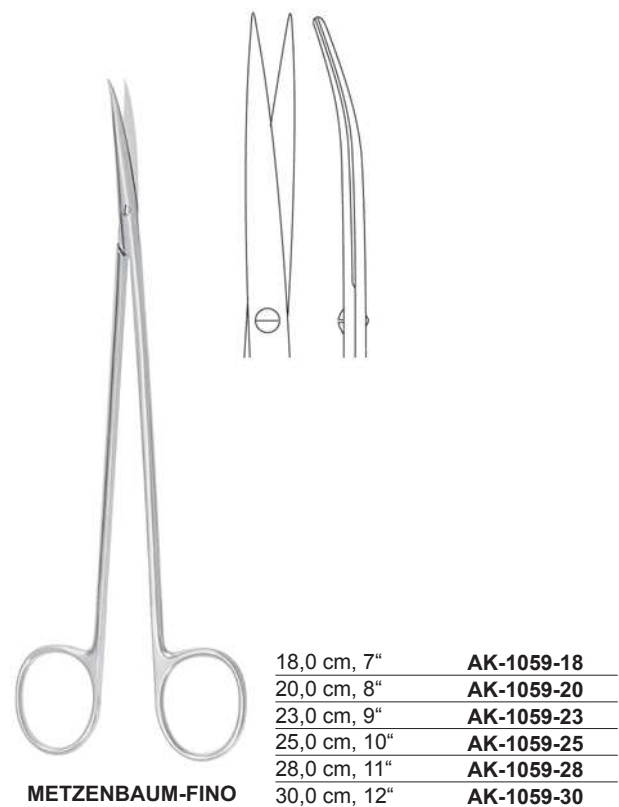
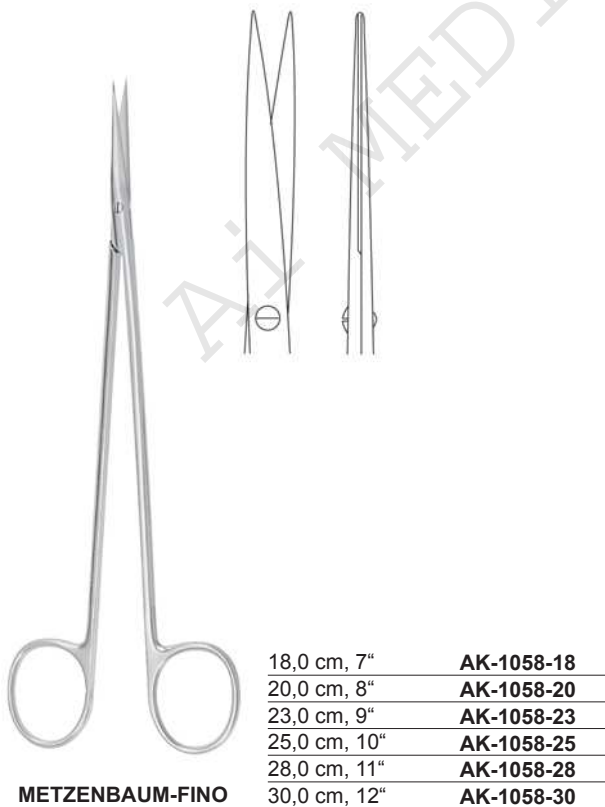
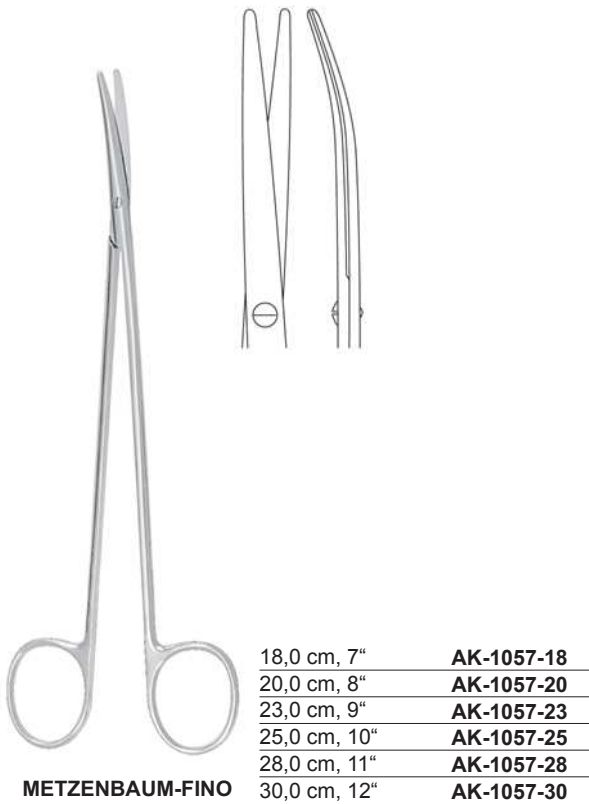



**Präparierscheren**  
**Dissecting Scissors**  
**Tijeras de disección**  
**Forbici per dissezione**

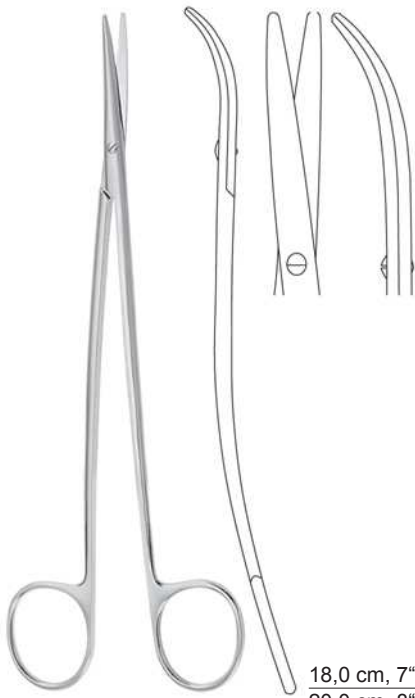

**METZENBAUM-FINO S**

18,0 cm, 7"  
 20,0 cm, 8"  
 23,0 cm, 9"

**AK-1060-18**  
**AK-1060-20**  
**AK-1060-23**



**METZENBAUM-FINOS**

18,0 cm, 7"  
 20,0 cm, 8"  
 23,0 cm, 9"

**AK-1061-18**  
**AK-1061-20**  
**AK-1061-23**



**METZENBAUM-LAHEY**  
 14,0 cm, 5½" **AK-1062-14**



**TOENNIS-ADSON**  
 17,0 cm, 6¾" **AK-1063-17**

Präparierscheren  
 Dissecting Scissors  
 Tijeras de disección  
 Forbici per dissezione

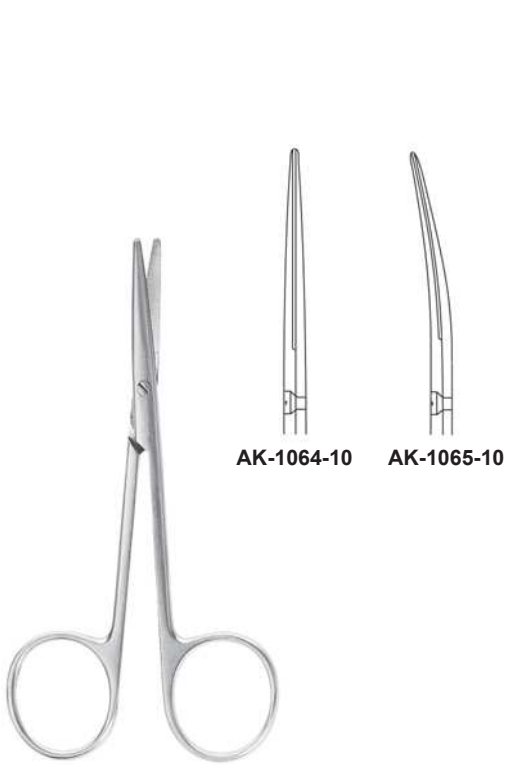

AK-1064-10    AK-1065-10

**BABY-LEXER**  
 10,0 cm, 4"



**LEXER**                      16,0 cm, 6<sup>1</sup>/<sub>4</sub>"                      **AK-1066-16**  
 21,0 cm, 8<sup>1</sup>/<sub>4</sub>"                      **AK-1066-21**



**LEXER**                      16,0 cm, 6<sup>1</sup>/<sub>4</sub>"                      **AK-1069-16**  
 21,0 cm, 8<sup>1</sup>/<sub>4</sub>"                      **AK-1069-21**

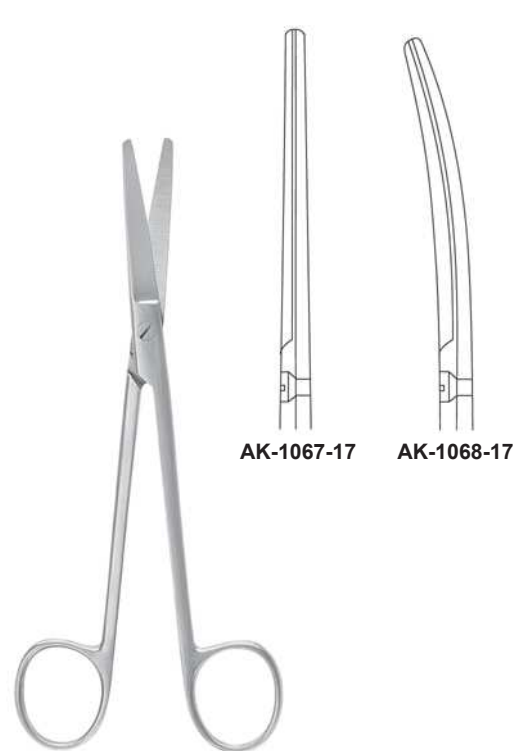

**MIXTER**  
 17,0 cm, 6<sup>3</sup>/<sub>4</sub>"

**Präparierscheren, feine chirurgische Scheren**  
**Dissecting Scissors, fine surgical scissors**  
**Tijeras de disección, tijeras finas para cirugía**  
**Forbici per dissezione, forbici fine per chirurgia**



**KILNER (RAGNELL)**

12,0 cm, 4 <sup>3</sup> / <sub>4</sub> "	<b>AK-1070-12</b>
15,0 cm, 6"	<b>AK-1070-15</b>
18,0 cm, 7"	<b>AK-1070-18</b>
20,0 cm, 8"	<b>AK-1070-20</b>



**KILNER (RAGNELL)**

12,0 cm, 4 <sup>3</sup> / <sub>4</sub> "	<b>AK-1071-12</b>
15,0 cm, 6"	<b>AK-1071-15</b>
18,0 cm, 7"	<b>AK-1071-18</b>
20,0 cm, 8"	<b>AK-1071-20</b>



**REYNOLDS**

15,0 cm, 6"	<b>AK-1072-15</b>
18,0 cm, 7"	<b>AK-1072-18</b>



**REYNOLDS**

15,0 cm, 6"	<b>AK-1073-15</b>
18,0 cm, 7"	<b>AK-1073-18</b>
20,0 cm, 8"	<b>AK-1073-20</b>
23,0 cm, 9"	<b>AK-1073-23</b>
25,0 cm, 10"	<b>AK-1073-25</b>

Feine chirurgische Scheren  
 Fine surgical scissors  
 Tijeras finas para cirugía  
 Forbici fine per chirurgia



**THOREK**

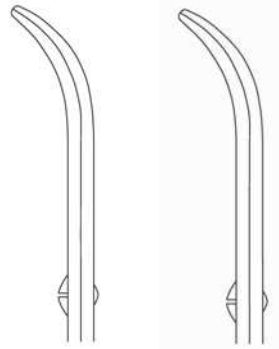

19,0 cm, 7 1/2"  
**AK-1074-19**

25,0 cm, 10"  
**AK-1075-25**



15,0 cm, 6"

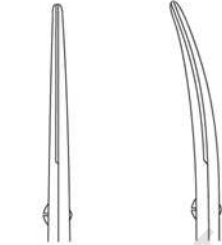

**AK-1076-15**

**AK-1077-15**

Nerv-Präparierscheren  
 Nerve dissecting scissors  
 Tijeras para nervios  
 Forbici per dissezione di nervi



**SANVENERO**  
 14,0 cm, 5 1/2"

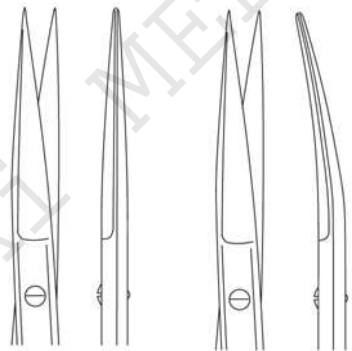

**AK-1078-14**

**AK-1079-14**



**JOSEPH**  
 14,0 cm, 5 1/2"

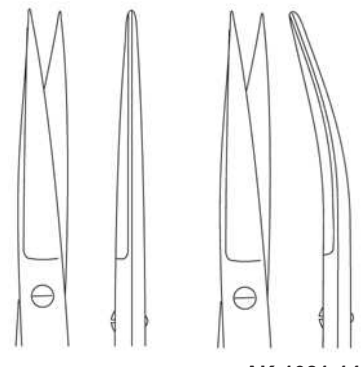

**AK-1080-14**

**AK-1081-14**

Feine chirurgische Scheren  
 Fine surgical scissors  
 Tijeras finas para cirugía  
 Forbici fine per chirurgia

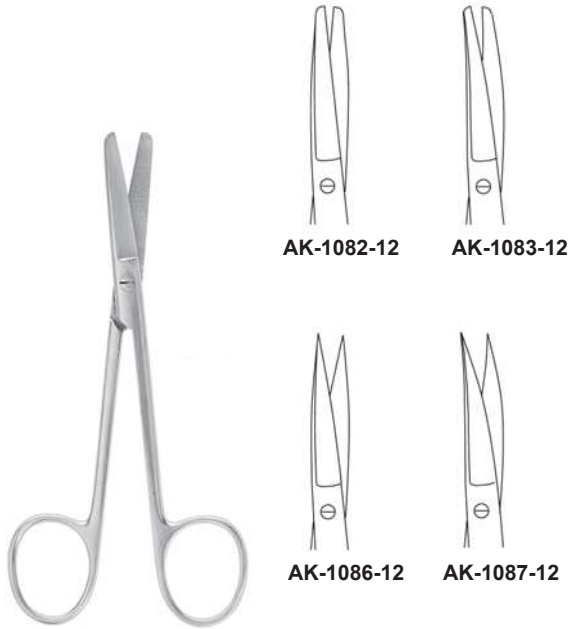

**WAGNER**  
 12,0 cm, 4<sup>3</sup>/<sub>4</sub>"



**STRABISMUS**  
 11,5 cm, 4<sup>1</sup>/<sub>2</sub>"

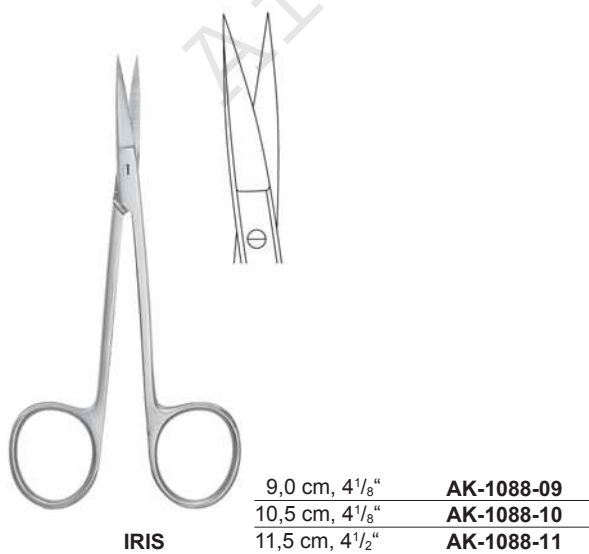

**IRIS**  
 9,0 cm, 4<sup>1</sup>/<sub>8</sub>" **AK-1088-09**  
 10,5 cm, 4<sup>1</sup>/<sub>8</sub>" **AK-1088-10**  
 11,5 cm, 4<sup>1</sup>/<sub>2</sub>" **AK-1088-11**

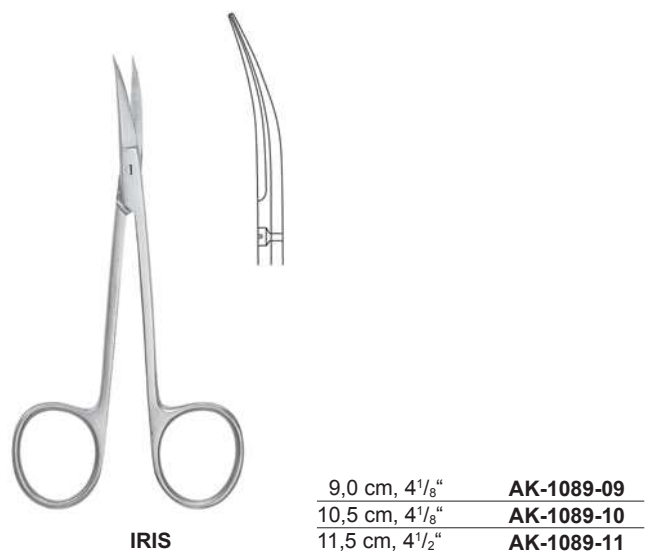

**IRIS**  
 9,0 cm, 4<sup>1</sup>/<sub>8</sub>" **AK-1089-09**  
 10,5 cm, 4<sup>1</sup>/<sub>8</sub>" **AK-1089-10**  
 11,5 cm, 4<sup>1</sup>/<sub>2</sub>" **AK-1089-11**

Feine chirurgische Scheren  
 Fine surgical scissors  
 Tijeras finas para cirugía  
 Forbici fine per chirurgia



IRIS

10,5 cm, 4<sup>1</sup>/<sub>8</sub>"  
 11,5 cm, 4<sup>1</sup>/<sub>2</sub>"

AK-1090-10  
 AK-1090-11



IRIS

10,5 cm, 4<sup>1</sup>/<sub>8</sub>"  
 11,5 cm, 4<sup>1</sup>/<sub>2</sub>"

AK-1091-10  
 AK-1091-11



11,5 cm, 4<sup>1</sup>/<sub>2</sub>"  
 AK-1092-11



11,5 cm, 4<sup>1</sup>/<sub>2</sub>"  
 AK-1093-11

Feine chirurgische Scheren  
Fine surgical scissors  
Tijeras finas para cirugía  
Forbici fine per chirurgia



AK-1094-12

12,0 cm, 4<sup>3</sup>/<sub>4</sub>"



AK-1095-12



MOD. BONN  
8,0 cm, 3<sup>1</sup>/<sub>4</sub>"  
AK-1096-08



MOD. BONN  
8,0 cm, 3<sup>1</sup>/<sub>4</sub>"  
AK-1097-08



MOD. BONN  
8,0 cm, 3<sup>1</sup>/<sub>4</sub>"  
AK-1098-08



**BROPHY (SULLIVAN)**  
 14,0 cm, 5½"  
 AK-1099-14



**BROPHY (SULLIVAN)**  
 14,0 cm, 5½"  
 AK-1100-14

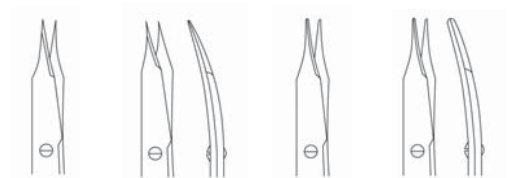

10,5 cm, 4⅛"	<b>AK-1101-10</b>	<b>AK-1102-10</b>	<b>AK-1103-10</b>	<b>AK-1104-10</b>
11,5 cm, 4½"	<b>AK-1101-11</b>	<b>AK-1102-11</b>	<b>AK-1103-11</b>	<b>AK-1104-11</b>



**LANDOLT**  
 12,5 cm, 5"



**STEVENS**



**Chirurgische Scheren**  
**Surgical scissors**  
**Tijeras para cirugía**  
**Forbici per chirurgia**



Inzisionsscheren  
 Incision scissors  
 Tijeras para incisión  
 Forbici vascolare e per fistole

13,0 cm, 5" **AK-1108-13**  
 14,5 cm, 5<sup>3</sup>/<sub>4</sub>" **AK-1108-14**



Inzisionsscheren  
 Incision scissors  
 Tijeras para incisión  
 Forbici vascolare e per fistole

**AK-1109-16**  
 16,5 cm, 36<sup>1</sup>/<sub>2</sub>"



**RICHTER**  
 14,5 cm, 5<sup>3</sup>/<sub>4</sub>"  
**AK-1110-14**



**LAWSON TAIT**  
 12,5 cm, 5"  
**AK-1111-12**



**FERGUSSON**  
 16,5 cm, 6<sup>1</sup>/<sub>4</sub>" **AK-1112-16**  
 18,0 cm, 7" **AK-1112-18**



**TOENNIS**  
 18,0 cm, 7"  
**AK-1113-18**

Chirurgische Scheren, Ligaturscheren  
 Surgical scissors, Ligature Scissors  
 Tijeras para cirugía, Tijeras para ligaduras  
 Forbici per chirurgia, Forbici per legature



**TOENNIS**  
 18,0 cm, 7"  
 AK-1114-18



**HALLE**  
 19,0 cm, 7½"  
 AK-1115-19

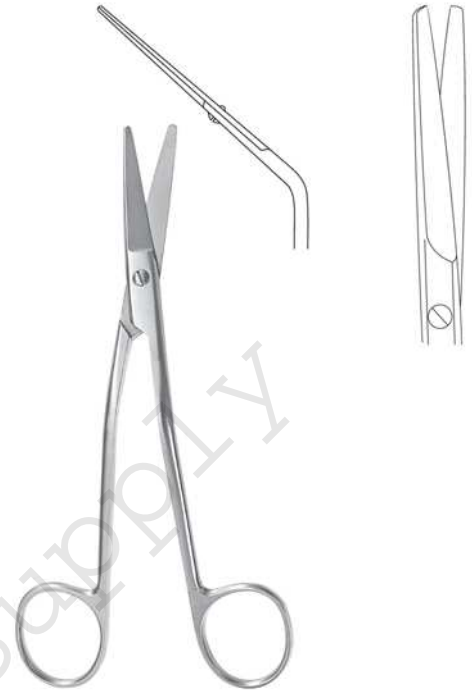

**FOMON**  
 15,0 cm, 6"  
 AK-1116-15



**SPENCER**  
 9,0 cm, 4⅞" AK-1117-09  
 10,5 cm, 4⅞" AK-1117-10  
 13,0 cm, 5" AK-1117-13



**LITTAUER**  
 11,5 cm, 4¼" AK-1118-11  
 14,0 cm, 5½" AK-1118-14



**BUCK**

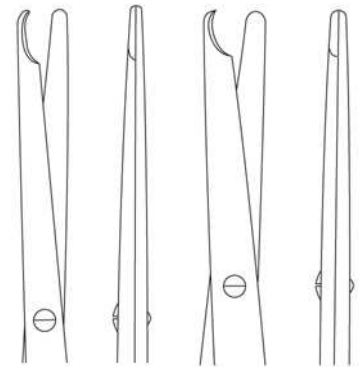

14,5 cm, 5¾"  
 AK-1119-14

18,0 cm, 7"  
 AK-1120-18

**Ligaturscheren, Neurochirurgische Scheren**  
**Ligature Scissors, Neurosurgical Scissors**  
**Tijeras para ligaduras, Tijeras para Neurocirugía**  
**Forbici per legature, Forbici per Neurochirurgia**

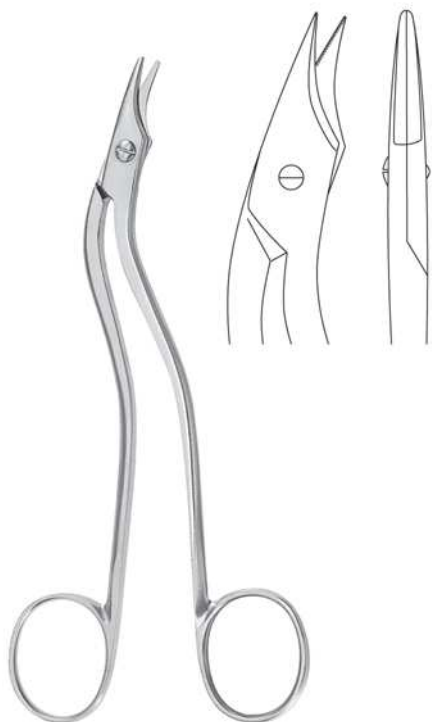

**HEATH**  
 16,0 cm, 6<sup>1</sup>/<sub>4</sub>"  
**AK-1121-16**



**NORTHBENT**  
 9,0 cm, 3<sup>1</sup>/<sub>2</sub>"  
**AK-1122-09**



**NORTHBENT**  
 13,0 cm, 5"  
**AK-1123-13**



**EISELSBERG**  
 12,0 cm, 4<sup>3</sup>/<sub>4</sub>"  
**AK-1124-12**



**STRULLY**  
 22,0 cm, 8<sup>5</sup>/<sub>8</sub>"  
**AK-1125-22**

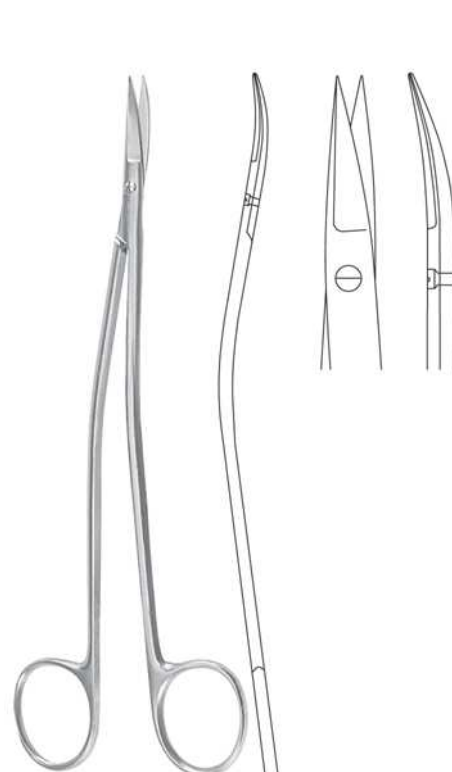

**DANDY**  
 17,0 cm, 6<sup>3</sup>/<sub>4</sub>"  
**AK-1126-17**

Neurochirurgische Scheren, Tonsillenscheren, Nasenscheren  
 Neurosurgical Scissors, Tonsil Scissors, Nasal Scissors  
 Tijeras para Neurocirugía, Tijeras para amígdalas, Tijeras para el tabique nasal  
 Forbici per Neurochirurgia, Forbici per tonsille, Forbici per il setto nasale



**SCHMIEDEN-TAYLOR**  
 17,0 cm, 6<sup>3</sup>/<sub>4</sub>"  
 AK-1127-17



**LINCOLN**  
 17,0 cm, 6<sup>3</sup>/<sub>4</sub>"

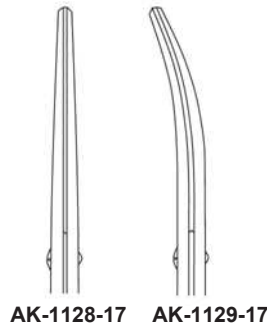

AK-1128-17 AK-1129-17



**HEYMANN**  
 18,0 cm, 7"  
 AK-1130-18



**COTTLE**  
 16,0 cm, 6<sup>1</sup>/<sub>4</sub>"  
 AK-1131-16

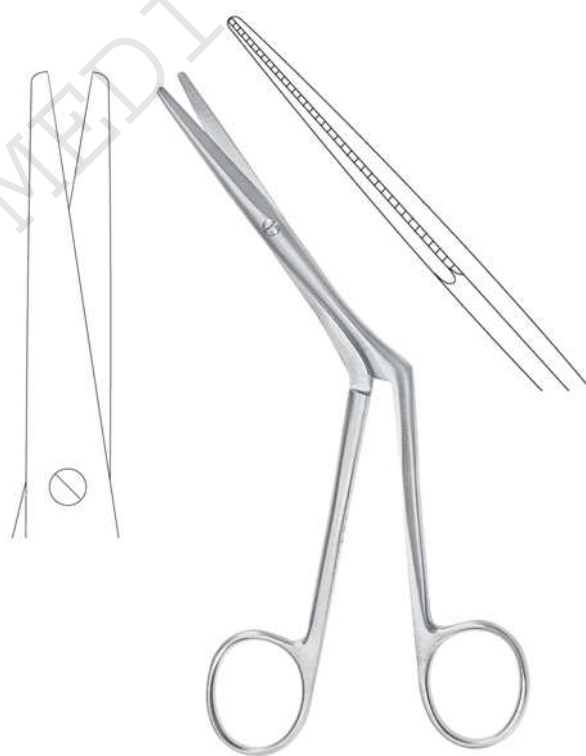

**KIRSTEN**  
 18,0 cm, 7"  
 AK-1132-18



**CAPLAN**  
 22,0 cm, 8<sup>5</sup>/<sub>8</sub>"  
 AK-1133-22

**Tonsillenscheren, Nasenscheren, Gefäßscheren**  
**Tonsil Scissors, Nasal Scissors, Vascular Scissors**  
**Tijeras para amígdalas, Tijeras para el tabique nasal, Tijeras vasculares**  
**Forbici per tonsille, Forbici per il setto nasale, Forbici vascolari**



**BOETTCHER**  
 18,0 cm, 7"  
**AK-1134-18**



**PRINCE**  
 17,5 cm, 6<sup>5</sup>/<sub>8</sub>"  
**AK-1135-17**

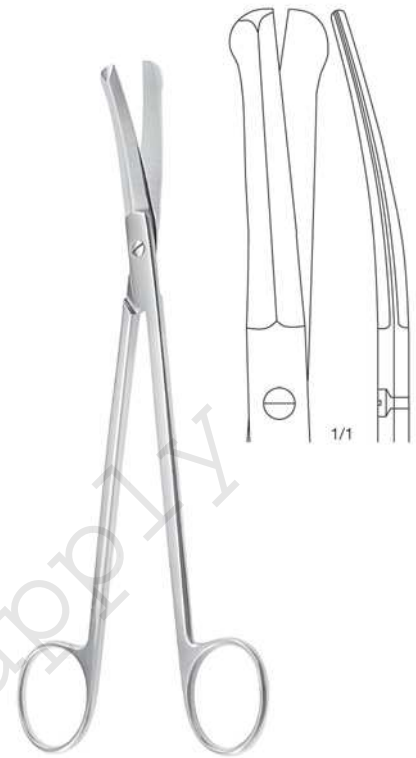

**GOOD**  
 19,0 cm, 7<sup>1</sup>/<sub>2</sub>"  
**AK-1136-19**



**CARTILAGE**  
 20,0 cm, 8"  
**AK-1137-20**



**DE BAKEY**

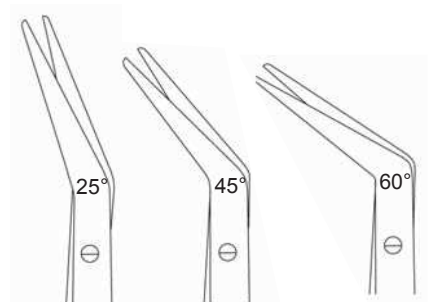

17,5 cm, 6 <sup>5</sup> / <sub>8</sub> "	<b>AK-1138-25</b>	<b>AK-1143-45</b>	<b>AK-1148-60</b>
19,5 cm, 7 <sup>3</sup> / <sub>4</sub> "	<b>AK-1139-25</b>	<b>AK-1144-45</b>	<b>AK-1149-60</b>
21,0 cm, 8 <sup>1</sup> / <sub>4</sub> "	<b>AK-1140-25</b>	<b>AK-1145-45</b>	<b>AK-1150-60</b>
23,0 cm, 9"	<b>AK-1141-25</b>	<b>AK-1146-45</b>	<b>AK-1151-60</b>
28,0 cm, 11"	<b>AK-1142-25</b>	<b>AK-1147-45</b>	<b>AK-1152-60</b>



**POTTS-SMITH**  
 18,0 cm, 7"  
 AK-1143-18

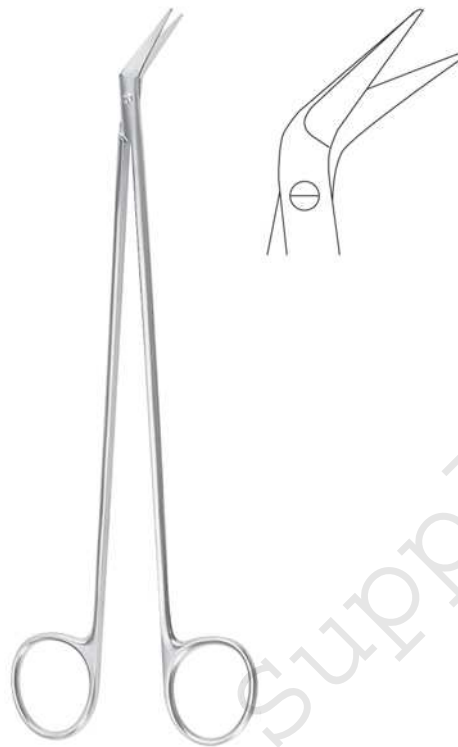

**POTTS DE MARTEL**  
 21,0 cm, 8 1/4" **AK-1144-21**  
 24,0 cm, 9 1/2" **AK-1144-24**



**DIETRICH-HEGEMANN**  
 19,0 cm, 7 1/2"

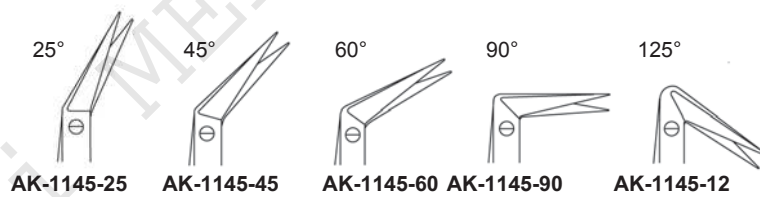

Gefäßscheren  
 Vascular Scissors  
 Tijeras vasculares  
 Forbici vascolari



**DIETRICH**  
 20,0 cm, 7 1/2"  
 AK-1148-12

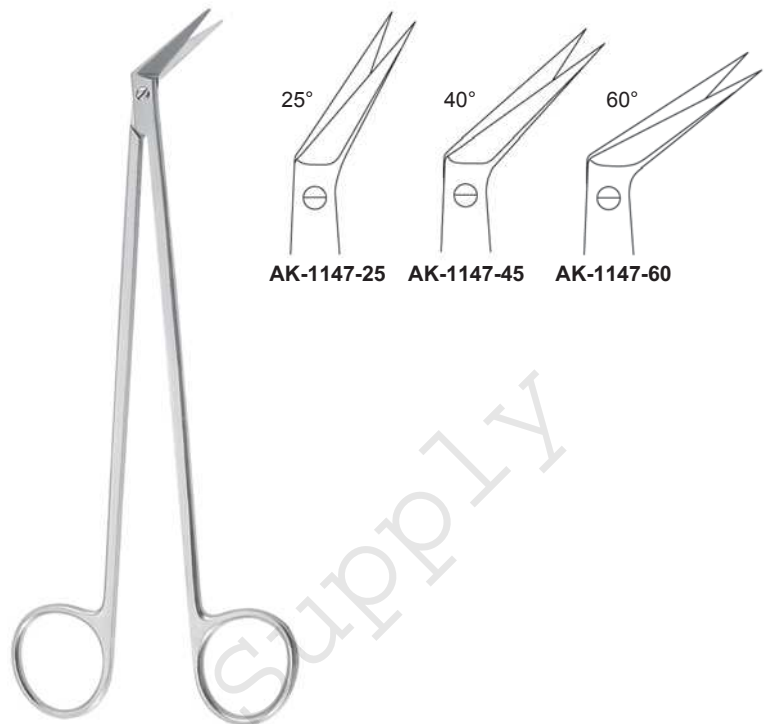

**POTTS-SMITH**  
 19,0 cm, 7 1/2"

25° AK-1147-25  
 40° AK-1147-45  
 60° AK-1147-60



**DE BAKEY**  
 15,5 cm, 6"  
 AK-1149-15



**DE BAKEY**  
 15,5 cm, 6"  
 AK-1150-15



**DE BAKEY**  
 15,5 cm, 6"  
 AK-1151-15

Gefäßscheren, Gynäkologische Scheren  
 Vascular Scissors, Gynecology scissors  
 Tijeras vasculares, Tijeras para ginecología  
 Forbici vascolari, Forbici per ginecologia



**MC INDOE**  
 19,0 cm, 7½"  
 AK-1152-19



geknöpftes Blatt  
 probe-pointed blade  
 punta botonda  
 lame bottonuta

11,5 cm, 4½"  
 AK-1153-11



**CRAFOORD**  
 30,0 cm, 12"  
 AK-1154-30

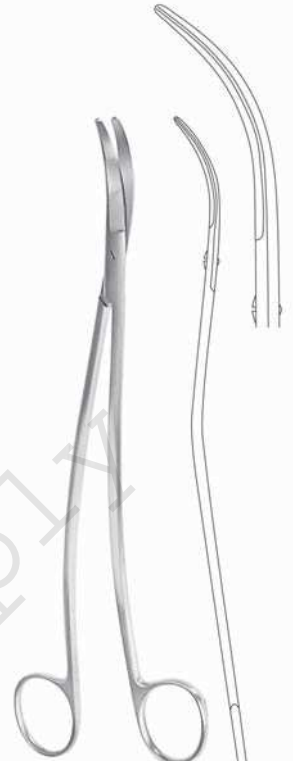

**SATINSKY**  
 15,5 cm, 9⅝"  
 AK-1155-24



**KLINGENBERG-LOTH**  
 23,0 cm, 9"  
 AK-1162-23



**SIMS**



20,0 cm, 8"	<b>AK-1156-20</b>	<b>AK-1157-20</b>	<b>AK-1158-20</b>
23,0 cm, 9"	<b>AK-1159-23</b>	<b>AK-1160-23</b>	<b>AK-1161-23</b>



Gynäkologische Scheren  
 Gynecology scissors  
 Tijeras para ginecología  
 Forbici per ginecologia



**SIMS**

20,0 cm, 8"	<b>AK-1163-20</b>	<b>AK-1164-20</b>	<b>AK-1165-20</b>
23,0 cm, 9"	<b>AK-1166-23</b>	<b>AK-1167-23</b>	<b>AK-1168-23</b>

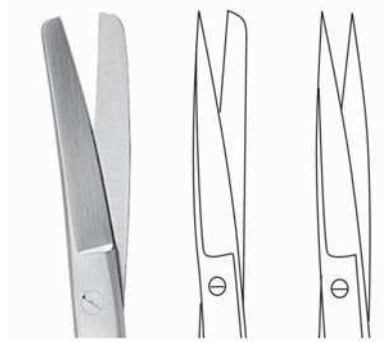

**SIEBOLD**  
 24,0 cm, 9½"



**BOZEMANN**  
 22,0 cm, 8¾"



**DOYEN**

16,0 cm, 6¼"	<b>AK-1171-16</b>	<b>AK-1172-16</b>	<b>AK-1173-16</b>
17,5 cm, 6⅝"	<b>AK-1174-17</b>	<b>AK-1175-17</b>	<b>AK-1176-16</b>



**KELLY**

16,0 cm, 6¼"	<b>AK-1177-16</b>
18,0 cm, 7"	<b>AK-1177-18</b>

Fistelscheren  
 Fistula scissors  
 Tijeras para fistulas  
 Forbici per fistole

Gynäkologische Scheren, Darmscheren  
 Gynecology scissors, Enterotomy Scissors  
 Tijeras para ginecología, Tijeras enterótomos  
 Forbici per ginecologia, Forbici per enterotomia



Fistelscheren  
 Fistula scissors  
 Tijeras para fistulas  
 Forbici per fistole

**KELLY**

16,0 cm, 6 <sup>1</sup> / <sub>4</sub> "	<b>AK-1179-16</b>
18,0 cm, 7"	<b>AK-1179-18</b>



**WERTHEIM**

19,5 cm, 7 <sup>3</sup> / <sub>4</sub> "	<b>AK-1180-19</b>
22,5 cm, 8 <sup>3</sup> / <sub>4</sub> "	<b>AK-1180-23</b>



**AK-1178-18**

**DUBOIS**

27,0 cm, 10 <sup>5</sup> / <sub>8</sub> "	<b>AK-1181-18</b>
---	-------------------



**DARMSCHERE**  
 21,0 cm, 8<sup>1</sup>/<sub>4</sub>"  
**AK-1182-21**



**DARMSCHERE**  
 21,0 cm, 8<sup>1</sup>/<sub>4</sub>"  
**AK-1183-21**



**DARMSCHERE  
 GEKNÖPFT**  
 21,0 cm, 8<sup>1</sup>/<sub>4</sub>"  
**AK-1184-21**



**LLOYD-DAVIES**  
 27,0 cm, 10<sup>5</sup>/<sub>8</sub>"  
**AK-1185-27**

Lungenlappen- und Rektumscheren, Lungenscheren, Dammscheren  
 Lobectomy and Rectal Scissors, Lobectomy Scissors, Episiotomy Scissors  
 Tijeras para lobectomía y recto, Tijera para lobectomía, Tijeras para episiotomía  
 Forbici per lobo polmonare e per il retto, Forbici per lobo, Forbici per episiotomia

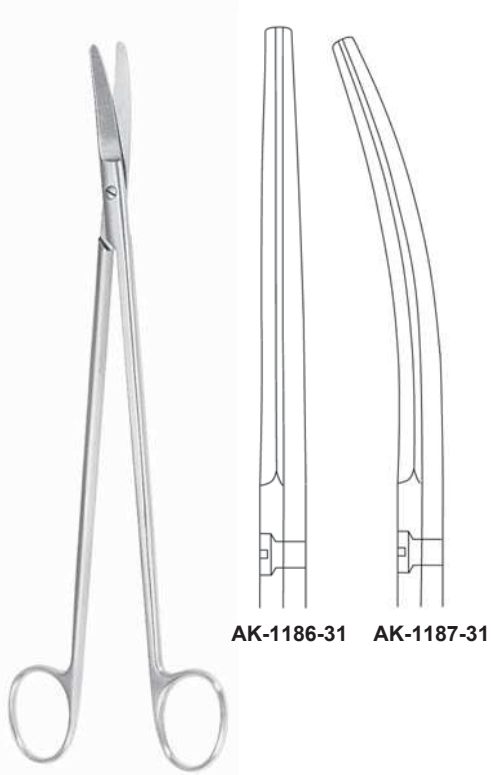

**AK-1186-31** **AK-1187-31**

**STIELZNER**  
31,0 cm, 12<sup>1</sup>/<sub>4</sub>"



**RECTAL**  
32,5 cm, 12<sup>3</sup>/<sub>4</sub>"  
**AK-1188-32**

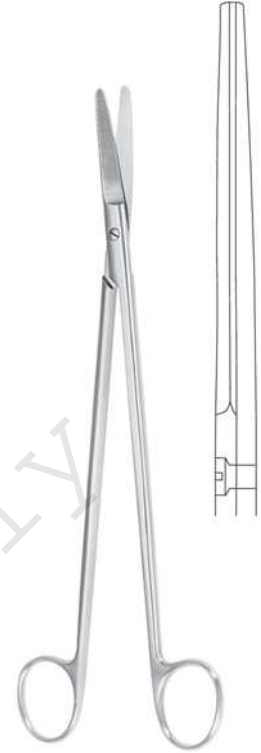

**WILLAUER**  
25,0 cm, 9<sup>3</sup>/<sub>4</sub>" **AK-1189-25**  
28,0 cm, 11" **AK-1189-28**

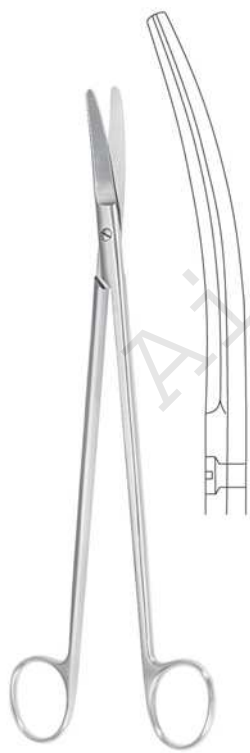

**WILLAUER**  
25,0 cm, 9<sup>3</sup>/<sub>4</sub>" **AK-1190-25**  
28,0 cm, 11" **AK-1190-28**



**POTTS-SMITH**  
19,0 cm, 7<sup>1</sup>/<sub>2</sub>"  
**AK-1191-19**



**FINOCHIETTO**  
32,5 cm, 10<sup>5</sup>/<sub>8</sub>"  
**AK-1192-27**

Lungenscheren, Dammscheren, Nabelschnurscheren  
 Lobectomy Scissors, Episiotomy Scissors, Umbilical Cord Scissors  
 Tijera para lobectomía, Tijeras para episiotomía, Tijeras umbilicales  
 Forbici per lobo, Forbici per episiotomia, Forbici ombelicali



**WALDMANN**  
 18,0 cm, 7"  
 AK-1193-18



**BRAUN-STADLER**  
 14,5 cm, 5<sup>3</sup>/<sub>4</sub>"      **AK-1194-14**  
 20,0 cm, 8"         **AK-1194-20**



**EPISIOTOMIE SCHERE**  
 20,0 cm, 8"  
 AK-1195-20



**MOD. USA**  
 10,5 cm, 4<sup>1</sup>/<sub>8</sub>"  
 AK-1196-10



**BUSCH**  
 13,5 cm, 5<sup>3</sup>/<sub>8</sub>"      **AK-1197-13**  
 16,0 cm, 6<sup>1</sup>/<sub>4</sub>"      **AK-1197-16**



**SCHUMACHER**  
 16,0 cm, 16<sup>1</sup>/<sub>4</sub>"  
 AK-1198-16

**Drahtscheren, Verband- und Kleiderstoffscheren**  
**Wire Scissors, Bandage and Cloth Scissors**  
**Cizallas corta-alambres, Tijeras para vendajes y tela**  
**Forbici taglia cavo, Forbici per bendaggi e vestiti**



gezahnt  
 serrated  
 dentada  
 dentata

**UNIVERSAL**  
 12,0 cm, 4<sup>3</sup>/<sub>4</sub>"  
**AK-1200-12**



**LISTER**

9,0 cm, 3 <sup>1</sup> / <sub>2</sub> "	<b>AK-1199-09</b>
11,0 cm, 4 <sup>3</sup> / <sub>8</sub> "	<b>AK-1199-11</b>
14,0 cm, 5 <sup>1</sup> / <sub>2</sub> "	<b>AK-1199-14</b>
18,0 cm, 7"	<b>AK-1199-18</b>
20,0 cm, 8"	<b>AK-1199-20</b>



**LISTER**

18,5 cm, 7 <sup>1</sup> / <sub>4</sub> "	<b>AK-1201-18</b>
21,0 cm, 8 <sup>1</sup> / <sub>4</sub> "	<b>AK-1201-21</b>



gezahnt  
 serrated  
 dentada  
 dentata

**LISTER-EXCENTRIC**

16,0 cm, 6 <sup>1</sup> / <sub>4</sub> "	<b>AK-1202-16</b>
19,0 cm, 7 <sup>1</sup> / <sub>2</sub> "	<b>AK-1202-19</b>



**BERGMANN**

23,0 cm, 9"	<b>AK-1203-23</b>
-------------	-------------------

Verband- und Kleiderstoffscheren, Gipsscheren  
 Bandage and Cloth Scissors, Plaster-of-Paris Shears  
 Tijeras para vendajes y tela, Cizallas para escayolas  
 Forbici per bendaggi e vestiti, Cesoie per gessi



**ESMARCH**

20,0 cm, 8" **AK-1204-20**  
 22,0 cm, 8<sup>5</sup>/<sub>8</sub>" **AK-1204-22**



**KNOWLES**

14,0 cm, 5<sup>1</sup>/<sub>2</sub>" **AK-1205-14**



gezahnt  
 serrated  
 dentada  
 dentata

**BRUNS**

24,0 cm, 9<sup>1</sup>/<sub>2</sub>" **AK-1206-24**  
**AK-1207-24**



**LORENZ**

23,0 cm, 9" **AK-1208-23**

bis 134°C autoklavierbar  
 autoclavable up to 134°C  
 esterilizable en autoclave hasta 134°C  
 Sterilizabile in autoclave fino 134°C



**SMITH  
 (MOD. USA)**

16,0 cm, 6<sup>1</sup>/<sub>4</sub>" **AK-1209-16**  
 18,0 cm, 7" **AK-1209-18**  
 20,0 cm, 8" **AK-1209-20**  
 23,0 cm, 9" **AK-1209-23**



gezahnt  
 serrated  
 dentada  
 dentata

**GIPSSCHERE**

20,0 cm, 8" **AK-1210-20**



gezahnt  
 serrated  
 dentada  
 dentata

**UNIVERSAL**

14,0 cm, 5<sup>1</sup>/<sub>2</sub>" **AK-1211-14**  
 16,0 cm, 6<sup>1</sup>/<sub>4</sub>" **AK-1211-16**  
 18,0 cm, 7" **AK-1211-18**

Chirurgische Scheren mit Hartmetallschneiden  
 Surgical Scissors with tungsten carbide edges  
 Tijeras para cirugía con filos de carburo tungsteno  
 Forbici per chirurgia con lame in carburo di tungsteno



**STANDARD**

14,5 cm, 5 <sup>3</sup> / <sub>4</sub> "	<b>AK-1212-14-TC</b>
16,5 cm, 6 <sup>1</sup> / <sub>2</sub> "	<b>AK-1212-16-TC</b>
18,5 cm, 7 <sup>1</sup> / <sub>4</sub> "	<b>AK-1212-18-TC</b>



**STANDARD**

14,5 cm, 5 <sup>3</sup> / <sub>4</sub> "	<b>AK-1213-14-TC</b>
16,5 cm, 6 <sup>1</sup> / <sub>2</sub> "	<b>AK-1213-16-TC</b>
18,5 cm, 7 <sup>1</sup> / <sub>4</sub> "	<b>AK-1213-18-TC</b>



**STANDARD**

14,5 cm, 5 <sup>3</sup> / <sub>4</sub> "	<b>AK-1214-14-TC</b>
16,5 cm, 6 <sup>1</sup> / <sub>2</sub> "	<b>AK-1214-16-TC</b>
18,5 cm, 7 <sup>1</sup> / <sub>4</sub> "	<b>AK-1214-18-TC</b>



**STANDARD**

14,5 cm, 5 <sup>3</sup> / <sub>4</sub> "	<b>AK-1215-14-TC</b>
16,5 cm, 6 <sup>1</sup> / <sub>2</sub> "	<b>AK-1215-16-TC</b>
18,5 cm, 7 <sup>1</sup> / <sub>4</sub> "	<b>AK-1215-18-TC</b>



**STANDARD**

14,5 cm, 5 <sup>3</sup> / <sub>4</sub> "	<b>AK-1216-14-TC</b>
16,5 cm, 6 <sup>1</sup> / <sub>2</sub> "	<b>AK-1216-16-TC</b>
18,5 cm, 7 <sup>1</sup> / <sub>4</sub> "	<b>AK-1216-18-TC</b>



**STANDARD**

14,5 cm, 5 <sup>3</sup> / <sub>4</sub> "	<b>AK-1217-14-TC</b>
16,5 cm, 6 <sup>1</sup> / <sub>2</sub> "	<b>AK-1217-16-TC</b>
18,5 cm, 7 <sup>1</sup> / <sub>4</sub> "	<b>AK-1217-18-TC</b>

Chirurgische Scheren mit Hartmetallschneiden  
 Surgical Scissors with tungsten carbide edges  
 Tijeras para cirugía con filos de carburo tungsteno  
 Forbici per chirurgia con lame in carburo di tungsteno



**MAYO**

14,5 cm, 5 <sup>3</sup> / <sub>4</sub> "	<b>AK-1218-14-TC</b>
17,0 cm, 6 <sup>3</sup> / <sub>4</sub> "	<b>AK-1218-17-TC</b>
23,0 cm, 9"	<b>AK-1218-23-TC</b>



**MAYO**

14,5 cm, 5 <sup>3</sup> / <sub>4</sub> "	<b>AK-1219-14-TC</b>
17,0 cm, 6 <sup>3</sup> / <sub>4</sub> "	<b>AK-1219-17-TC</b>
23,0 cm, 9"	<b>AK-1219-23-TC</b>



**MAYO-STILLE**

15,0 cm, 6"	<b>AK-1220-15-TC</b>
17,0 cm, 6 <sup>3</sup> / <sub>4</sub> "	<b>AK-1220-17-TC</b>



**MAYO-STILLE**

15,0 cm, 6"	<b>AK-1221-15-TC</b>
17,0 cm, 6 <sup>3</sup> / <sub>4</sub> "	<b>AK-1221-17-TC</b>



**LEXER**

16,0 cm, 6 <sup>1</sup> / <sub>4</sub> "	<b>AK-1222-16-TC</b>
21,0 cm, 8 <sup>1</sup> / <sub>4</sub> "	<b>AK-1222-21-TC</b>



**LEXER**

16,0 cm, 6 <sup>1</sup> / <sub>4</sub> "	<b>AK-1223-16-TC</b>
21,0 cm, 8 <sup>1</sup> / <sub>4</sub> "	<b>AK-1223-21-TC</b>



**Präparierscheren mit Hartmetallschneiden**  
**Dissecting Scissors with tungsten carbide edges**  
**Tijeras para disección con filos de carburo tungsteno**  
**Forbici per dissezione con lame in carburo di tungsteno**



**BABY-METZENBAUM**  
 11,5 cm, 4 1/2"

**METZENBAUM**  
 14,5 cm, 5 3/4"

**METZENBAUM**  
 14,5 cm, 5 3/4"



**METZENBAUM**  
 14,5 cm, 5 3/4"

**METZENBAUM**

**METZENBAUM**

- 18,0 cm, 7" **AK-1230-18-TC**
- 20,0 cm, 8" **AK-1230-20-TC**
- 23,0 cm, 9" **AK-1230-23-TC**
- 25,0 cm, 10" **AK-1230-25-TC**
- 28,0 cm, 11" **AK-1230-28-TC**
- 30,0 cm, 12" **AK-1230-30-TC**

- 18,0 cm, 7" **AK-1231-18-TC**
- 20,0 cm, 8" **AK-1231-20-TC**
- 23,0 cm, 9" **AK-1231-23-TC**
- 25,0 cm, 10" **AK-1231-25-TC**
- 28,0 cm, 11" **AK-1231-28-TC**
- 30,0 cm, 12" **AK-1231-30-TC**



18,0 cm, 7" **AK-1234-18-TC**  
 20,0 cm, 8" **AK-1234-20-TC**  
 23,0 cm, 9" **AK-1234-23-TC**  
 25,0 cm, 10" **AK-1234-25-TC**  
 28,0 cm, 11" **AK-1234-28-TC**  
 30,0 cm, 12" **AK-1234-30-TC**

**METZENBAUM**



18,0 cm, 7" **AK-1235-18-TC**  
 20,0 cm, 8" **AK-1235-20-TC**  
 23,0 cm, 9" **AK-1235-23-TC**  
 25,0 cm, 10" **AK-1235-25-TC**  
 28,0 cm, 11" **AK-1235-28-TC**  
 30,0 cm, 12" **AK-1235-30-TC**

**METZENBAUM**

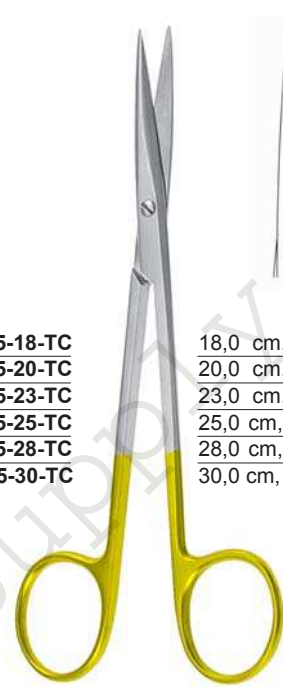

18,0 cm, 7" **AK-1236-18-TC**  
 20,0 cm, 8" **AK-1236-20-TC**  
 23,0 cm, 9" **AK-1236-23-TC**  
 25,0 cm, 10" **AK-1236-25-TC**  
 28,0 cm, 11" **AK-1236-28-TC**  
 30,0 cm, 12" **AK-1236-30-TC**

**METZENBAUM**



18,0 cm, 7" **AK-1237-18-TC**  
 20,0 cm, 8" **AK-1237-20-TC**  
 23,0 cm, 9" **AK-1237-23-TC**  
 25,0 cm, 10" **AK-1237-25-TC**  
 28,0 cm, 11" **AK-1237-28-TC**  
 30,0 cm, 12" **AK-1237-30-TC**

**METZENBAUM**



**AK-1238-14-TC** **AK-1239-14-TC**

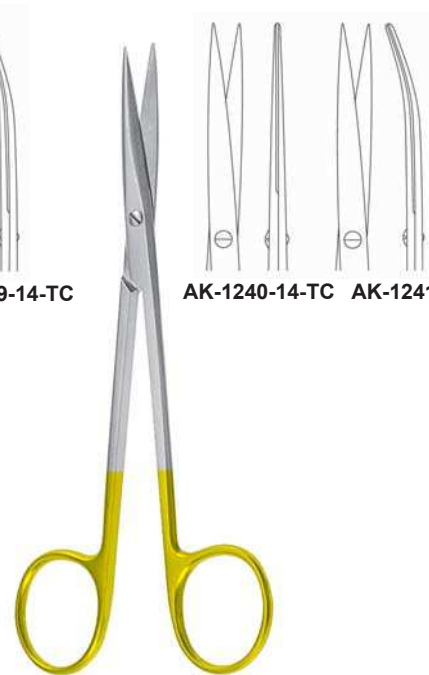

**METZENBAUM-FINO**  
 14,5 cm, 5<sup>3</sup>/<sub>4</sub>"



**AK-1240-14-TC** **AK-1241-14-TC**

**METZENBAUM-FINO**  
 14,5 cm, 5<sup>3</sup>/<sub>4</sub>"

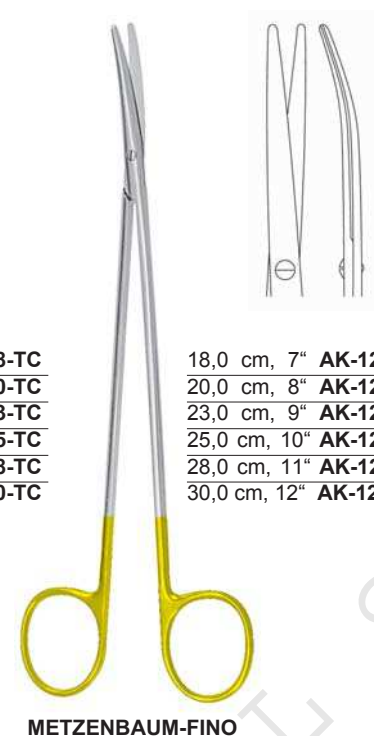
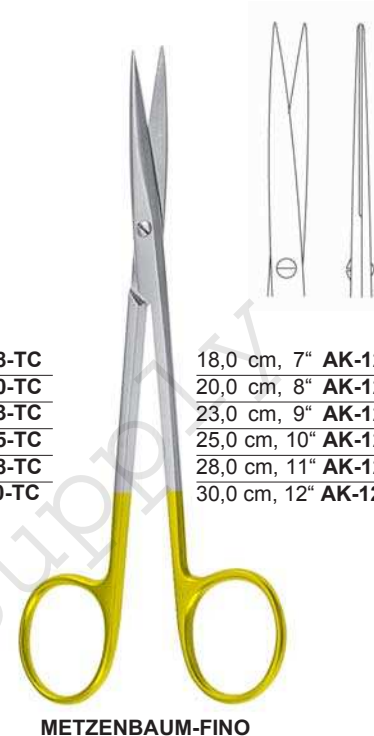
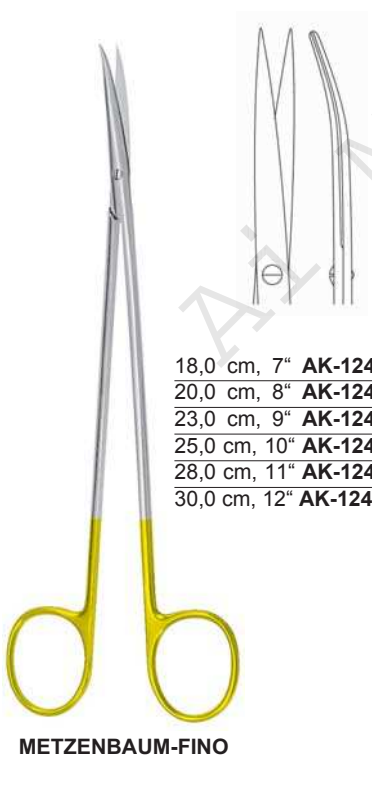
**Präparierscheren mit Hartmetallschneiden**  
**Dissecting Scissors with tungsten carbide edges**  
**Tijeras para disección con filos de carburo tungsteno**  
**Forbici per dissezione con lame in carburo di tungsteno**

 <p>18,0 cm, 7" <b>AK-1242-18-TC</b>          20,0 cm, 8" <b>AK-1242-20-TC</b>          23,0 cm, 9" <b>AK-1242-23-TC</b>          25,0 cm, 10" <b>AK-1242-25-TC</b>          28,0 cm, 11" <b>AK-1242-28-TC</b>          30,0 cm, 12" <b>AK-1242-30-TC</b></p> <p><b>METZENBAUM-FINO</b></p>	 <p>18,0 cm, 7" <b>AK-1243-18-TC</b>          20,0 cm, 8" <b>AK-1243-20-TC</b>          23,0 cm, 9" <b>AK-1243-23-TC</b>          25,0 cm, 10" <b>AK-1243-25-TC</b>          28,0 cm, 11" <b>AK-1243-28-TC</b>          30,0 cm, 12" <b>AK-1243-30-TC</b></p> <p><b>METZENBAUM-FINO</b></p>	 <p>18,0 cm, 7" <b>AK-1244-18-TC</b>          20,0 cm, 8" <b>AK-1244-20-TC</b>          23,0 cm, 9" <b>AK-1244-23-TC</b>          25,0 cm, 10" <b>AK-1244-25-TC</b>          28,0 cm, 11" <b>AK-1244-28-TC</b>          30,0 cm, 12" <b>AK-1244-30-TC</b></p> <p><b>METZENBAUM-FINO</b></p>
 <p>18,0 cm, 7" <b>AK-1245-18-TC</b>          20,0 cm, 8" <b>AK-1245-20-TC</b>          23,0 cm, 9" <b>AK-1245-23-TC</b>          25,0 cm, 10" <b>AK-1245-25-TC</b>          28,0 cm, 11" <b>AK-1245-28-TC</b>          30,0 cm, 12" <b>AK-1245-30-TC</b></p> <p><b>METZENBAUM-FINO</b></p>	 <p><b>METZENBAUM-LAHEY</b>          14,0 cm, 5 1/2"  <b>AK-1246-14-TC</b></p>	 <p><b>TOENNIS-ADSON</b>          17,0 cm, 6 3/4"  <b>AK-1247-17-TC</b></p>

Präparierscheren mit Hartmetallschneiden  
 Dissecting Scissors with tungsten carbide edges  
 Tijeras para disección con filos de carburo tungsteno  
 Forbici per dissezione con lame in carburo di tungsteno

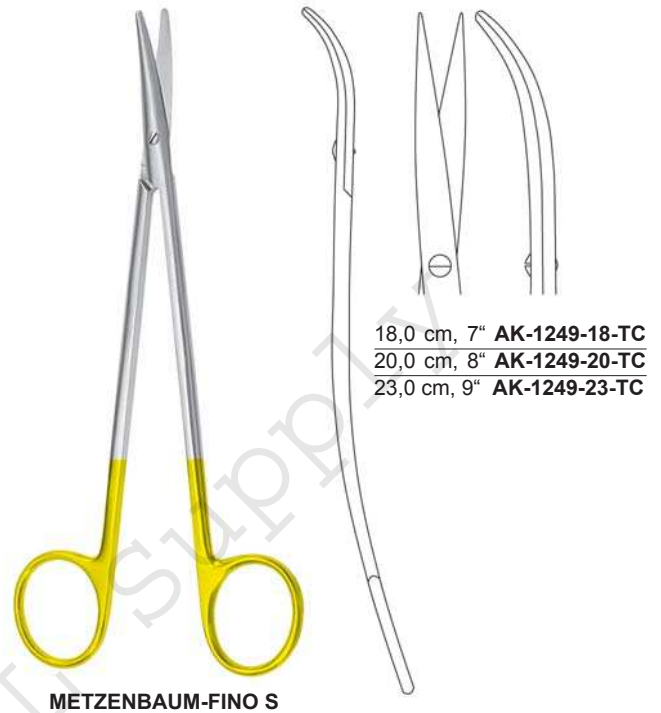
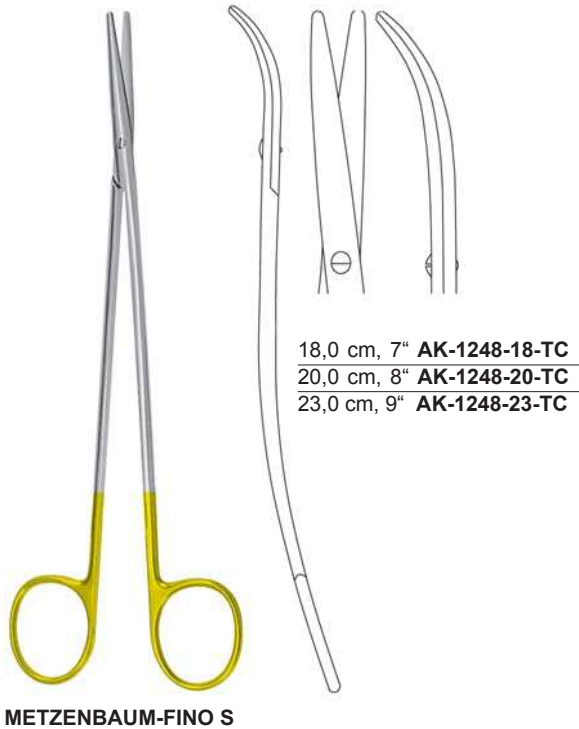

Gynäkologische Scheren mit Hartmetallschneiden  
 Gynecology Scissors with tungsten carbide edges  
 Tijeras para ginecología con filos de carburo tungsteno  
 Forbici per ginecologia con lame in carburo di tungsteno



SIMS



20,0 cm, 8"	AK-1254-20-TC	AK-1255-20-TC	AK-1256-20-TC
23,0 cm, 9"	AK-1254-23-TC	AK-1255-23-TC	AK-1256-23-TC



SIMS



20,0 cm, 8"	AK-1257-20-TC	AK-1258-20-TC	AK-1259-20-TC
23,0 cm, 9"	AK-1257-23-TC	AK-1258-23-TC	AK-1259-23-TC

Gefäßscheren mit Hartmetallschneiden  
 Vascular Scissors with tungsten carbide edges  
 Tijeras vasculares con filos de carburo tungsteno  
 Forbici vascolari con lame in carburo di tungsteno



**DIETRICH**  
 17,5 cm, 6<sup>5</sup>/<sub>8</sub>"  
 AK-1260-17-TC



**POTTS DE MARTEL**  
 24,0 cm, 9<sup>1</sup>/<sub>2</sub>"  
 AK-1261-24-TC



**DE BAKEY**

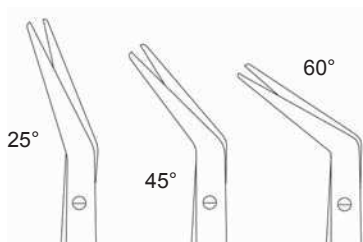

20,0 cm, 8"	<b>AK-1262-25-TC</b>	<b>AK-1264-45-TC</b>	<b>AK-1266-60-TC</b>
23,0 cm, 9"	<b>AK-1263-25-TC</b>	<b>AK-1265-45-TC</b>	<b>AK-1267-60-TC</b>

Gefäßscheren mit Hartmetallschneiden  
 Vascular Scissors with tungsten carbide edges  
 Tijeras vasculares con filos de carburo tungsteno  
 Forbici vascolari con lame in carburo di tungsteno



**DIETHRICH-HEGEMANN**  
 18,0 cm, 7"



**POTTS-SMITH**  
 18,0 cm, 7 1/2"

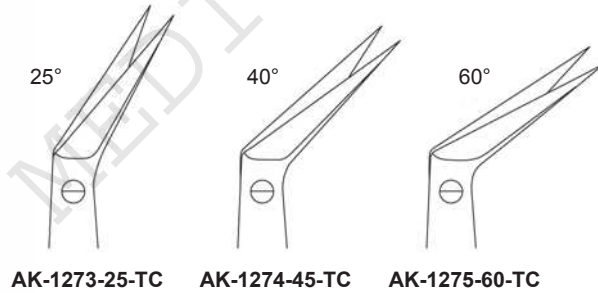

Scheren mit Hartmetallschneiden  
 Scissors with tungsten carbide edges  
 Tijeras con filos de carburo tungsteno  
 Forbici con lame in carburo di tungsteno



AK-1277-11-TC AK-1278-11-TC

**IRIS**  
 11,5 cm, 4 1/2"



gezahnt  
 serrated  
 dentada  
 dentata

**UNIVERSAL**  
 12,0 cm, 4 3/4"  
 AK-1279-12-TC



**LISTER**  
 18,0 cm, 7"  
 AK-1280-18-TC

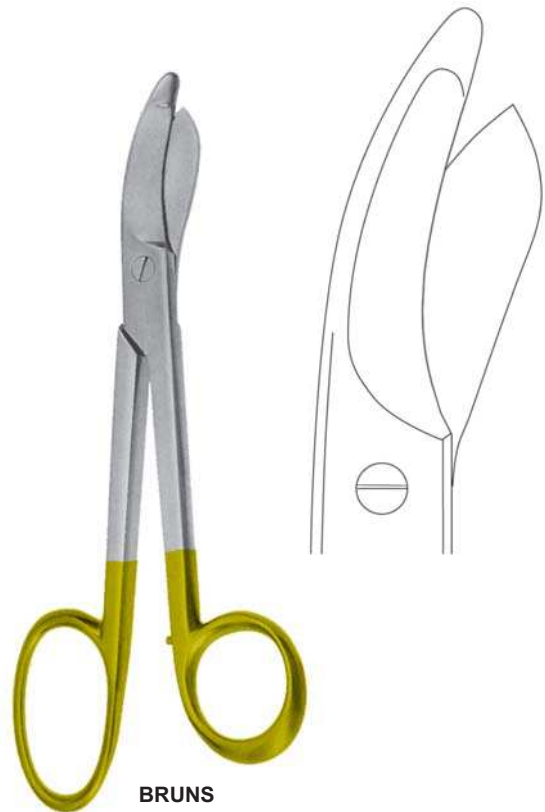

**BRUNS**  
 24,0 cm, 9 1/2"  
 AK-1281-24-TC



Super-Cut Scheren  
 Super-Cut Scissors  
 Tijeras Super-Cut  
 Forbici Super-Cut



**MAYO**  
 17,0 cm, 6<sup>3</sup>/<sub>4</sub>"

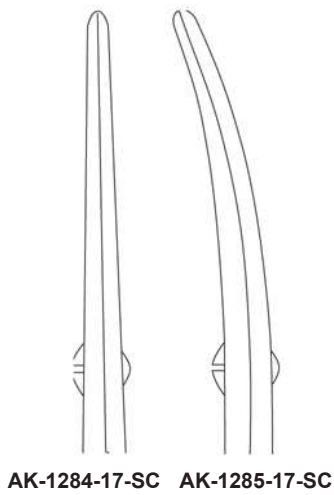

**METZENBAUM**

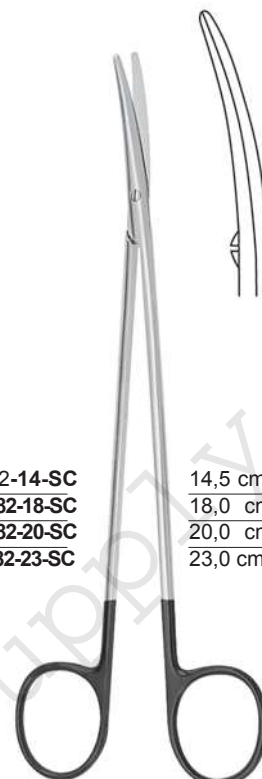
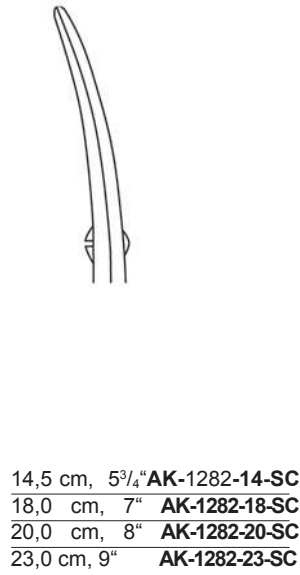

**METZENBAUM-FINO**

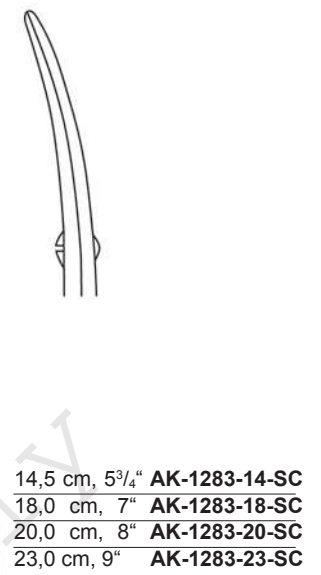

**KAYE FACE LIFT**

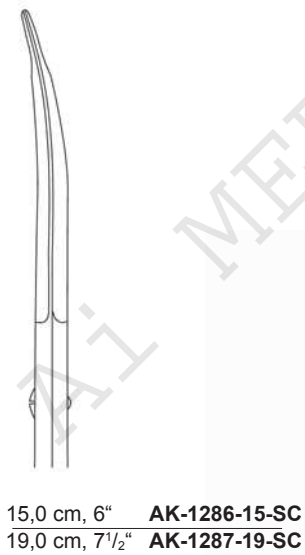

**JABALEY**  
 13,0 cm, 5"  
**AK-1288-13-SC**



**ENDARTERECTOMY**  
 18,0 cm, 7"  
**AK-1289-18-SC**



**TOENNIS-ADSON**  
 17,0 cm, 6<sup>3</sup>/<sub>4</sub>"  
**AK-1290-17-SC**



**STRABISMUS**  
 11,5 cm, 4 $\frac{1}{2}$ "

AK-1291-11-SC

AK-1292-11-SC

**JAMISON**  
 15,0 cm, 6" AK-1293-15-SC  
 18,0 cm, 7" AK-1293-18-SC

**REYNOLDS**  
 12,5 cm, 5" AK-1294-12-SC

**BABY-METZENBAUM**  
 11,0 cm, 4 $\frac{3}{8}$ " AK-1295-11-SC  
 14,5 cm, 5 $\frac{3}{4}$ " AK-1295-14-SC



**IRIS**  
 11,0 cm, 4 $\frac{3}{8}$ "  
 AK-1296-11-SC

**IRIS**  
 11,0 cm, 4 $\frac{3}{8}$ "  
 AK-1297-11-SC

**STEVENS TENOTOMY**  
 11,0 cm, 4 $\frac{3}{8}$ "  
 AK-1298-11-SC

**STEVENS TENOTOMY**  
 11,0 cm, 4 $\frac{3}{8}$ "  
 AK-1299-11-SC

Super-Cut Scheren  
 Super-Cut Scissors  
 Tijeras Super-Cut  
 Forbici Super-Cut



**PAR TYPE**  
 12,0 cm, 4<sup>3</sup>/<sub>4</sub>"  
**AK-1303-12-SC**



**PAR TYPE**  
 12,0 cm, 4<sup>3</sup>/<sub>4</sub>"  
**AK-1304-12-SC**



**POTTS**  
 19,0 cm, 7<sup>1</sup>/<sub>2</sub>"

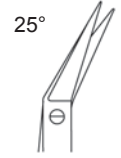

**AK-1300-25-SC**

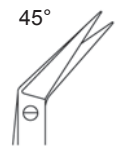

**AK-1301-45-SC**

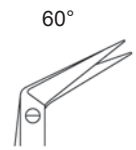

**AK-1302-60-SC**

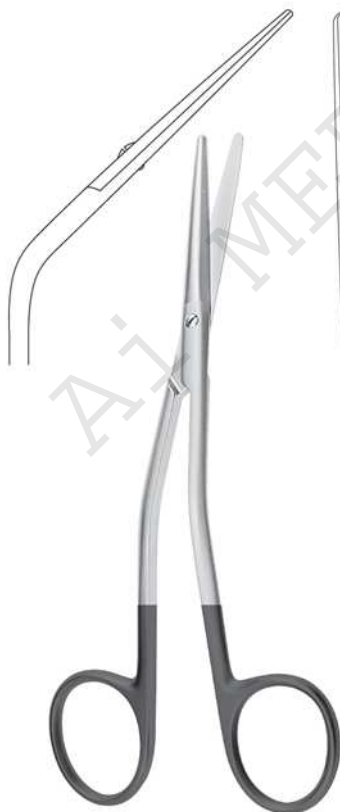

**FOMON**  
 14,5 cm, 5<sup>3</sup>/<sub>4</sub>"  
**AK-1305-15-SC**



**COTTLE**  
 16,5 cm, 6<sup>1</sup>/<sub>2</sub>"  
**AK-1306-16-SC**

**Mikro-Scheren  
Micro Scissors  
Micro-Tijeras  
Micro-Forbici**



**WESTCOTT**  
11,0 cm, 4<sup>3</sup>/<sub>8</sub>"

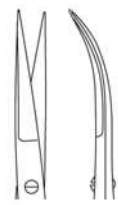

**AK-1307-11-M**

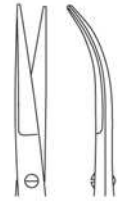

**AK-1308-11-M**



gezahnt  
serrated  
dentada  
dentata

**GOMEL**

14,0 cm, 5<sup>1</sup>/<sub>2</sub>" **AK-1312-14-M**  
16,0 cm, 6<sup>1</sup>/<sub>4</sub>" **AK-1312-16-M**



Mikro-Präparierscheren  
Micro-dissecting scissors  
Micro-tijeras de disección  
Micro-forbici per dissezione

**HEPP SCHEIDEL**

14,0 cm, 5<sup>1</sup>/<sub>2</sub>" **AK-1313-14-M**  
16,0 cm, 6<sup>1</sup>/<sub>4</sub>" **AK-1313-16-M**



**AK-1309-01-M**

**AK-1310-02-M**

**AK-1311-03-M**

18,5 cm, 7<sup>1</sup>/<sub>4</sub>"



**SIMS**



18,5 cm, 7<sup>1</sup>/<sub>4</sub>" **AK-1314-01** **AK-1315-02** **AK-1316-03** **AK-1318-04**  
22,5 cm, 8<sup>3</sup>/<sub>4</sub>" **AK-1319-01** **AK-1320-02** **AK-1321-03** **AK-1322-04**



18,5 cm, 7<sup>1</sup>/<sub>4</sub>" **AK-1323-01-M** **AK-1325-02-M**  
22,5 cm, 8<sup>3</sup>/<sub>4</sub>" **AK-1324-01-M** **AK-1326-02-M**

**Mikro-Scheren, Mikro-Disektionsscheren**  
**Micro Scissors, Micro Dissecting Scissors**  
**Micro-Tijeras, Micro-Tijeras de disección**  
**Micro-Forbici, Micro-Forbici per dissezione**



18,0 cm, 7"

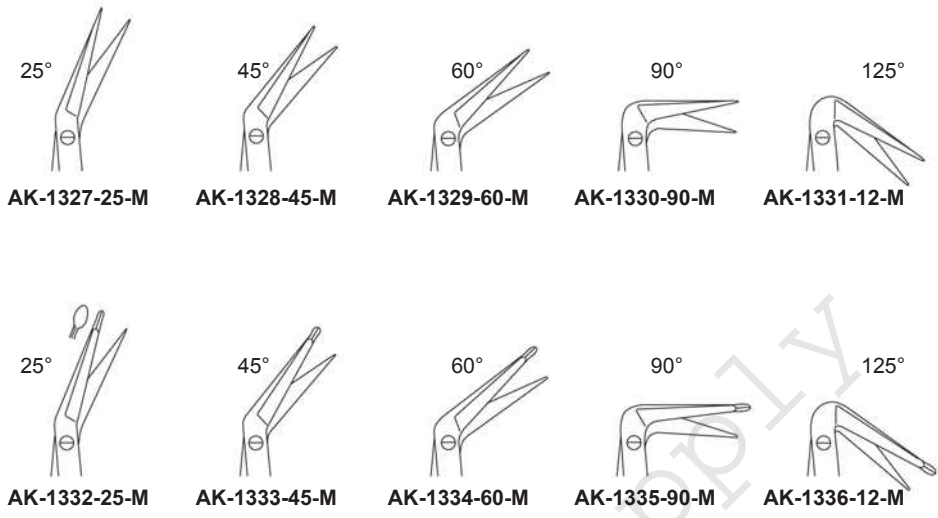

AK-1327-25-M

AK-1328-45-M

AK-1329-60-M

AK-1330-90-M

AK-1331-12-M

AK-1332-25-M

AK-1333-45-M

AK-1334-60-M

AK-1335-90-M

AK-1336-12-M

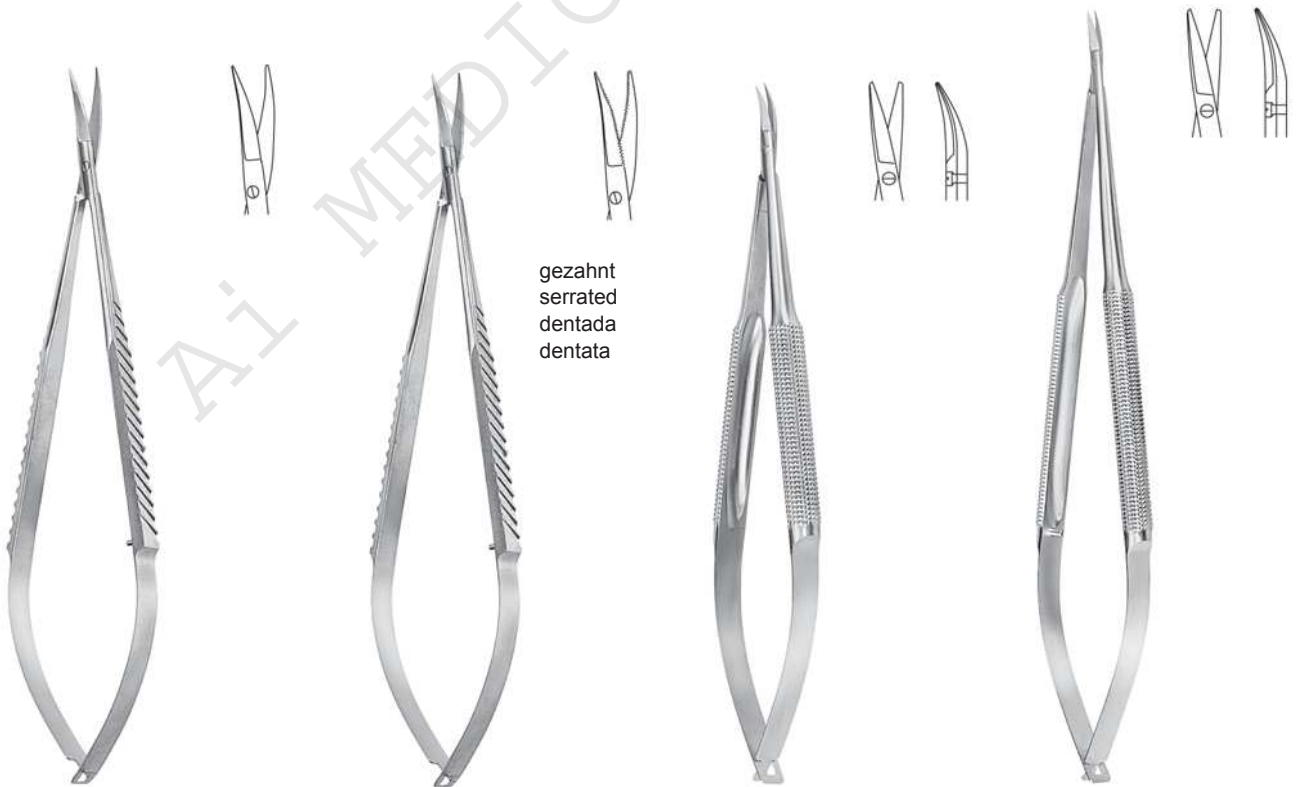

gezahnt  
serrated  
dentada  
dentata

15,0 cm, 6"  
AK-1337-15-M

15,0 cm, 6"  
AK-1338-15-M

15,0 cm, 6"  
AK-1339-15-M

18,0 cm, 7"  
AK-1340-18-M

Mikro-Adventitiascheren  
Micro Adventitia Scissors  
Micro-Tijeras Adventitia  
Micro-Forbici Adventitia



15,0 cm, 6"  
AK-1341-15-M



15,0 cm, 6"  
AK-1342-15-M



gezahnt  
serrated  
dentada  
dentata



15,0 cm, 6"  
AK-1343-15-M



18,0 cm, 7"  
AK-1344-18-M

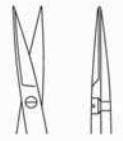

AI MEDICAL SUPPLY

**Pinzetten**  
**Forceps**  
**Pinzas**  
**Pinze**

Ai MEDICAL SUPPLY



Anatomische Pinzetten  
 Dissecting Forceps  
 Pinzas de disección  
 Pinze anatomiche per dissezione



**STANDARD**

10,5 cm, 4 <sup>1</sup> / <sub>8</sub> "	<b>AK-1345-10</b>
11,5 cm, 4 <sup>1</sup> / <sub>2</sub> "	<b>AK-1345-11</b>
13,0 cm, 5"	<b>AK-1345-13</b>
14,5 cm, 5 <sup>3</sup> / <sub>4</sub> "	<b>AK-1345-14</b>
15,0 cm, 6"	<b>AK-1345-15</b>
16,0 cm, 6 <sup>1</sup> / <sub>4</sub> "	<b>AK-1345-16</b>
18,0 cm, 7"	<b>AK-1345-18</b>
20,0 cm, 8"	<b>AK-1345-20</b>
25,0 cm, 10"	<b>AK-1345-25</b>
30,0 cm, 12"	<b>AK-1345-30</b>



schmal  
 narrow  
 estrechos  
 stretti

**STANDARD**

10,5 cm, 4 <sup>1</sup> / <sub>8</sub> "	<b>AK-1346-10</b>
11,5 cm, 4 <sup>1</sup> / <sub>2</sub> "	<b>AK-1346-11</b>
13,0 cm, 5"	<b>AK-1346-13</b>
14,5 cm, 5 <sup>3</sup> / <sub>4</sub> "	<b>AK-1346-14</b>
15,0 cm, 6"	<b>AK-1346-15</b>
16,0 cm, 6 <sup>1</sup> / <sub>4</sub> "	<b>AK-1346-16</b>
18,0 cm, 7"	<b>AK-1346-18</b>
20,0 cm, 8"	<b>AK-1346-20</b>
25,0 cm, 10"	<b>AK-1346-25</b>
30,0 cm, 12"	<b>AK-1346-30</b>



schmal  
 narrow  
 estrechos  
 stretti

**STANDARD**

10,5 cm, 4 <sup>1</sup> / <sub>8</sub> "	<b>AK-1347-10</b>
11,5 cm, 4 <sup>1</sup> / <sub>2</sub> "	<b>AK-1347-11</b>
13,0 cm, 5"	<b>AK-1347-13</b>
14,5 cm, 5 <sup>3</sup> / <sub>4</sub> "	<b>AK-1347-14</b>
15,0 cm, 6"	<b>AK-1347-15</b>
16,0 cm, 6 <sup>1</sup> / <sub>4</sub> "	<b>AK-1347-16</b>
18,0 cm, 7"	<b>AK-1347-18</b>
20,0 cm, 8"	<b>AK-1347-20</b>
25,0 cm, 10"	<b>AK-1347-25</b>
30,0 cm, 12"	<b>AK-1347-30</b>



fein  
 fine  
 finas  
 fini

**STANDARD**

10,5 cm, 4 <sup>1</sup> / <sub>8</sub> "	<b>AK-1348-10</b>
11,5 cm, 4 <sup>1</sup> / <sub>2</sub> "	<b>AK-1348-11</b>
13,0 cm, 5"	<b>AK-1348-13</b>
14,5 cm, 5 <sup>3</sup> / <sub>4</sub> "	<b>AK-1348-14</b>
15,0 cm, 6"	<b>AK-1348-15</b>
16,0 cm, 6 <sup>1</sup> / <sub>4</sub> "	<b>AK-1348-16</b>
18,0 cm, 7"	<b>AK-1348-18</b>
20,0 cm, 8"	<b>AK-1348-20</b>
25,0 cm, 10"	<b>AK-1348-25</b>
30,0 cm, 12"	<b>AK-1348-30</b>



Anatomische Pinzetten  
 Dissecting Forceps  
 Pinzas de disección  
 Pinze anatomiche per dissezione



fein  
 fine  
 finas  
 fini



fein  
 fine  
 finas  
 fini

mit Stift  
 with pin  
 con perno  
 con espiga



MOD. USA

12,0 cm, 4 <sup>3</sup> / <sub>4</sub> "	<b>AK-1351-10</b>
13,0 cm, 5"	<b>AK-1351-13</b>
14,5 cm, 5 <sup>3</sup> / <sub>4</sub> "	<b>AK-1351-14</b>
15,0 cm, 6"	<b>AK-1351-15</b>
18,0 cm, 7"	<b>AK-1351-18</b>
20,0 cm, 8"	<b>AK-1351-20</b>
25,5 cm, 10"	<b>AK-1351-25</b>
30,0 cm, 12"	<b>AK-1351-30</b>



schmal  
 narrow  
 estrechos  
 stretti

MOD. USA

12,0 cm, 4 <sup>3</sup> / <sub>4</sub> "	<b>AK-1352-11</b>
13,0 cm, 5"	<b>AK-1352-13</b>
14,5 cm, 5 <sup>3</sup> / <sub>4</sub> "	<b>AK-1352-14</b>
15,0 cm, 6"	<b>AK-1352-15</b>
18,0 cm, 7"	<b>AK-1352-18</b>
20,0 cm, 8"	<b>AK-1352-20</b>
25,5 cm, 10"	<b>AK-1352-25</b>

10,5 cm, 4 <sup>1</sup> / <sub>8</sub> "	<b>AK-1349-10</b>
11,5 cm, 4 <sup>1</sup> / <sub>2</sub> "	<b>AK-1349-11</b>
13,0 cm, 5"	<b>AK-1349-13</b>
14,5 cm, 5 <sup>3</sup> / <sub>4</sub> "	<b>AK-1349-14</b>
16,0 cm, 6 <sup>1</sup> / <sub>4</sub> "	<b>AK-1349-16</b>
18,0 cm, 7"	<b>AK-1349-18</b>
20,0 cm, 8"	<b>AK-1349-20</b>
25,0 cm, 10"	<b>AK-1349-25</b>
30,0 cm, 12"	<b>AK-1349-30</b>

10,5 cm, 4 <sup>1</sup> / <sub>8</sub> "	<b>AK-1350-10</b>
11,5 cm, 4 <sup>1</sup> / <sub>2</sub> "	<b>AK-1350-11</b>
13,0 cm, 5"	<b>AK-1350-13</b>
14,5 cm, 5 <sup>3</sup> / <sub>4</sub> "	<b>AK-1350-14</b>
16,0 cm, 6 <sup>1</sup> / <sub>4</sub> "	<b>AK-1350-16</b>
18,0 cm, 7"	<b>AK-1350-18</b>
20,0 cm, 8"	<b>AK-1350-20</b>
25,0 cm, 10"	<b>AK-1350-25</b>
30,0 cm, 12"	<b>AK-1350-30</b>

Anatomische Pinzetten  
 Dissecting Forceps  
 Pinzas de disección  
 Pinze anatomiche per dissezione



**ADSON**

12,0 cm, 4<sup>3</sup>/<sub>4</sub>" **AK-1353-12**  
 15,0 cm, 6" **AK-1353-15**



**MICRO-ADSON**

12,0 cm, 4<sup>3</sup>/<sub>4</sub>" **AK-1354-12**  
 15,0 cm, 6" **AK-1354-15**



**STILLE**

15,0 cm, 6"  
**AK-1355-15**



**MC INDOE**

15,0 cm, 6"  
**AK-1356-15**



**TAYLOR**

17,5 cm, 6<sup>5</sup>/<sub>8</sub>"  
**AK-1357-17**



**TAYLOR**

17,5 cm, 6<sup>5</sup>/<sub>8</sub>"  
**AK-1358-17**



**TAYLOR**

18,5 cm, 7<sup>1</sup>/<sub>4</sub>"  
**AK-1359-18**



**GERALD**

18,0 cm, 7"  
**AK-1360-18**

Anatomische Pinzetten  
 Dissecting Forceps  
 Pinzas de disección  
 Pinze anatomiche per dissezione



**GERALD**  
 18,0 cm, 7"  
 AK-1361-18



**POTTS-SMITH**  
 18,0 cm, 7" **AK-1362-18**  
 21,0 cm, 8<sup>1</sup>/<sub>4</sub>" **AK-1362-21**  
 25,0 cm, 10" **AK-1362-25**



**POTTS-SMITH**  
 18,0 cm, 7" **AK-1363-18**  
 21,0 cm, 8<sup>1</sup>/<sub>4</sub>" **AK-1363-21**  
 25,0 cm, 10" **AK-1363-25**



englische Modelle  
 english patterns  
 modelos ingleses  
 modelli inglese

13,0 cm, 5" **AK-1364-13**  
 14,5 cm, 5<sup>3</sup>/<sub>4</sub>" **AK-1364-14**  
 15,0 cm, 6" **AK-1364-15**



**SEMKEN**  
 12,5 cm, 5" **AK-1365-12**  
 15,0 cm, 6" **AK-1365-15**



**CUSHING**  
 17,5 cm, 6<sup>5</sup>/<sub>8</sub>"  
**AK-1366-17**



**CUSHING**  
 17,5 cm, 6<sup>5</sup>/<sub>8</sub>"  
**AK-1367-17**



**BROPHY**  
 20,0 cm, 8"  
**AK-1368-20**

Anatomische Pinzetten  
 Dissecting Forceps  
 Pinzas de disección  
 Pinze anatomiche per dissezione



**BROPHY**  
 20,0 cm, 8"  
 AK-1369-20



**BONNEY**  
 18,0 cm, 7"  
 AK-1370-18



**SINGLE-TUTTLE**  
 23,0 cm, 9"  
 AK-1371-23

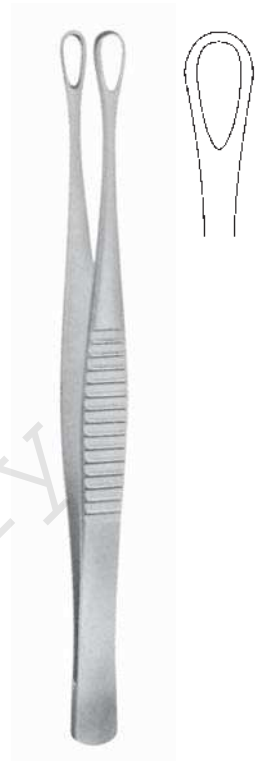

**DENNIS BROWN**  
 20,0 cm, 8"  
 AK-1372-20



**DUEHRSEN**  
 20,0 cm, 8"  
 AK-1373-20



**WAUGH**  
 15,0 cm, 6"    **AK-1374-15**  
 20,0 cm, 8"    **AK-1374-20**



**RAMSEY**  
 18,0 cm, 7"  
 AK-1375-18



**STANDARD**

10,5 cm, 4 <sup>1</sup> / <sub>8</sub> "	<b>AK-1376-10</b>
11,5 cm, 4 <sup>1</sup> / <sub>2</sub> "	<b>AK-1376-11</b>
13,0 cm, 5"	<b>AK-1376-13</b>
14,5 cm, 5 <sup>3</sup> / <sub>4</sub> "	<b>AK-1376-14</b>
15,0 cm, 6"	<b>AK-1376-15</b>
16,0 cm, 6 <sup>1</sup> / <sub>4</sub> "	<b>AK-1376-16</b>
18,0 cm, 7"	<b>AK-1376-18</b>
20,0 cm, 8"	<b>AK-1376-20</b>
25,0 cm, 10"	<b>AK-1376-25</b>
30,0 cm, 12"	<b>AK-1376-30</b>

11,5 cm, 4 <sup>1</sup> / <sub>2</sub> "	<b>AK-1377-11</b>
13,0 cm, 5"	<b>AK-1377-13</b>
14,5 cm, 5 <sup>3</sup> / <sub>4</sub> "	<b>AK-1377-14</b>
16,0 cm, 6 <sup>1</sup> / <sub>4</sub> "	<b>AK-1377-16</b>
18,0 cm, 7"	<b>AK-1377-18</b>
20,0 cm, 8"	<b>AK-1377-20</b>
25,0 cm, 10"	<b>AK-1377-25</b>
30,0 cm, 12"	<b>AK-1377-30</b>

13,0 cm, 5"	<b>AK-1378-13</b>
14,5 cm, 5 <sup>3</sup> / <sub>4</sub> "	<b>AK-1378-14</b>
16,0 cm, 6 <sup>1</sup> / <sub>4</sub> "	<b>AK-1378-16</b>
18,0 cm, 7"	<b>AK-1378-18</b>
20,0 cm, 8"	<b>AK-1378-20</b>

13,0 cm, 5"	<b>AK-1379-13</b>
14,5 cm, 5 <sup>3</sup> / <sub>4</sub> "	<b>AK-1379-14</b>
16,0 cm, 6 <sup>1</sup> / <sub>4</sub> "	<b>AK-1379-16</b>
18,0 cm, 7"	<b>AK-1379-18</b>
20,0 cm, 8"	<b>AK-1379-20</b>

Chirurgische Pinzetten  
 Tissue Forceps  
 Pinzas quirúrgicas  
 Pinze per chirurgia



13,0 cm, 5"	<b>AK-1380-13</b>
14,5 cm, 5 <sup>3</sup> / <sub>4</sub> "	<b>AK-1380-14</b>
15,5 cm, 6"	<b>AK-1380-15</b>
16,0 cm, 6 <sup>1</sup> / <sub>4</sub> "	<b>AK-1380-16</b>
18,0 cm, 7"	<b>AK-1380-18</b>
20,0 cm, 8"	<b>AK-1380-20</b>
25,0 cm, 10"	<b>AK-1380-25</b>
30,0 cm, 12"	<b>AK-1380-30</b>



13,0 cm, 5"	<b>AK-1381-13</b>
14,5 cm, 5 <sup>3</sup> / <sub>4</sub> "	<b>AK-1381-14</b>
15,5 cm, 6"	<b>AK-1381-15</b>
16,0 cm, 6 <sup>1</sup> / <sub>4</sub> "	<b>AK-1381-16</b>
18,0 cm, 7"	<b>AK-1381-18</b>
20,0 cm, 8"	<b>AK-1381-20</b>
25,0 cm, 10"	<b>AK-1381-25</b>
30,0 cm, 12"	<b>AK-1381-30</b>



13,0 cm, 5"	<b>AK-1382-13</b>
14,5 cm, 5 <sup>3</sup> / <sub>4</sub> "	<b>AK-1382-14</b>
16,0 cm, 6 <sup>1</sup> / <sub>4</sub> "	<b>AK-1382-16</b>
18,0 cm, 7"	<b>AK-1382-18</b>
20,0 cm, 8"	<b>AK-1382-20</b>



13,0 cm, 5"	<b>AK-1383-13</b>
14,5 cm, 5 <sup>3</sup> / <sub>4</sub> "	<b>AK-1383-14</b>
15,0 cm, 6"	<b>AK-1383-15</b>



**MOD. USA**

12,0 cm, 4 <sup>3</sup> / <sub>4</sub> "	<b>AK-1384-12</b>
13,0 cm, 5"	<b>AK-1384-13</b>
14,5 cm, 5 <sup>3</sup> / <sub>4</sub> "	<b>AK-1384-14</b>
15,5 cm, 6"	<b>AK-1384-15</b>
18,0 cm, 7"	<b>AK-1384-18</b>
20,0 cm, 8"	<b>AK-1384-20</b>
25,0 cm, 10"	<b>AK-1384-25</b>
30,0 cm, 12"	<b>AK-1384-30</b>

**MOD. USA**

12,0 cm, 4 <sup>3</sup> / <sub>4</sub> "	<b>AK-1385-12</b>
13,0 cm, 5"	<b>AK-1385-13</b>
14,5 cm, 5 <sup>3</sup> / <sub>4</sub> "	<b>AK-1385-14</b>
15,5 cm, 6"	<b>AK-1385-15</b>
18,0 cm, 7"	<b>AK-1385-18</b>
20,0 cm, 8"	<b>AK-1385-20</b>
25,0 cm, 10"	<b>AK-1385-25</b>
30,0 cm, 12"	<b>AK-1385-30</b>

**ADSON**

12,0 cm, 4 <sup>3</sup> / <sub>4</sub> "	<b>AK-1386-12</b>
15,0 cm, 6"	<b>AK-1386-15</b>

**MICRO-ADSON**

12,0 cm, 4 <sup>3</sup> / <sub>4</sub> "	<b>AK-1387-12</b>
15,0 cm, 6"	<b>AK-1387-15</b>

Chirurgische Pinzetten  
 Tissue Forceps  
 Pinzas quirúrgicas  
 Pinze per chirurgia



**ADSON**  
 12,0 cm, 4<sup>3</sup>/<sub>4</sub>" **AK-1388-12**  
 15,0 cm, 6" **AK-1388-15**



**ADSON-BROWN**  
 12,0 cm, 4<sup>3</sup>/<sub>4</sub>" **AK-1389-12**  
 15,0 cm, 6" **AK-1389-15**



**ADSON**  
 12,0 cm, 4<sup>3</sup>/<sub>4</sub>" **AK-1390-12**



**STILLE**  
 15,0 cm, 6" **AK-1391-15**



**STILLE**  
 15,0 cm, 6" **AK-1392-15**



**GILLIES**  
 15,0 cm, 6" **AK-1393-15**



**ADLERKREUTZ**  
 15,0 cm, 6" **AK-1394-15**  
 20,0 cm, 8" **AK-1394-20**



**ADLERKREUTZ**  
 15,0 cm, 6" **AK-1395-15**  
 20,0 cm, 8" **AK-1395-20**



Chirurgische Pinzetten  
Tissue Forceps  
Pinzas quirúrgicas  
Pinze per chirurgia



**SEMKEN**  
12,5 cm, 5" **AK-1396-12**  
15,5 cm, 6" **AK-1396-15**



**SEMKEN**  
12,5 cm, 5" **AK-1397-12**



**MC INDOE**  
15,0 cm, 6" **AK-1398-15**



**TAYLOR**  
17,5 cm, 6<sup>5</sup>/<sub>8</sub>" **AK-1399-17**



**TAYLOR**  
17,5 cm, 6<sup>5</sup>/<sub>8</sub>" **AK-1400-17**



**TAYLOR**  
17,5 cm, 6<sup>5</sup>/<sub>8</sub>" **AK-1401-17**



**GERALD**  
18,0 cm, 7" **AK-1402-18**



**GERALD**  
18,0 cm, 7" **AK-1403-18**

Chirurgische Pinzetten  
Tissue Forceps  
Pinzas quirúrgicas  
Pinze per chirurgia



**CUSHING**  
17,5 cm, 6<sup>5</sup>/<sub>8</sub>"  
AK-1404-17



**CUSHING**  
17,5 cm, 6<sup>5</sup>/<sub>8</sub>"  
AK-1405-17



**POTTS-SMITH**  
18,0 cm, 7" **AK-1406-18**  
21,0 cm, 8<sup>1</sup>/<sub>4</sub>" **AK-1406-21**  
25,0 cm, 10" **AK-1406-25**



**POTTS-SMITH**  
18,0 cm, 7" **AK-1407-18**  
21,0 cm, 8<sup>1</sup>/<sub>4</sub>" **AK-1407-21**  
25,0 cm, 10" **AK-1407-25**



**WAUGH**  
15,0 cm, 6" **AK-1408-15**  
20,0 cm, 8" **AK-1408-20**



**BROPHY**  
20,0 cm, 8"  
AK-1409-20



**BROPHY**  
20,0 cm, 8"  
AK-1410-20



**RUSS. MODELL**  
15,0 cm, 6" **AK-1411-15**  
20,0 cm, 8" **AK-1411-20**  
25,0 cm, 10" **AK-1411-25**

Chirurgische Pinzetten  
Tissue Forceps  
Pinzas quirúrgicas  
Pinze per chirurgia



**DURANTE**

14,5 cm, 5<sup>3</sup>/<sub>4</sub>" **AK-1413-14**  
16,0 cm, 6<sup>1</sup>/<sub>4</sub>" **AK-1413-16**  
20,0 cm, 8" **AK-1413-20**



**DUEHRSEN**

20,0 cm, 8"

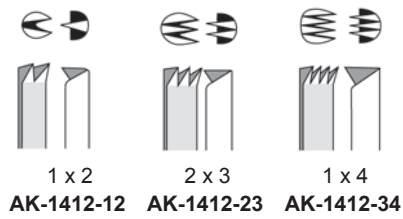

**NELSON**

15,0 cm, 6" **AK-1414-15**  
20,0 cm, 8" **AK-1414-20**  
23,0 cm, 9" **AK-1414-23**



**DUVAL**  
14,0 cm, 5<sup>1</sup>/<sub>2</sub>"



Fig. 1

**AK-1415-14**



Fig. 2

**AK-1416-14**



**COLLIN-DUVAL**  
20,0 cm, 8"



Fig. 1

**AK-1417-01**

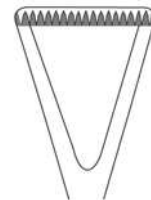

Fig. 2

**AK-1418-02**

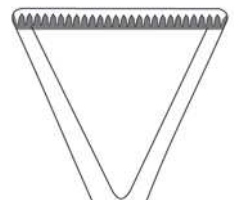

Fig. 3

**AK-1419-03**

Chirurgische Pinzetten  
 Tissue Forceps  
 Pinzas quirúrgicas  
 Pinze per chirurgia



**LANE**  
 14,5 cm, 5<sup>3</sup>/<sub>4</sub>" **AK-1420-14**  
 20,0 cm, 8" **AK-1420-20**



**LANE**  
 14,5 cm, 5<sup>3</sup>/<sub>4</sub>" **AK-1421-14**  
 20,0 cm, 8" **AK-1421-20**



**BROWN**  
 15,0 cm, 6" **AK-1422-15**  
 20,0 cm, 8" **AK-1422-20**  
 25,0 cm, 10" **AK-1422-25**



**TREVES**  
 13,0 cm, 5" **AK-1423-13**  
 15,0 cm, 6" **AK-1423-15**



**RAMSEY**  
 18,0 cm, 7" **AK-1424-18**



**RAMSEY**  
 18,0 cm, 7" **AK-1425-18**



**RAMSEY**  
 18,0 cm, 7" **AK-1426-18**



**RAMSEY**  
 18,0 cm, 7" **AK-1427-18**

**Splitterpinzetten  
Splinter Forceps  
Pinzas para espinas  
Pinze per schegge**

1 x 2

**gerieft**



**gebogen  
gerieft**



**mit Stift**



**mit Stift  
gebogen  
gerieft**



8,0 cm, 3 <sup>1</sup> / <sub>4</sub> "	<b>AK-1428-08</b>
9,0 cm, 3 <sup>1</sup> / <sub>2</sub> "	<b>AK-1428-09</b>
10,5 cm, 4 <sup>1</sup> / <sub>8</sub> "	<b>AK-1428-10</b>
11,5 cm, 4 <sup>1</sup> / <sub>2</sub> "	<b>AK-1428-11</b>
13,0 cm, 5"	<b>AK-1428-13</b>
14,5 cm, 5 <sup>1</sup> / <sub>2</sub> "	<b>AK-1428-14</b>

8,0 cm, 3 <sup>1</sup> / <sub>4</sub> "	<b>AK-1429-08</b>
9,0 cm, 3 <sup>1</sup> / <sub>2</sub> "	<b>AK-1429-09</b>
10,5 cm, 4 <sup>1</sup> / <sub>8</sub> "	<b>AK-1429-10</b>
11,5 cm, 4 <sup>1</sup> / <sub>2</sub> "	<b>AK-1429-11</b>
13,0 cm, 5"	<b>AK-1429-13</b>
14,5 cm, 5 <sup>1</sup> / <sub>2</sub> "	<b>AK-1429-14</b>

8,0 cm, 3 <sup>1</sup> / <sub>4</sub> "	<b>AK-1430-08</b>
9,0 cm, 3 <sup>1</sup> / <sub>2</sub> "	<b>AK-1430-09</b>
10,5 cm, 4 <sup>1</sup> / <sub>8</sub> "	<b>AK-1430-10</b>
11,5 cm, 4 <sup>1</sup> / <sub>2</sub> "	<b>AK-1430-11</b>
13,0 cm, 5"	<b>AK-1430-13</b>
14,5 cm, 5 <sup>1</sup> / <sub>2</sub> "	<b>AK-1430-14</b>

8,0 cm, 3 <sup>1</sup> / <sub>4</sub> "	<b>AK-1431-08</b>
9,0 cm, 3 <sup>1</sup> / <sub>2</sub> "	<b>AK-1431-09</b>
10,5 cm, 4 <sup>1</sup> / <sub>8</sub> "	<b>AK-1431-10</b>
11,5 cm, 4 <sup>1</sup> / <sub>2</sub> "	<b>AK-1431-11</b>
13,0 cm, 5"	<b>AK-1431-13</b>
14,5 cm, 5 <sup>1</sup> / <sub>2</sub> "	<b>AK-1431-14</b>

Splitterpinzetten, Mikro-Pinzetten  
 Splinter Forceps, Micro Forceps  
 Pinzas para espinas, Pinzas para microscopia  
 Pinze per schegge, Pinze per microscopia



**HUNTER**  
 10,5 cm, 4<sup>1</sup>/<sub>4</sub>"  
 AK-1432-10



**HUNTER**  
 10,5 cm, 4<sup>1</sup>/<sub>4</sub>"  
 AK-1433-10



**WALTER-CARMALT**  
 10,5 cm, 4<sup>1</sup>/<sub>4</sub>"  
 AK-1434-10



**WALTER-CARMALT**  
 10,5 cm, 4<sup>1</sup>/<sub>4</sub>"  
 AK-1435-10



**FEILCHENFELD**  
 7,5 cm, 3<sup>1</sup>/<sub>8</sub>" **AK-1436-07**  
 9,0 cm, 3<sup>1</sup>/<sub>2</sub>" **AK-1436-09**  
 11,5 cm, 4<sup>1</sup>/<sub>2</sub>" **AK-1436-11**



10,0 cm, 4"  
 AK-1437-10



10,0 cm, 4"  
 AK-1438-10



10,0 cm, 4"  
**AK-1439-10**  
 selbsthaltend  
 glatt

Mikro-Pinzetten  
Micro Forceps  
Pinzas para microscopia  
Pinze per microscopia



**GRAEFE**  
10,0 cm, 4"  
AK-1440-10



**GRAEFE**  
10,0 cm, 4"  
AK-1441-10



**GRAEFE**  
10,0 cm, 4"  
AK-1442-10



**GRAEFE**  
10,0 cm, 4"  
AK-1443-10



**GRAEFE**  
10,0 cm, 4"  
AK-1444-10



**GRAEFE**  
10,0 cm, 4"  
AK-1445-10

Uhrmacher Pinzetten, Gefäßdilatoren  
 Jeweller's Forceps, Vessel Dilators  
 Pinzas de relojería, Dilatadores vasculares  
 Pinze per orologiaio, Dilatatori vascolari



Fig. 3  
 11,5 cm, 4 1/2"  
 AK-1446-03



Fig. 4  
 11,5 cm, 4 1/2"  
 AK-1447-04



Fig. 5  
 11,5 cm, 4 1/2"  
 AK-1448-05



Fig. 7  
 11,5 cm, 4 1/2"  
 AK-1449-07

0,3 mm x 45°



11,0 cm, 4 3/8"  
 AK-1450-01

0,3 mm x 90°



11,0 cm, 4 3/8"  
 AK-1451-02

0,3 mm



11,0 cm, 4 3/8"  
 AK-1452-03

0,3 mm x 45°



11,0 cm, 4 3/8"  
 AK-1453-04

diamantbeschichtet  
 diamond coated  
 diamantato  
 diamantato



Gefäßdilatoren, Atraumatische Pinzetten  
 Vessel Dilators, Atraumatic Forceps  
 Dilatadores vasculares, Pinzas atraumáticas  
 Dilatatori vascolari, Pinze anatomiche atraumatica

0,3 mm



9 mm

12,0 cm, 4<sup>3</sup>/<sub>4</sub>"  
**AK-1454-12**

0,3 mm



9 mm

13,5 cm, 5<sup>3</sup>/<sub>8</sub>"  
**AK-1455-13**

0,4 mm



9 mm

13,5 cm, 5<sup>3</sup>/<sub>8</sub>"  
**AK-1456-13**

0,3 mm x 45°



9 mm

13,5 cm, 5<sup>3</sup>/<sub>8</sub>"  
**AK-1457-13**



1,5 mm    2,0 mm    2,4 mm    2,8 mm

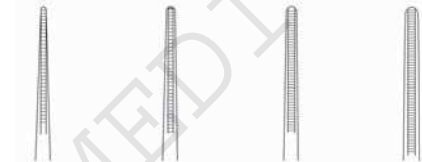

16,0 cm, 6 <sup>1</sup> / <sub>4</sub> "	<b>AK-1458-16</b>	<b>AK-1459-16</b>	<b>AK-1460-16</b>	<b>AK-1461-16</b>
20,0 cm, 8"	<b>AK-1458-20</b>	<b>AK-1459-20</b>	<b>AK-1460-20</b>	<b>AK-1461-20</b>
24,0 cm, 9 <sup>1</sup> / <sub>2</sub> "	<b>AK-1458-24</b>	<b>AK-1459-24</b>	<b>AK-1460-24</b>	<b>AK-1461-24</b>
30,0 cm, 12"	<b>AK-1458-30</b>	<b>AK-1459-30</b>	<b>AK-1460-30</b>	<b>AK-1461-30</b>

2,8 mm    3,5 mm    3,5 mm



16,0 cm, 6 <sup>1</sup> / <sub>4</sub> "	<b>AK-1462-16</b>	<b>AK-1463-16</b>	<b>AK-1464-16</b>
20,0 cm, 8"	<b>AK-1462-20</b>	<b>AK-1463-20</b>	<b>AK-1464-20</b>
24,0 cm, 9 <sup>1</sup> / <sub>2</sub> "	<b>AK-1462-24</b>	<b>AK-1463-24</b>	<b>AK-1464-24</b>
30,0 cm, 12"	<b>AK-1462-30</b>	<b>AK-1463-30</b>	<b>AK-1464-30</b>



1,5 mm    2,0 mm



16,0 cm, 6 <sup>1</sup> / <sub>4</sub> "	<b>AK-1465-16</b>	<b>AK-1466-16</b>
20,0 cm, 8"	<b>AK-1465-20</b>	<b>AK-1466-20</b>
24,0 cm, 9 <sup>1</sup> / <sub>2</sub> "	<b>AK-1465-24</b>	<b>AK-1466-24</b>
30,0 cm, 12"	<b>AK-1465-30</b>	<b>AK-1466-30</b>

DE BAKEY

DE BAKEY

Pinzetten mit Hartmetalleinlagen  
 Forceps with tungsten carbide inserts  
 Pinzas con bocas de carburo tungsteno  
 Pinze con morsi in carburo di tungsteno



STANDARD	
14,5 cm, 5 <sup>3</sup> / <sub>4</sub> "	<b>AK-1467-14</b>
16,0 cm, 6 <sup>1</sup> / <sub>4</sub> "	<b>AK-1467-16</b>
18,0 cm, 7"	<b>AK-1467-18</b>
20,0 cm, 8"	<b>AK-1467-20</b>
25,0 cm, 10"	<b>AK-1467-25</b>
30,0 cm, 12"	<b>AK-1467-30</b>

STANDARD	
14,0 cm, 5 <sup>1</sup> / <sub>2</sub> "	<b>AK-1468-14</b>
16,0 cm, 6 <sup>1</sup> / <sub>4</sub> "	<b>AK-1468-16</b>
18,0 cm, 7"	<b>AK-1468-18</b>
20,0 cm, 8"	<b>AK-1468-20</b>
25,0 cm, 10"	<b>AK-1468-25</b>
30,0 cm, 12"	<b>AK-1468-30</b>

STANDARD	
12,5 cm, 5"	<b>AK-1469-12</b>
15,0 cm, 6"	<b>AK-1469-15</b>

STANDARD	
15,0 cm, 6"	<b>AK-1470-15</b>
23,0 cm, 9"	<b>AK-1470-23</b>
25,0 cm, 10"	<b>AK-1470-25</b>

Pinzetten mit Hartmetalleinlagen  
 Forceps with tungsten carbide inserts  
 Pinzas con bocas de carburo tungsteno  
 Pinze con morsi in carburo di tungsteno



**GILLIES**  
 15,0 cm, 6"  
 AK-1471-15



**MC INDOE**  
 15,0 cm, 6"  
 AK-1472-15



AK-1474-17

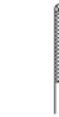

AK-1475-17



**POTTS-SMITH**  
 15,0 cm, 6" **AK-1473-15**  
 18,0 cm, 7" **AK-1473-18**  
 20,0 cm, 8" **AK-1473-20**



**BONNEY**  
 17,5 cm, 6<sup>5</sup>/<sub>8</sub>"  
 AK-1481-17



AK-1476-17

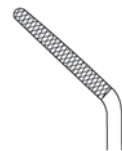

AK-1477-17

**CUSHING**  
 17,5 cm, 6<sup>5</sup>/<sub>8</sub>"

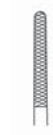

**CUSHING-TAYLOR**  
 18,0 cm, 7"  
 AK-1482-18

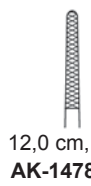

12,0 cm, 4<sup>3</sup>/<sub>4</sub>"  
 AK-1478-12

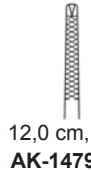

12,0 cm, 4<sup>3</sup>/<sub>4</sub>"  
 AK-1479-12

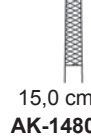

15,0 cm, 6"  
 AK-1480-15

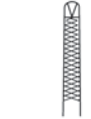

15,0 cm, 6"  
 AK-1483-15

**ADSON**  
 17,5 cm, 6<sup>5</sup>/<sub>8</sub>"

Ai MEDICAL Supply

**Tuch-, Schlauchklemmen, Tupferzangen**

**Towel Clamps, Sponge and Dressing Forceps, Tubing Clamps**

**Pinzas de campo, Pinzas para vendajes y torundas y para tubos**

**Pinze per fissare le compresse, per medicatura e tamponi, e per tubi**



Tuchklemmen  
Towel Clamps  
Pinzas de campo  
Pinze per fissare le compresse



**SCHAEDEL**  
9,0 cm, 3 1/2"  
AK-1484-09



**ENGL. MODELL**  
9,0 cm, 3 1/2"  
AK-1485-09



**JONES**  
5,0 cm, 2" **AK-1486-05**  
7,0 cm, 2 3/4" **AK-1486-07**  
9,0 cm, 3 1/2" **AK-1486-09**



**JONES**  
9,0 cm, 3 1/2"  
AK-1487-09



**BACKHAUS**  
9,0 cm, 3 1/2" **AK-1488-09**  
11,0 cm, 4 3/8" **AK-1488-11**  
13,0 cm, 5" **AK-1488-13**  
15,0 cm, 6" **AK-1488-15**



mit Schlauch- oder Kabelhalter  
with clip for tubing or cable  
con porta-tubo o porta-cavo  
con porta-tubo o porta-cavo

11,0 cm, 4 3/8"  
AK-1489-11



**ROEDER**  
13,0 cm, 5"  
AK-1490-13

Tuchklemmen  
Towel Clamps  
Pinzas de campo  
Pinze per fissare le compresse



**ROEDER**  
15,0 cm, 5"  
AK-1491-15



**BERNHARD**  
16,5 cm, 6 1/2"  
AK-1492-16



13,0 cm, 5"  
AK-1493-13

Kugel / Pfanne  
Ball / Socket  
Bola / Cojinete  
Palla / Cuscinetto



**LORNA**

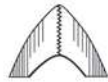

10,0 cm, 4"  
AK-1494-10

13,0 cm, 5"  
AK-1494-13



**LANE**

- |             |            |
|-------------|------------|
| 15,0 cm, 6" | AK-1495-15 |
| 18,0 cm, 7" | AK-1495-18 |
| 20,0 cm, 8" | AK-1495-20 |

Tuchklemmen, Korn- und Tupferzangen  
 Towel Clamps, Sponge and Dressing Forceps  
 Pinzas de campo, Pinzas para vendajes y torundas  
 Pinze per fissare le compresse, Pinze per medicatura e tamponi



**TOHOKU**

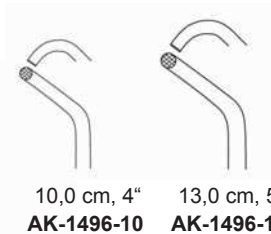

10,0 cm, 4" **AK-1496-10**    13,0 cm, 5" **AK-1496-13**



**PEERS**  
 14,5 cm, 5<sup>3</sup>/<sub>4</sub>"  
**AK-1497-14**



**LISTER**  
 13,0 cm, 5" **AK-1498-13**  
 16,0 cm, 6<sup>1</sup>/<sub>4</sub>" **AK-1498-16**  
 18,0 cm, 7" **AK-1498-18**



**BRYANT**  
 13,0 cm, 5"  
**AK-1499-13**



**BOZEMANN**  
 26,0 cm, 10<sup>1</sup>/<sub>4</sub>"  
**AK-1500-26**



**Korn- und Tupferzangen**  
**Sponge and Dressing Forceps**  
**Pinzas para vendajes y torundas**  
**Pinze per medicatura e tamponi**



**BOZEMANN**  
 26,0 cm, 10<sup>1</sup>/<sub>4</sub>"  
**AK-1501-26**



**COLLIN**  
 25,0 cm, 9<sup>3</sup>/<sub>4</sub>"  
**AK-1502-25**



**CHERON**  
 25,0 cm, 9<sup>3</sup>/<sub>4</sub>"  
**AK-1503-25**



**PERLMANN**  
 25,0 cm, 9<sup>3</sup>/<sub>4</sub>"



**AK-1505-25**



**ULRICH**

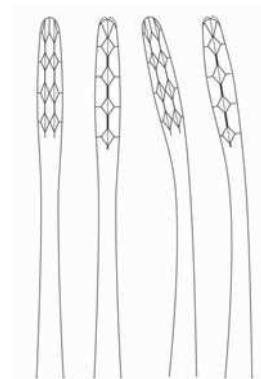

22,0 cm, 8 <sup>5</sup> / <sub>8</sub> "	<b>AK-1506-22</b>	<b>AK-1507-22</b>
25,0 cm, 9 <sup>3</sup> / <sub>4</sub> "	<b>AK-1506-25</b>	<b>AK-1507-25</b>
27,0 cm, 10 <sup>5</sup> / <sub>8</sub> "	<b>AK-1506-27</b>	<b>AK-1507-27</b>

**Korn- und Tupferzangen**  
**Sponge and Dressing Forceps**  
**Pinzas para vendajes y torundas**  
**Pinze per medicatura e tamponi**



20,0 cm, 8"	<b>AK-1508-20</b>	<b>AK-1509-20</b>
22,0 cm, 8 <sup>5</sup> / <sub>8</sub> "	<b>AK-1508-22</b>	<b>AK-1509-22</b>
25,0 cm, 9 <sup>3</sup> / <sub>4</sub> "	<b>AK-1508-25</b>	<b>AK-1509-25</b>
27,0 cm, 10 <sup>5</sup> / <sub>8</sub> "	<b>AK-1508-27</b>	<b>AK-1509-27</b>

**GROSS-MAIER**



25,0 cm, 9 <sup>3</sup> / <sub>4</sub> "	<b>AK-1510-25</b>
25,0 cm, 9 <sup>3</sup> / <sub>4</sub> "	<b>AK-1511-25</b>

**FOERSTER**



18,0 cm, 7"	<b>AK-1512-18</b>	<b>AK-1513-18</b>	<b>AK-1514-18</b>	<b>AK-1515-18</b>
20,0 cm, 8"	<b>AK-1512-20</b>	<b>AK-1513-20</b>	<b>AK-1514-20</b>	<b>AK-1515-20</b>
25,0 cm, 9 <sup>3</sup> / <sub>4</sub> "	<b>AK-1512-25</b>	<b>AK-1513-25</b>	<b>AK-1514-25</b>	<b>AK-1515-25</b>

**FOERSTER-BALLENGER**



<b>RAMPLEY</b>	
18,0 cm, 7"	<b>AK-1516-18</b>
25,0 cm, 9 <sup>3</sup> / <sub>4</sub> "	<b>AK-1516-25</b>

Schlauchklemmen  
Tubing Clamps  
Pinzas para tubos  
Pinze per tubi



**PRESBYTERIAN**

16,5 cm, 6 1/2"	<b>AK-1517-16</b>
18,0 cm, 7"	<b>AK-1517-18</b>
20,0 cm, 8"	<b>AK-1517-20</b>



**BERLIN**

14,5 cm, 5 3/4"	<b>AK-1518-14</b>
-----------------	-------------------

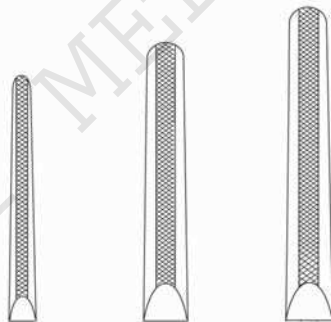

15,0 cm, 6"	18,0 cm, 7"	20,0 cm, 8"
<b>AK-1519-15</b>	<b>AK-1519-18</b>	<b>AK-1519-20</b>

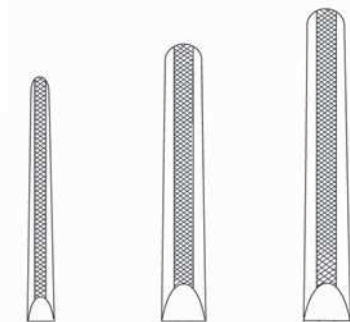

15,0 cm, 6"	18,0 cm, 7"	20,0 cm, 8"
<b>AK-1520-15</b>	<b>AK-1520-18</b>	<b>AK-1520-20</b>



MIT BÜGEL

Ai MEDICAL Supply

**Klemmen**

**Forceps**

**Pinas**

**Pinze**



**Bulldogklemmen**  
**Bulldog Clamps**  
**Clamps Bulldog**  
**Pinze Bulldog**



3,5 cm, 1 1/2" **AK-1521-03 AK-1522-03**  
 5,0 cm, 2" **AK-1521-05 AK-1522-05**



**HESS**  
**AK-1523-01**



**HESS**  
**AK-1524-02**



3,8 cm, 1 1/2" **AK-1525-04 AK-1526-04**  
 5,0 cm, 2" **AK-1525-05 AK-1526-05**  
 6,3 cm, 2 1/2" **AK-1525-06 AK-1526-06**  
 7,6 cm, 3" **AK-1525-07 AK-1526-07**  
 9,0 cm, 3 1/2" **AK-1525-09 AK-1526-09**

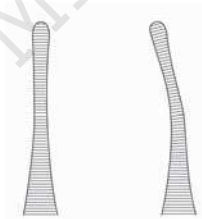

**JOHNS-HOPKINS**



**JOHNS-HOPKINS**  
 23,0 cm, 9"  
**AK-1527-23**



mit atraumatischer Riefung  
 with non-traumatic serration  
 con bocas atraumáticas  
 con presa atraumatica

		L
7,5 cm, 3"	<b>AK-1528-07</b>	2,5 cm, 1"
8,5 cm, 3 <sup>1</sup> / <sub>4</sub> "	<b>AK-1528-08</b>	3,5 cm, 1 <sup>3</sup> / <sub>8</sub> "
10,5 cm, 4 <sup>1</sup> / <sub>8</sub> "	<b>AK-1528-10</b>	5,0 cm, 2"
12,0 cm, 4 <sup>3</sup> / <sub>4</sub> "	<b>AK-1528-12</b>	6,8 cm, 2 <sup>3</sup> / <sub>4</sub> "

**DE BAKEY**

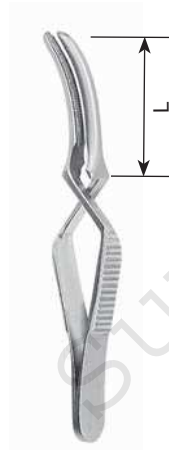

mit atraumatischer Riefung  
 with non-traumatic serration  
 con bocas atraumáticas  
 con presa atraumatica

		L
7,0 cm, 2 <sup>3</sup> / <sub>4</sub> "	<b>AK-1529-07</b>	2,5 cm, 1"
8,0 cm, 3 <sup>1</sup> / <sub>8</sub> "	<b>AK-1529-08</b>	3,5 cm, 1 <sup>3</sup> / <sub>8</sub> "
10,0 cm, 3 <sup>3</sup> / <sub>4</sub> "	<b>AK-1529-10</b>	5,0 cm, 2"
11,5 cm, 4 <sup>1</sup> / <sub>2</sub> "	<b>AK-1529-12</b>	6,8 cm, 2 <sup>3</sup> / <sub>4</sub> "

**DE BAKEY**



**TITANIUM**  
 3,5 cm, 1<sup>3</sup>/<sub>8</sub>"  
 vena **AK-1530-35**  
 arteria **AK-1531-35**



**TITANIUM**  
 3,5 cm, 1<sup>3</sup>/<sub>8</sub>"  
 vena **AK-1532-35**  
 arteria **AK-1533-35**



**TITANIUM**  
 4,0 cm, 1<sup>5</sup>/<sub>8</sub>"  
 vena **AK-1534-40**  
 arteria **AK-1535-40**



**TITANIUM**  
 4,0 cm, 1<sup>5</sup>/<sub>8</sub>"  
 vena **AK-1536-40**  
 arteria **AK-1537-40**

**Bulldogklemmen, Darm- und Gewebefaßzangen**  
**Bulldog Clamps, Intestinal and Tissue Grasping Forceps**  
**Clamps Bulldog, Pinzas intestinales y para tejidos**  
**Pinze Bulldog, Pinze da presa per intestino e tessuti**

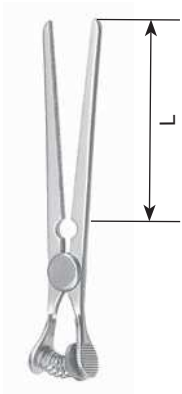

		L	
6,8 cm, 2 <sup>3</sup> / <sub>4</sub> "	<b>AK-1538-07</b>	3,3 cm, 1 <sup>3</sup> / <sub>8</sub> "	
9,6 cm, 3 <sup>3</sup> / <sub>4</sub> "	<b>AK-1538-09</b>	5,0 cm, 2"	
11,7 cm, 4 <sup>3</sup> / <sub>4</sub> "	<b>AK-1538-11</b>	6,9 cm, 2 <sup>3</sup> / <sub>4</sub> "	

**GLOVER**

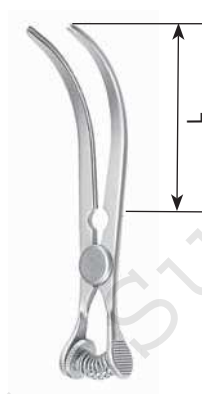

		L	
6,5 cm, 2 <sup>1</sup> / <sub>2</sub> "	<b>AK-1539-06</b>	3,3 cm, 1 <sup>3</sup> / <sub>8</sub> "	
9,1 cm, 3 <sup>1</sup> / <sub>2</sub> "	<b>AK-1539-09</b>	5,0 cm, 2"	
11,0 cm, 4 <sup>3</sup> / <sub>8</sub> "	<b>AK-1539-11</b>	6,9 cm, 2 <sup>3</sup> / <sub>4</sub> "	

**GLOVER**



**CHAPUT**  
 13,0 cm, 5"  
**AK-1540-13**



**TUFFIER**  
 13,0 cm, 5"  
**AK-1541-13**



**COLLIN**  
 16,0 cm, 6<sup>1</sup>/<sub>4</sub>"  
**AK-1542-16**



Darm- und Gewebefaßzangen  
 Intestinal and Tissue Grasping Forceps  
 Pinzas intestinales y para tejidos  
 Pinze da presa per intestino e tessuti



**PENNINGTON**

15,5 cm, 6" **AK-1543-15**  
 20,0 cm, 8" **AK-1543-20**



**ATRAUMA**

25,0 cm, 9<sup>3</sup>/<sub>4</sub>"  
**AK-1544-25**



27,0 cm, 10<sup>1</sup>/<sub>2</sub>"  
**AK-1544-27**



**MARTEL**  
 14,0 cm, 5<sup>1</sup>/<sub>2</sub>"  
**AK-1545-14**



**WILLET-MARTEL**  
 19,0 cm, 7<sup>1</sup>/<sub>2</sub>"  
**AK-1546-19**

Arterienklemmen  
 Haemostatic Forceps  
 Pinzas hemostáticas  
 Pinze emostatiche



**PRATT**  
 15,0 cm, 6"  
 AK-1549-15



**FERGUSSON**

16,0 cm, 6 1/4"	<b>AK-1547-16</b>	<b>AK-1548-16</b>
20,0 cm, 8"	<b>AK-1547-20</b>	<b>AK-1548-20</b>

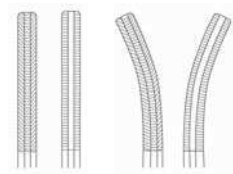

**CARREL**  
 10,0 cm, 4"  
 AK-1550-10



**TERRIER**  
 10,0 cm, 4"  
 AK-1551-10



**KROENLEIN**  
 13,0 cm, 5"  
 AK-1552-13



**PEAN**

14,0 cm, 5½" **AK-1555-14**  
 16,0 cm, 6¼" **AK-1555-16**



**AK-1553-01**

**AK-1554-02**

**BABY-MIXTER**

14,0 cm, 5½"



13,0 cm, 5"	<b>AK-1556-13</b>	<b>AK-1557-13</b>
15,0 cm, 6"	<b>AK-1556-15</b>	<b>AK-1557-15</b>
18,0 cm, 7"	<b>AK-1556-18</b>	<b>AK-1557-18</b>
20,0 cm, 8"	<b>AK-1556-20</b>	<b>AK-1557-20</b>

**SPENCER-WELLS**



**AK-1558-10**

**AK-1559-10**

**HARTMANN**

10,0 cm, 4"

Arterienklemmen  
 Haemostatic Forceps  
 Pinzas hemostáticas  
 Pinze emostatiche



**PROVICENCE-HOSPITAL**  
 14,0 cm, 5½"



**HALSTED-MOSQUITO**

12,5 cm, 5" **AK-1562-12 AK-1563-12**  
 25,0 cm, 9¾" **AK-1562-14 AK-1563-14**

1 x 2 1 x 2  
 12,5 cm, 5" **AK-1564-12 AK-1565-12**  
 25,0 cm, 9¾" **AK-1564-14 AK-1565-14**



**HALSTED-MOSQUITO**

18,0 cm, 7"  
**AK-1565-18**

18,0 cm, 7"  
**AK-1566-18**

21,0 cm, 8¼"  
**AK-1567-21**

21,0 cm, 8¼"  
**AK-1568-21**

1 x 2  
 18,0 cm, 7"  
**AK-1569-18**

1 x 2  
 18,0 cm, 7"  
**AK-1570-18**

1 x 2  
 21,0 cm, 8¼"  
**AK-1571-21**

1 x 2  
 21,0 cm, 8¼"  
**AK-1572-21**



**MICRO-MOSQUITO**

10,0 cm, 4" **AK-1573-10 AK-1574-10 AK-1575-10 AK-1576-10**  
 12,0 cm, 4<sup>3</sup>/<sub>4</sub>" **AK-1573-12 AK-1574-12 AK-1575-12 AK-1576-12**

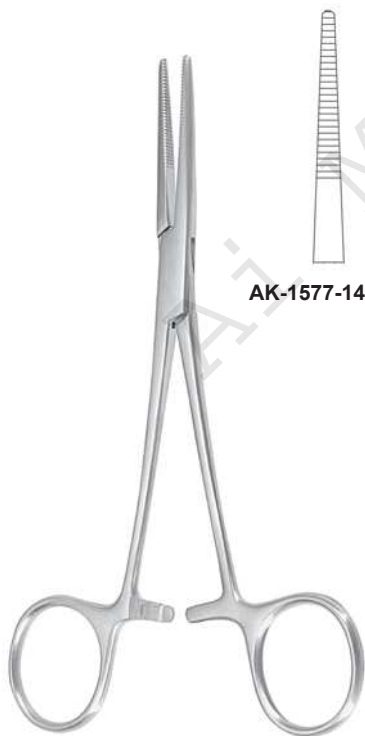
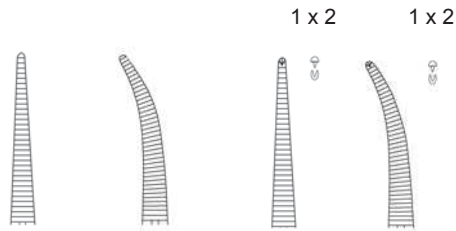

**KELLY**  
 14,0 cm, 5<sup>1</sup>/<sub>2</sub>"

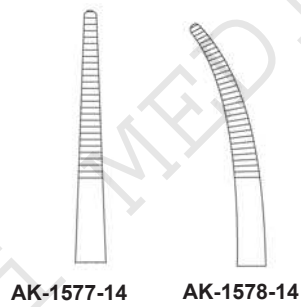

**KELLY-RANKIN**  
 16,0 cm, 6<sup>1</sup>/<sub>4</sub>"

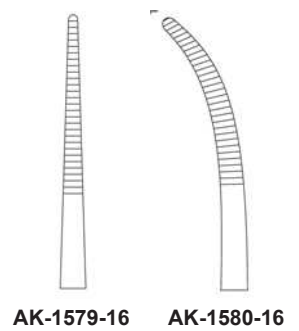

Arterienklemmen  
 Haemostatic Forceps  
 Pinzas hemostáticas  
 Pinze emostatiche



**LERICHE**  
 15,0 cm, 6"



**AK-1581-15**



**AK-1582-15**

1 x 2



**AK-1583-15**

1 x 2



**AK-1584-15**



**BABY-OVERHOLT** 13,5  
 cm, 5 1/4"  
**AK-1585-14**



**DANDY**  
 14,0 cm, 5 1/2"

1 x 2



**AK-1586-14**



**CRILE**  
 14,0 cm, 5 1/2"



**AK-1587-14**



**AK-1588-14**

1 x 2



**AK-1589-14**

1 x 2



**AK-1590-14**

Arterienklemmen  
Haemostatic Forceps  
inzas hemostáticas  
Pinze emostatiche



**DIXON-LOVELACE**  
15,0 cm, 6"

AK-1591-15



AK-1592-15



1 x 2



**BIRKETT**  
19,0 cm, 7½"

AK-1594-19



AK-1595-19



**CRILE-RANKIN**  
16,0 cm, 6¼"

AK-1596-16



AK-1597-16



1 x 2



AK-1598-16



1 x 2



AK-1599-16



Arterienklemmen  
 Haemostatic Forceps  
 Pinzas hemostáticas  
 Pinze emostatiche



AK-1600-19

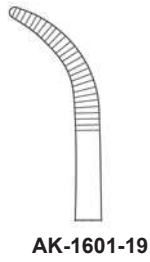

AK-1601-19



AK-1602-19

AK-1603-19

**SCHNIDT**  
 19,0 cm, 7 1/2"

**SCHNIDT-SAWTELL**  
 19,0 cm, 7 1/2"



**ADSON**  
 18,5 cm, 7 1/4"

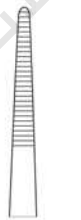

AK-1604-16



AK-1605-16

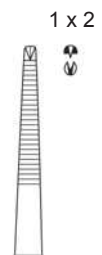

AK-1606-16

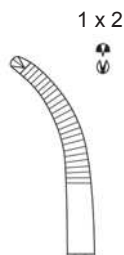

AK-1607-16

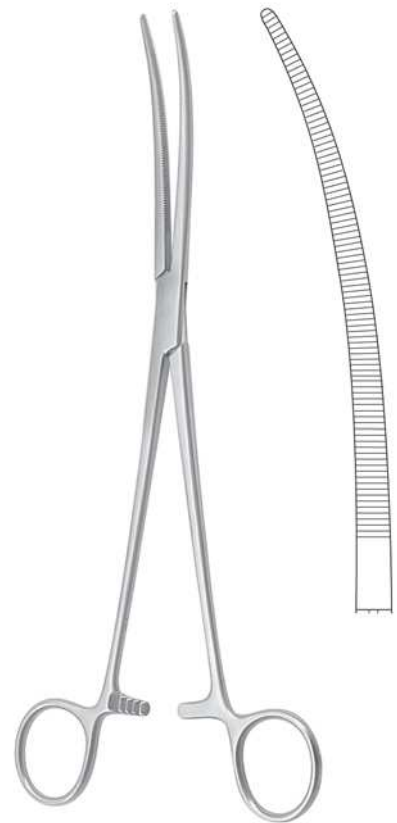

**CRAFOORD**  
 24,0 cm, 9 1/2"  
 AK-1608-24



Arterienklemmen  
 Haemostatic Forceps  
 Pinzas hemostáticas  
 Pinze emostatiche



15,0 cm, 6" **AK-1609-15 AK-1610-15**  
 18,5 cm, 7 1/4" **AK-1609-18 AK-1610-18**

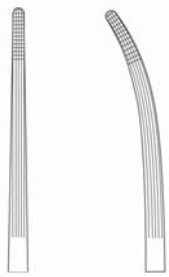

16,0 cm, 6 1/4" **AK-1611-16 AK-1612-16**  
 20,0 cm, 8" **AK-1611-20 AK-1612-20**

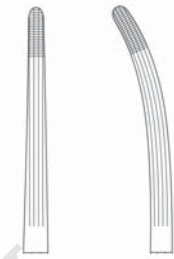

**BAINBRIDGE**

**ROCHESTER-CARMALT**



13,0 cm, 5" **AK-1613-13 AK-1614-13**  
 14,0 cm, 5 1/2" **AK-1613-14 AK-1614-14**  
 16,0 cm, 6 1/4" **AK-1613-16 AK-1614-16**

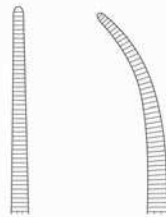

13,0 cm, 5" **AK-1615-13 AK-1616-13**  
 14,0 cm, 5 1/2" **AK-1615-14 AK-1616-14**  
 16,0 cm, 6 1/4" **AK-1615-16 AK-1616-16**

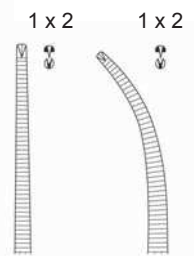

**PEAN DELICATE**

**KOCHER DELICATE**

Arterienklemmen  
 Haemostatic Forceps  
 Pinzas hemostáticas  
 Pinze emostatiche



14,0 cm, 5 1/2"	AK-1617-14	AK-1618-14
16,0 cm, 6 1/4"	AK-1617-16	AK-1618-16
18,0 cm, 7"	AK-1617-18	AK-1618-18
20,0 cm, 8"	AK-1617-20	AK-1618-20
22,0 cm, 8 5/8"	AK-1617-22	AK-1618-22
24,0 cm, 9 1/2"	AK-1617-24	AK-1618-24
26,0 cm, 10 1/4"	AK-1617-26	AK-1618-26
30,0 cm, 12"	AK-1617-30	AK-1618-30

ROCHESTER-PEAN

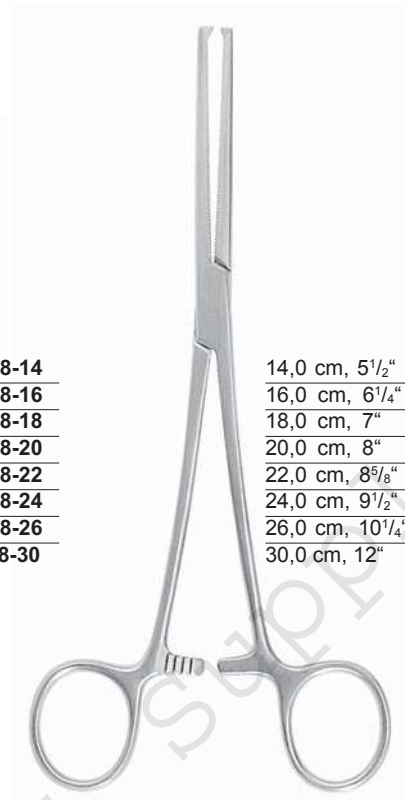

14,0 cm, 5 1/2"	AK-1619-14	AK-1620-14
16,0 cm, 6 1/4"	AK-1619-16	AK-1620-16
18,0 cm, 7"	AK-1619-18	AK-1620-18
20,0 cm, 8"	AK-1619-20	AK-1620-20
22,0 cm, 8 5/8"	AK-1619-22	AK-1620-22
24,0 cm, 9 1/2"	AK-1619-24	AK-1620-24
26,0 cm, 10 1/4"	AK-1619-26	AK-1620-26
30,0 cm, 12"	AK-1619-30	AK-1620-30

KOCHER-OCHSNER



20,0 cm, 8"	AK-1621-20	AK-1622-20	AK-1623-20	AK-1624-20
26,0 cm, 10 1/4"	AK-1621-26	AK-1622-26	AK-1623-26	AK-1624-26

BENGOLEA

Arterienklemmen  
 Haemostatic Forceps  
 Pinzas hemostáticas  
 Pinze emostatiche



AK-1625-20 AK-1626-20 AK-1627-20

**HEISS**  
 20,0 cm, 8"



AK-1628-22 AK-1629-22

**ROBERTS**  
 22,0 cm, 8<sup>5</sup>/<sub>8</sub>"

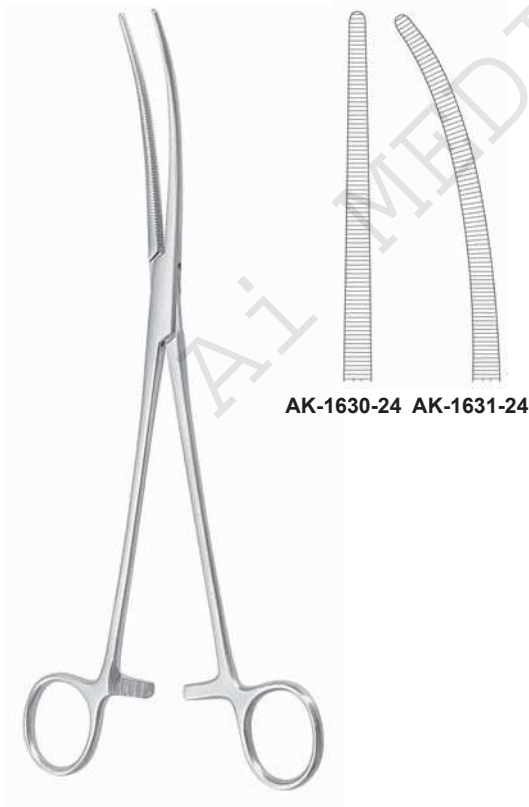

AK-1630-24 AK-1631-24

**SAROT**  
 24,0 cm, 9<sup>1</sup>/<sub>2</sub>"



AK-1632-01 AK-1633-02

**NEGUS**  
 19,0 cm, 7<sup>1</sup>/<sub>2</sub>"

**Präparier- und Ligaturklemmen**  
**Dissecting and Ligature Forceps**  
**Pinzas de disección y ligaduras**  
**Pinze per preparazioni e legature**



14,0 cm, 5½"  
**AK-1634-14**

18,0 cm, 7"  
**AK-1635-18**

**BABY-ADSON**



**MICRO-ADSON**  
 14,0 cm, 5½"  
**AK-1636-14**

**JOHNS HOPKINS**  
 20,0 cm, 8"  
**AK-1639-20**



**BABY-MIXTER**  
 18,0 cm, 7"  
**AK-1637-18**



**OVERHOLT-MIXTER**  
 21,0 cm, 8¼"  
**AK-1638-21**



Präparier- und Ligaturklemmen  
 Dissecting and Ligature Forceps  
 Pinzas de disección y ligaduras  
 Pinze per preparazioni e legature



**OVERHOLT**

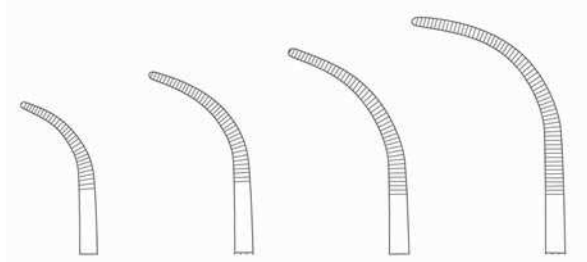

18,5 cm, 7<sup>1</sup>/<sub>4</sub>" **AK-1640-01**    20,0 cm, 8" **AK-1640-02**    21,0 cm, 8<sup>1</sup>/<sub>4</sub>" **AK-1640-03**    21,5 cm, 8<sup>1</sup>/<sub>2</sub>" **AK-1640-04**



**RUMEL**  
 23,0 cm, 9"

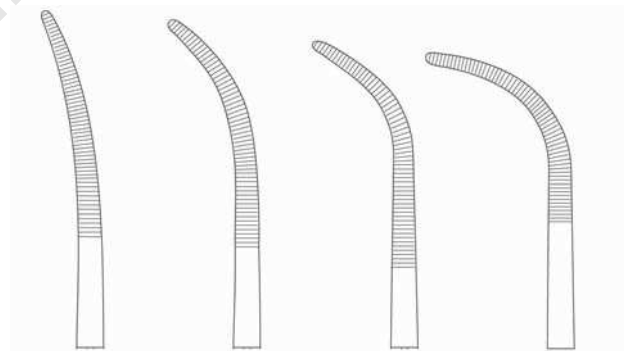

**AK-1641-01**    **AK-1641-02**    **AK-1641-03**    **HF-1641-04**

**Präparier- und Ligaturklemmen**  
**Dissecting and Ligature Forceps**  
**Pinzas de disección y ligaduras**  
**Pinze per preparazioni e legature**



**OVERHOLT-GEISSENDOERFER**

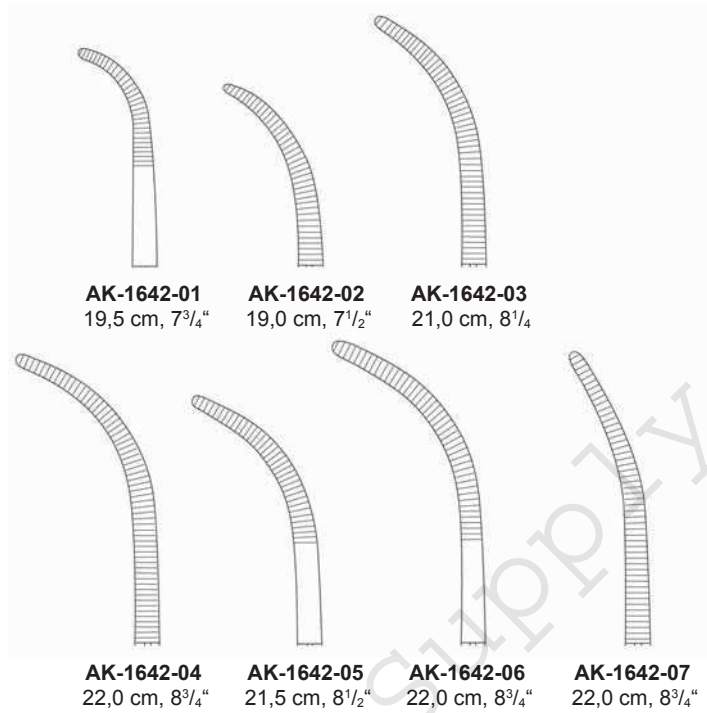

**OVERHOLT-GEISSENDOERFER**

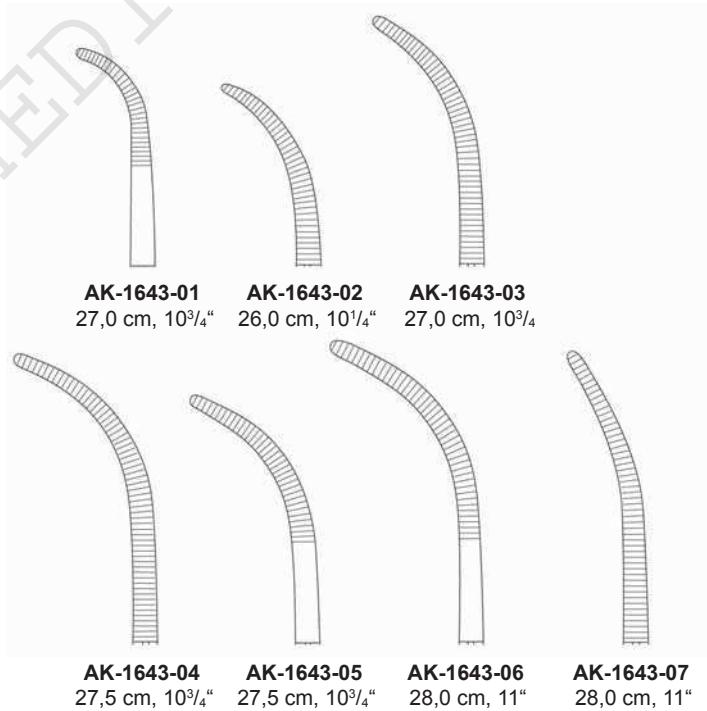

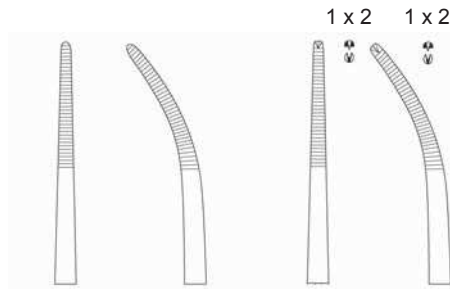

21,0 cm, 8<sup>1</sup>/<sub>4</sub>" AK-1644-21 AK-1645-21 AK-1646-21 AK-1647-21  
 26,0 cm, 10<sup>1</sup>/<sub>4</sub>" AK-1644-26 AK-1645-26 AK-1646-26 AK-1647-26

TOENNIS



19,0 cm, 7<sup>1</sup>/<sub>2</sub>" AK-1648-19 AK-1649-19 AK-1650-19  
 22,0 cm, 8<sup>5</sup>/<sub>8</sub>" AK-1648-22 AK-1649-22 AK-1650-22  
 24,0 cm, 9<sup>1</sup>/<sub>2</sub>" AK-1648-24 AK-1649-24 AK-1650-24

KELLY

**Präparier- und Ligaturklemmen**  
**Dissecting and Ligature Forceps**  
**Pinzas de disección y ligaduras**  
**Pinze per preparazioni e legature**



18,0 cm, 7"	<b>AK-1651-18</b>
22,0 cm, 8 <sup>5</sup> / <sub>8</sub> "	<b>AK-1651-22</b>
25,0 cm, 9 <sup>3</sup> / <sub>4</sub> "	<b>AK-1651-25</b>
28,0 cm, 11"	<b>AK-1651-28</b>

**MINI-GEMINI**



14,0 cm, 5 <sup>1</sup> / <sub>2</sub> "	<b>AK-1652-14</b>
16,0 cm, 6 <sup>1</sup> / <sub>4</sub> "	<b>AK-1652-16</b>
18,0 cm, 7"	<b>AK-1652-18</b>
20,0 cm, 8"	<b>AK-1652-20</b>
23,0 cm, 9"	<b>AK-1652-23</b>
25,0 cm, 9 <sup>3</sup> / <sub>4</sub> "	<b>AK-1652-25</b>
28,0 cm, 11"	<b>AK-1652-28</b>

**GEMINI**



20,0 cm, 8"	<b>AK-1653-20</b>
24,0 cm, 9 <sup>1</sup> / <sub>2</sub> "	<b>AK-1653-24</b>
28,0 cm, 11"	<b>AK-1653-28</b>

**KANTROWITZ**



19,0 cm, 7 <sup>1</sup> / <sub>2</sub> "	<b>AK-1654-19</b>
21,0 cm, 8 <sup>1</sup> / <sub>4</sub> "	<b>AK-1654-21</b>
24,0 cm, 9 <sup>1</sup> / <sub>2</sub> "	<b>AK-1654-24</b>

**WIKSTROEM**



Präparier- und Ligaturklemmen  
 Dissecting and Ligature Forceps  
 Pinzas de disección y ligaduras  
 Pinze per preparazioni e legature



**MIXTER**  
 15,5 cm, 6" **AK-1655-15**  
 19,0 cm, 7½" **AK-1655-19**



**MIXTER-O'SHAUGNESSY**  
 15,5 cm, 6" **AK-1656-15**  
 19,0 cm, 7½" **AK-1656-19**



**MIXTER**  
 22,0 cm, 8¾" **AK-1657-22**



**MIXTER**  
 23,0 cm, 9" **HF-1473-23**



**ZENKER**

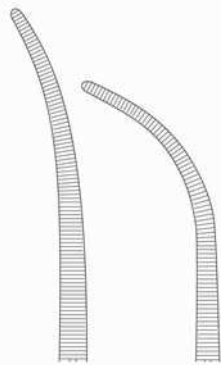

**AK-1658-01** **AK-1659-02**



**ZENKER**

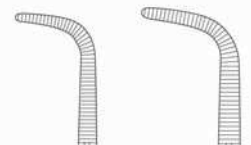

**AK-1660-18** **AK-1661-28**

Präparier- und Ligaturklemmen  
 Dissecting and Ligature Forceps  
 Pinzas de disección y ligaduras  
 Pinze per preparazioni e legature



**LAWRENCE**  
 27,5 cm, 10<sup>3</sup>/<sub>4</sub>"  
 AK-1664-28

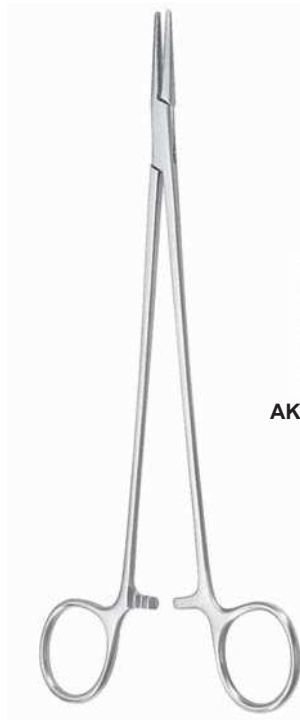

**HOSEMANN**  
 21,0 cm, 8<sup>1</sup>/<sub>4</sub>"

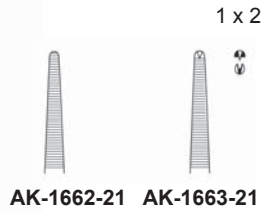

**DESJARDINS**  
 21,0 cm, 8<sup>1</sup>/<sub>4</sub>"  
 AK-1665-21



**MIXTER**  
 22,0 cm, 8<sup>3</sup>/<sub>4</sub>" AK-1666-22  
 25,0 cm, 9<sup>3</sup>/<sub>4</sub>" AK-1666-25  
 28,0 cm, 11" AK-1666-28

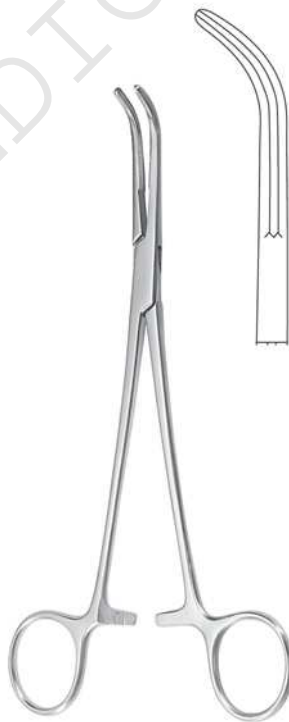

**LAHEY**  
 19,0 cm, 7<sup>1</sup>/<sub>2</sub>" AK-1667-19  
 23,0 cm, 9" AK-1667-23



**LOWER**  
 18,0 cm, 7"  
 AK-1668-18

Präparier- und Ligaturklemmen  
 Dissecting and Ligature Forceps  
 Pinzas de disección y ligaduras  
 Pinze per preparazioni e legature



**MC QUIGG-MIXTER**  
 22,0 cm, 8<sup>3</sup>/<sub>4</sub>"  
 AK-1671-22

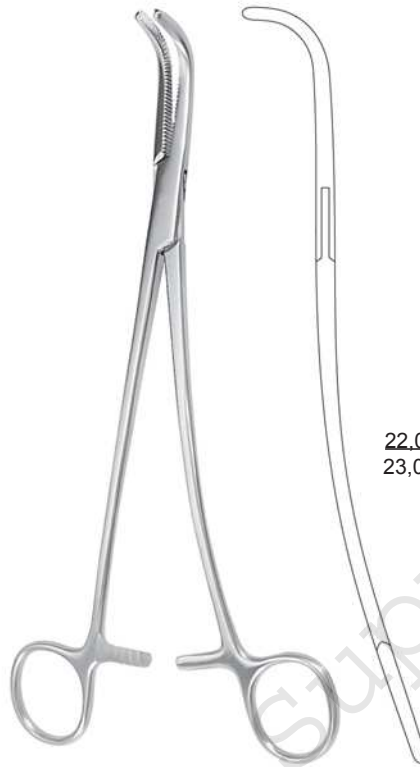

**GRAY**

22,0 cm, 8<sup>3</sup>/<sub>4</sub>" AK-1669-22 AK-1670-22  
 23,0 cm, 9" AK-1669-23 AK-1670-23

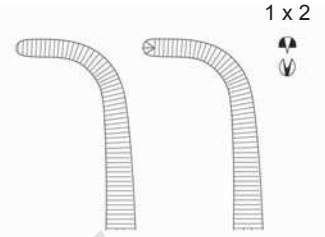

**CRAFOORD-SELLORS**

22,0 cm, 8<sup>3</sup>/<sub>4</sub>"  
 AK-1672-22

23,0 cm, 9"  
 AK-1673-23

24,0 cm, 9<sup>1</sup>/<sub>2</sub>"  
 AK-1674-24



**FINOCCHIETTO**  
 24,0 cm, 9<sup>1</sup>/<sub>2</sub>"  
 AK-1675-24

Gallenkanal- und Nierenstiellklemmen  
 Gall Duct and Kidney Pedicle Clamps  
 Pinzas-clamps para pedúnculo renal  
 Pinze per peduncoli renali



**GUYON**  
 20,0 cm, 8" **AK-1676-20**  
 22,0 cm, 8<sup>3</sup>/<sub>4</sub>" **AK-1676-22**  
 24,0 cm, 9<sup>1</sup>/<sub>2</sub>" **AK-1676-24**



**GUYON**  
 23,0 cm, 9"  
**AK-1677-23**



23,0 cm, 9"  
**AK-1678-23**

24,0 cm, 9<sup>1</sup>/<sub>2</sub>"  
**AK-1679-24**

**GUYON**



**STILLE**  
 23,0 cm, 9"  
**AK-1680-23**

Gallenkanal- und Nierenstielklemmen, Bronchusklemmen  
 Gall Duct and Kidney Pedicle Clamps, Bronchus Forceps  
 Pinzas-clamps para pedúnculo renal, Pinzas-clamps para bronquios  
 Pinze per peduncoli renali, Pinze per legature



**HERRICK**  
 23,0 cm, 9"  
 AK-1681-23



**URO-TANGENTIAL**  
 26,0 cm, 10 1/4"

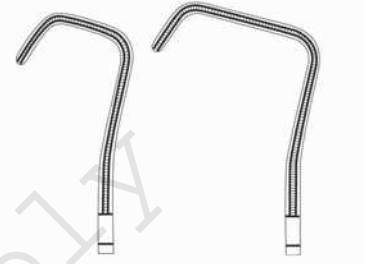

23,0 cm, 9"  
 AK-1682-01

24,0 cm, 9 1/2"  
 AK-1683-02



**LOVELACE**  
 20,0 cm, 8"  
 AK-1684-20



**LOVELACE**  
 20,0 cm, 8"  
 AK-1685-20



**PRICE-THOMAS**  
 22,0 cm, 8 3/4"  
 AK-1686-22

Bronchusklemmen, Peritoneumklemmen, Hysterektomieklemmen  
 Bronchus Forceps, Peritoneum Forceps, Hysterectomy Forceps  
 Pinzas-clamps para bronquios, Pinzas-clamps para peritoneo y para histerectomía  
 Pinze per legature, Pinze per peritoneo e per isterectomia



**PRICE-THOMAS**  
 22,0 cm, 8<sup>3</sup>/<sub>4</sub>"

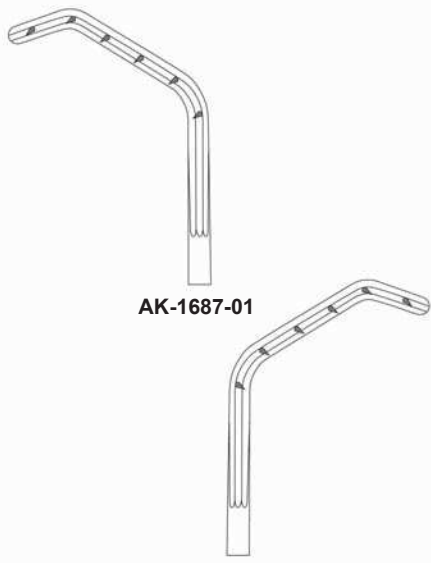

**AK-1687-01**

**AK-1688-02**



**AK-1689-01**

**AK-1690-02**

**SEMB**  
 24,0 cm, 9<sup>1</sup>/<sub>2</sub>"



**BABY-  
 MIKULICZ 14,0**  
 cm, 5<sup>1</sup>/<sub>2</sub>"  
**AK-1691-14**

1 x 2



**MIKULICZ**  
 18,0 cm, 7"  
**AK-1692-18**

1 x 2



**MIKULICZ**  
 20,0 cm, 8"  
**AK-1693-20**

1 x 2



Peritoneumklemmen, Hysterektomieklemmen  
 Peritoneum Forceps, Hysterectomy Forceps  
 Pinzas-clamps para peritoneo y para histerectomía  
 Pinze per peritoneo e per isterectomia

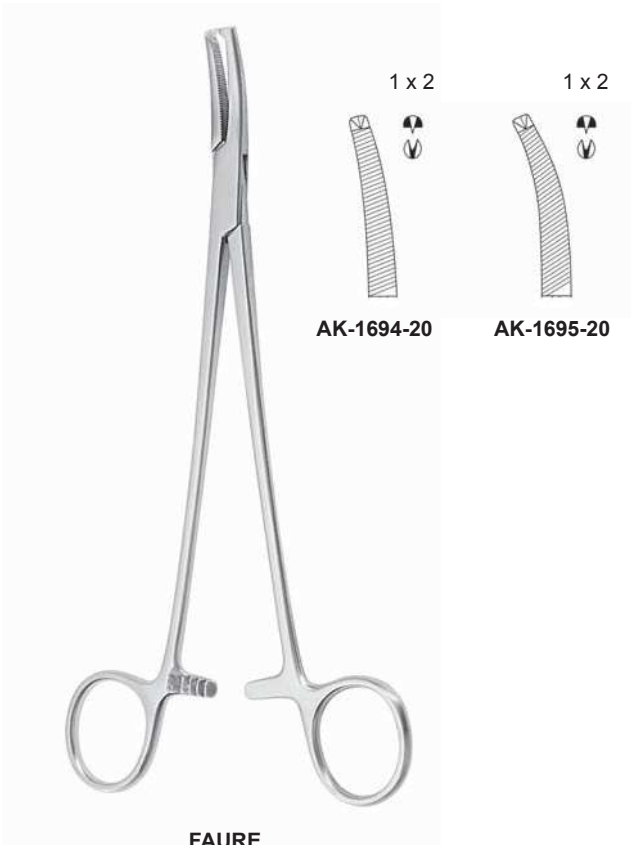

**FAURE**  
 20,0 cm, 8"

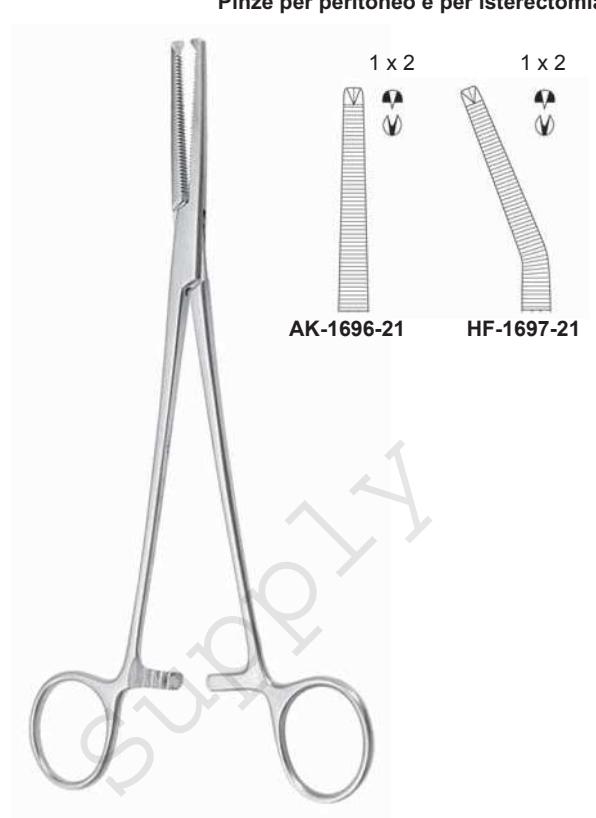

**PHANEUF**  
 21,5 cm, 8½"



**WERTHEIM**  
 24,0 cm, 9½"  
 HF-1698-24



**WERTHEIM**  
 25,0 cm, 10"  
 HF-1699-25

**Hysterektomieklemmen**  
**Hysterectomy Forceps**  
**Pinzas-clamps para histerectomía**  
**Pinze per isterectomia**



**WERTHEIM**  
 23,0 cm, 9"

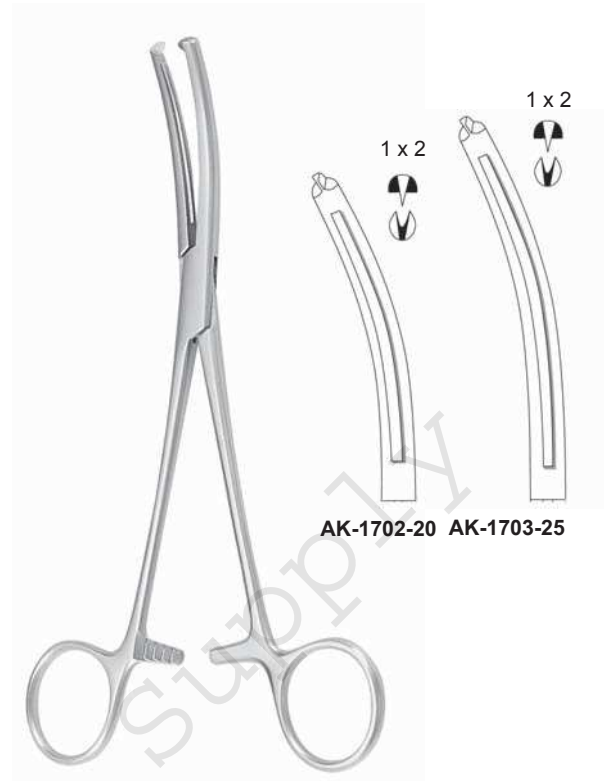

**MAINGOT**  
 21,5 cm, 8½"

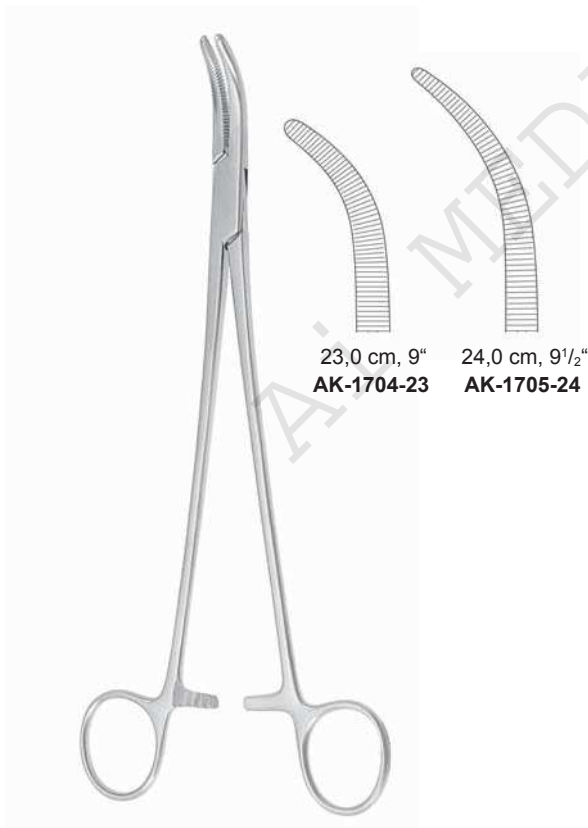

**MOYNIHAN**



**WERTHEIM-CULLEN**  
 21,5 cm, 8½"  
 AK-1706-21



Hysterektomieklemmen  
 Hysterectomy Forceps  
 Pinzas-clamps para histerectomía  
 Pinze per isterectomia



**LONG**  
 19,0 cm, 7 1/4"  
 AK-1707-19

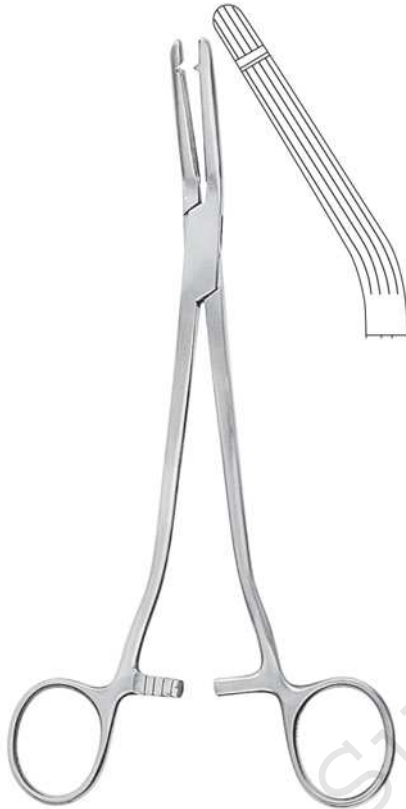

**GARLAND**  
 21,0 cm, 8 1/4"  
 AK-1708-21



**HEANEY**  
 21,0 cm, 8 1/4"  
 AK-1709-21

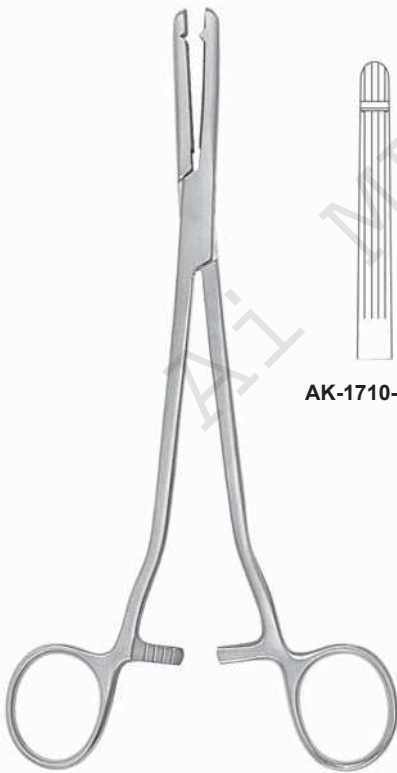

**HEANEY-BALLANTINE**  
 21,0 cm, 8 1/4"

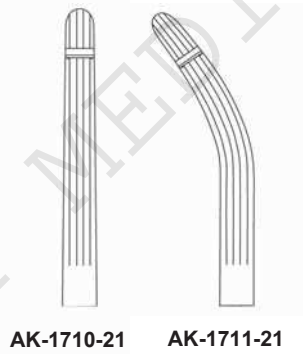

AK-1710-21

AK-1711-21

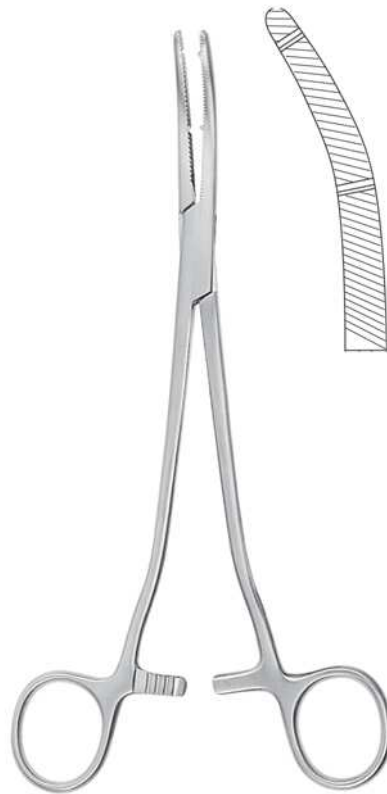

**HEANEY-KANTER**  
 21,0 cm, 8 1/4"  
 AK-1712-21

Hysterektomieklappen  
Hysterectomy Forceps  
Pinzas-clamps para histerectomía  
Pinze per isterectomia

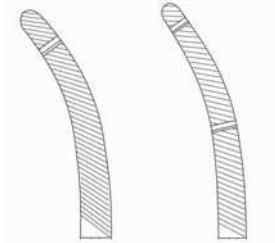

21,0 cm, 8<sup>1</sup>/<sub>4</sub>" AK-1713-21 AK-1714-21  
23,0 cm, 9" AK-1713-23 AK-1714-23

Ai MEDICAL SUPPLY

**Nahtinstrumente**  
**Suture Instruments**  
**Instrumentos para sutura**  
**Strumenti per sutura**



**Nadelhalter**  
**Needle Holders**  
**Porta-agujas**  
**Portaghi**



**AK-1715-12**  
 12,0 cm, 4<sup>3</sup>/<sub>4</sub>"



**AK-1716-12**  
 12,5 cm, 5"



**COLLIER**  
 12,5 cm, 5"  
**AK-1717-12**



**WEBSTER**  
 13,0 cm, 5"  
**AK-1718-13**



**HALSEY**  
 13,0 cm, 5"

**AK-1719-13** **AK-1720-13**



**NEIVERT**  
 13,0 cm, 5"  
**AK-1721-13**



**HEGAR-BAUMGARTNER**  
 14,0 cm, 5<sup>1</sup>/<sub>2</sub>"  
**AK-1722-14**

Nadelhalter  
Needle Holders  
Porta-agujas  
Portaghi



**AK-1723-13**  
13,0 cm, 5"

**BROWN**



**CRILE-MURRAY**  
15,0 cm, 6"  
**AK-1725-15**

**CRILE-MURRAY**  
15,0 cm, 6"  
**AK-1725-15**



**AK-1724-15**  
15,0 cm, 6"

**CRILE-WOOD**



**ADSON**  
18,0 cm, 7"  
**AK-1726-18**

**ADSON**  
18,0 cm, 7"  
**AK-1726-18**



**METZENBAUM**  
18,0 cm, 7"  
**AK-1727-18**

**METZENBAUM**  
18,0 cm, 7"  
**AK-1727-18**



**MASS.-GENERAL-HOSPITAL**  
17,0 cm, 6<sup>3</sup>/<sub>4</sub>"  
**AK-1728-17**

**MASS.-GENERAL-HOSPITAL**  
17,0 cm, 6<sup>3</sup>/<sub>4</sub>"  
**AK-1728-17**

**Nadelhalter  
Needle Holders  
Porta-agujas  
Portaghi**



**MAYO-HEGAR**

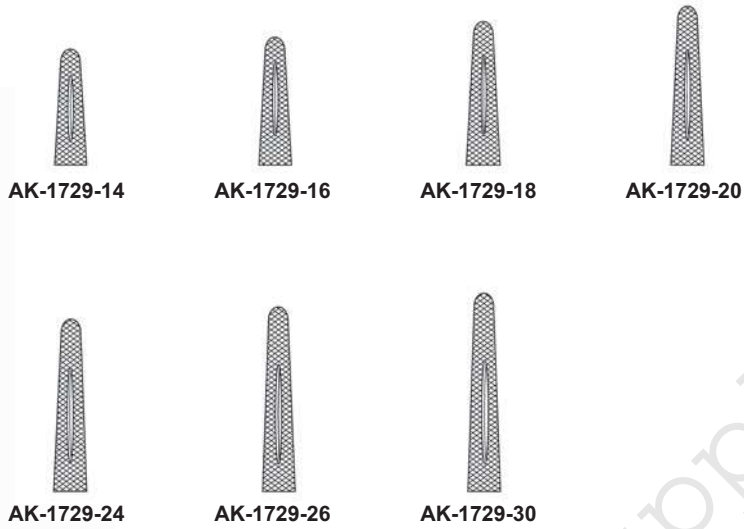

**MAYO-HEGAR-DELICATE**



**LAWRENCE**  
15,0 cm, 6"  
AK-1731-15

Nadelhalter  
Needle Holders  
Porta-agujas  
Portaghi



**HEANEY**  
21,0 cm, 8<sup>1</sup>/<sub>4</sub>"  
AK-1732-21



**JAMISON**  
23,5 cm, 9<sup>1</sup>/<sub>4</sub>"  
AK-1733-23



**MASSON**  
27,0 cm, 10<sup>1</sup>/<sub>2</sub>"  
AK-1734-27



**FINOCCHIETTO**  
27,0 cm, 10<sup>1</sup>/<sub>2</sub>"  
AK-1735-27



**WANGENSTEEN**  
27,0 cm, 10<sup>1</sup>/<sub>2</sub>"  
AK-1736-27



**JOHNSON**  
27,0 cm, 10<sup>1</sup>/<sub>2</sub>"  
AK-1737-27

**Nadelhalter**  
**Needle Holders**  
**Porta-agujas**  
**Portaghi**

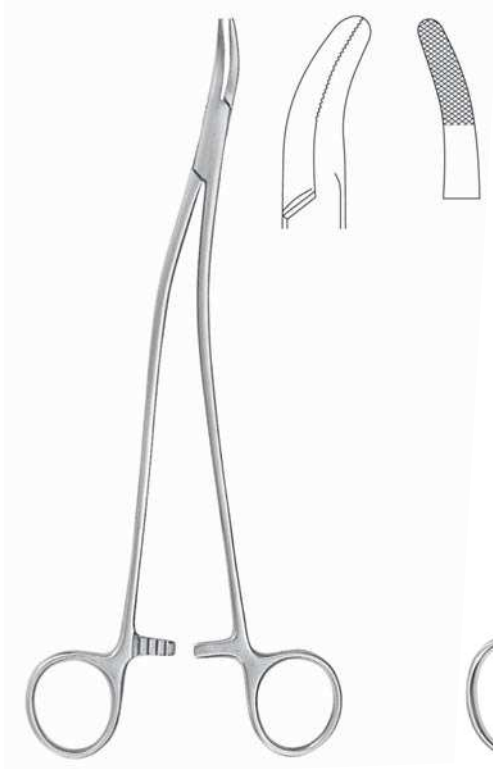

**STRATTE**  
 23,0 cm, 9"  
**AK-1738-23**



**OLSEN-HEGAR**  
 17,0 cm, 6<sup>3</sup>/<sub>4</sub>"  
**AK-1739-17**



**OLSEN-HEGAR**  
 14,0 cm, 5<sup>1</sup>/<sub>2</sub>"  
**AK-1740-14**



14,0 cm, 5<sup>1</sup>/<sub>2</sub>"  
**AK-1741-14**

18,0 cm, 7"  
**AK-1741-18**

**OLSEN-HEGAR**



**TOENNIS**  
 18,0 cm, 7"  
**AK-1742-18**



Nadelhalter  
Needle Holders  
Porta-agujas  
Portaghi



**AK-1743-14**  
14,0 cm, 5½"

**MATHIEU**



**AK-1743-17**  
17,0 cm, 6¾"



**AK-1743-20**  
20,0 cm, 8"



**AK-1744-17**  
17,0 cm, 6¾"



**AK-1744-20**  
20,0 cm, 8"

**MATHIEU**



**LICHTENBERG**  
20,0 cm, 8"  
**AK-1746-20**



**MATHIEU**

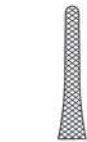

**AK-1745-14**  
14,0 cm, 5½"



**AK-1745-17**  
17,0 cm, 6¾"

**Nadelhalter, Mikro-Nadelhalter**  
**Needle Holders, Micro Needle Holders**  
**Porta-agujas, Micro Porta-agujas**  
**Portaghi, Micro Portaghi**



**MATHIEU-KOCHER**



**AK-1747-14**  
14,0 cm, 5 1/2"

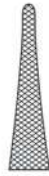

**AK-1747-17**  
17,0 cm, 6 3/4"



**AK-1747-20**  
20,0 cm, 8"



**AK-1748-10**



**AK-1749-10**



**BARRAQUER-TROUTMAN**  
10,0 cm, 4"



**BARRAQUER**



**AK-1750-10**



**AK-1751-10**



**BARRAQUER**  
13,5 cm, 5 3/8"  
**AK-1752-13**



**GOMEL**  
14,0 cm, 5 1/2"  
**AK-1753-14**





AK-1754-18 AK-1755-18

ohne Sperre  
 without ratchet  
 sin cremallera  
 senza cremagliera

18,5 cm, 7 1/4"



AK-1757-18 AK-1758-18

mit Sperre  
 with ratchet  
 con cremallera  
 con cremagliera

18,5 cm, 7 1/4"



AK-1759-14



AK-1760-14

mit Sperre  
 with ratchet  
 con cremallera  
 con cremagliera

CASTROVIEJO  
 14,5 cm, 5 3/4"



AK-1763-18



AK-1764-18



AK-1765-18



AK-1766-18

mit Sperre  
 with ratchet  
 con cremallera  
 con cremagliera

CASTROVIEJO  
 18,0 cm, 7"

**Mikro-Nadelhalter**  
**Micro Needle Holders**  
**Micro Porta-agujas**  
**Micro Portaghi**

0,4 mm



gerade, ohne Sperre  
 straight, without ratchet  
 recta, sin cremallera  
 retta, senza cremagliera

14,0 cm, 5 1/2"  
**AK-1767-14**

0,4 mm



gebogen, ohne Sperre  
 curved, without ratchet  
 curva, sin cremallera  
 curva, senza cremagliera

14,0 cm, 5 1/2"  
**AK-1768-14**

0,4 mm



14,0 cm, 5 1/2"  
**AK-1769-14**

0,5 mm



gebogen, ohne Sperre  
 curved, without ratchet  
 curva, sin cremallera  
 curva, senza cremagliera

Ø 10 mm

14,0 cm, 5 1/2"  
**AK-1770-14**

0,5 mm



gebogen, ohne Sperre  
 curved, without ratchet  
 curva, sin cremallera  
 curva, senza cremagliera

Ø 10 mm

14,0 cm, 5 1/2"  
**AK-1771-14**

0,4 mm



gebogen, ohne Sperre  
 curved, without ratchet  
 curva, sin cremallera  
 curva, senza cremagliera

Ø 8 mm

13,0 cm, 5"  
**AK-1772-13**

0,4 mm



gebogen, ohne Sperre  
 curved, without ratchet  
 curva, sin cremallera  
 curva, senza cremagliera

Ø 8 mm

13,0 cm, 5"  
**AK-1773-13**

Nadelhalter mit Hartmetalleinlagen  
 Needle Holders with tungsten carbide inserts  
 Porta-agujas con bocas de carburo tungsteno  
 Portaghi con morsi in carburo di tungsteno



**KALT**  
 13,5 cm, 5<sup>3</sup>/<sub>8</sub>"  
 AK-1776-14



**DIETRICH**

- 16,0 cm, 5<sup>3</sup>/<sub>8</sub>" **AK-1775-16**
- 18,0 cm, 7" **AK-1775-18**
- 20,0 cm, 8" **AK-1775-20**
- 23,0 cm, 9" **AK-1775-23**
- 26,0 cm, 10<sup>1</sup>/<sub>4</sub>" **AK-1775-26**



**WEBSTER**  
 13,0 cm, 5"  
 AK-1777-13



**DERF**  
 12,0 cm, 4<sup>3</sup>/<sub>4</sub>"  
 AK-1780-12



**HEGAR-BAUMGARTNER**

**AK-1778-12**  
 12,5 cm, 5"

**AK-1779-14**  
 14,0 cm, 5<sup>1</sup>/<sub>2</sub>"



**WEBSTER**  
 13,0 cm, 5"  
 AK-1781-13

**Nadelhalter mit Hartmetalleinlagen**  
**Needle Holders with tungsten carbide inserts**  
**Porta-agujas con bocas de carburo tungsteno**  
**Portaghi con morsi in carburo di tungsteno**



**AK-1782-13**

**AK-1783-13**



**AK-1784-15**  
15,0 cm, 6"

**AK-1784-18**  
18,0 cm, 7"

**HALSEY**  
13,0 cm, 5"

**CRILE-WOOD**



**AK-1785-18**  
18,0 cm, 7"

**AK-1785-20**  
20,0 cm, 8"

**AK-1785-26**  
26,0 cm, 10 1/4"

**SAROT**

Nadelhalter mit Hartmetalleinlagen  
 Needle Holders with tungsten carbide inserts  
 Porta-agujas con bocas de carburo tungsteno  
 Portaghi con morsi in carburo di tungsteno



MAYO-HEGAR



AK-1786-16  
 16,0 cm, 6 1/4"



AK-1786-18  
 18,0 cm, 7"



AK-1786-20  
 20,0 cm, 8"



AK-1786-24  
 24,0 cm, 9 1/2"



AK-1786-26  
 26,0 cm, 10 1/4"



AK-1786-30  
 30,0 cm, 12"



MAYO-HEGAR (HEANEY)



AK-1787-20  
 20,0 cm, 8"



AK-1787-24  
 24,0 cm, 9 1/4"



AK-1787-26  
 26,0 cm, 10 1/4"

**Nadelhalter mit Hartmetalleinlagen**  
**Needle Holders with tungsten carbide inserts**  
**Porta-agujas con bocas de carburo tungsteno**  
**Portaghi con morsi in carburo di tungsteno**

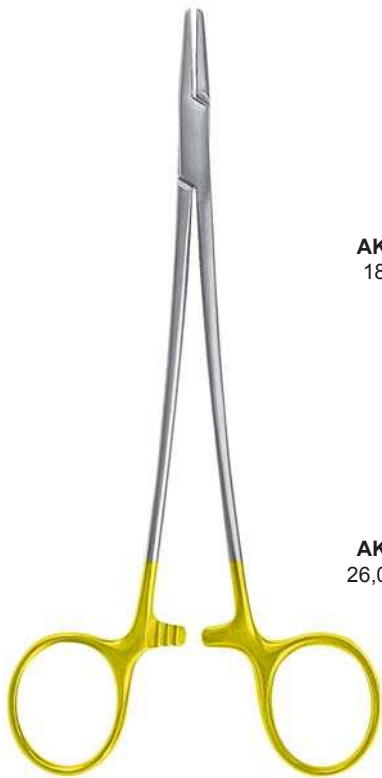

**DE BAKEY**



**AK-1788-18**  
18,0 cm, 7"



**AK-1788-20**  
20,0 cm, 8"



**AK-1788-23**  
23,0 cm, 9"



**AK-1788-26**  
26,0 cm, 10 1/4"



**AKTC-1788-31**  
31,0 cm, 12 1/4"



**AK-1788-37**  
37,0 cm, 14 1/2"

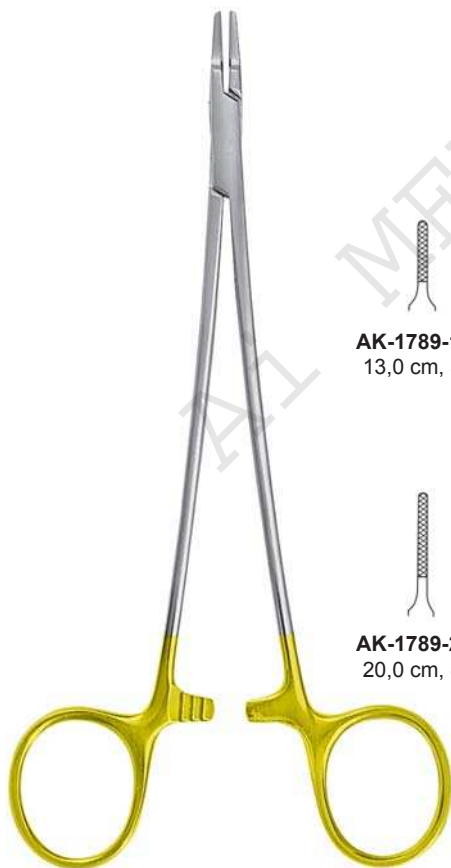

**RYDER-VASCULAR**



**AK-1789-13**  
13,0 cm, 5"



**AK-1789-15**  
15,0 cm, 6"

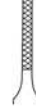

**AK-1789-18**  
18,0 cm, 7"



**AK-1789-20**  
20,0 cm, 8"



**AK-1789-23**  
23,0 cm, 9"



**AK-1789-26**  
26,0 cm, 10 1/4"



Nadelhalter mit Hartmetalleinlagen  
 Needle Holders with tungsten carbide inserts  
 Porta-agujas con bocas de carburo tungsteno  
 Portaghi con morsi in carburo di tungsteno



RYDER



AK-1790-13  
13,0 cm, 5"

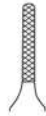

AK-1790-15  
15,0 cm, 6"

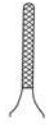

AK-1790-18  
18,0 cm, 7"

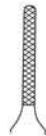

AK-1790-20  
20,0 cm, 8"

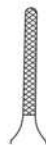

AK-1790-23  
23,0 cm, 9"



AK-1790-26  
26,0 cm, 10 1/4"



SCHWEDISCHES MODELL



AK-1791-15  
15,0 cm, 6"



AK-1791-17  
17,0 cm, 6 3/4"



AK-1791-20  
20,0 cm, 8"

**Nadelhalter mit Hartmetalleinlagen**  
**Needle Holders with tungsten carbide inserts**  
**Porta-agujas con bocas de carburo tungsteno**  
**Portaghi con morsi in carburo di tungsteno**

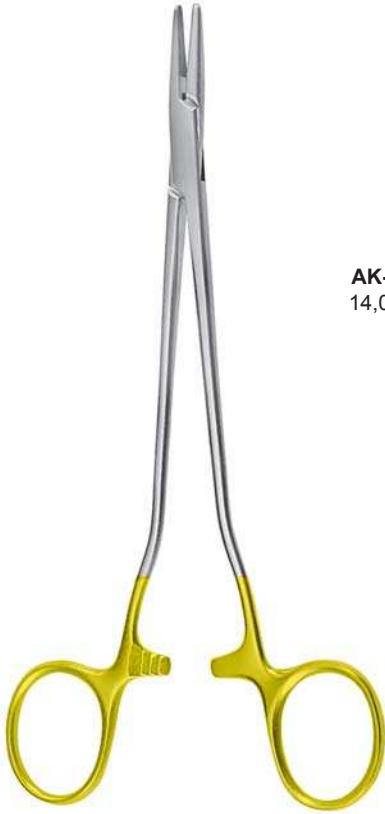

**MAYO-HEGAR (HEANEY)**



**AK-1792-14**  
14,0 cm, 5½"



**AK-1792-18**  
18,0 cm, 7"



**AK-1792-20**  
20,0 cm, 8"



**AK-1792-23**  
23,0 cm, 9"



**FINOCCHIETTO**  
27,0 cm, 10½"  
**AK-1793-27**



**MASSON**  
27,0 cm, 10½"  
**AK-1794-27**



**WANGENSTEEN**  
27,0 cm, 10½"  
**AK-1795-27**

Nadelhalter mit Hartmetalleinlagen  
 Needle Holders with tungsten carbide inserts  
 Porta-agujas con bocas de carburo tungsteno  
 Portaghi con morsi in carburo di tungsteno



**BOZEMANN**



**AK-1796-20**  
20,0 cm, 8"



**AK-1796-24**  
24,0 cm, 9<sup>5</sup>/<sub>8</sub>"



**AK-1796-26**  
26,0 cm, 10<sup>1</sup>/<sub>4</sub>"



**HEGAR**



**AK-1797-20**  
20,0 cm, 8"



**AK-1797-24**  
24,0 cm, 9<sup>5</sup>/<sub>8</sub>"



**BARRY STERNAL**



**AK-1798-15**  
15,0 cm, 6"



**AK-1798-20**  
20,0 cm, 8"

**Nadelhalter mit Hartmetalleinlagen**  
**Needle Holders with tungsten carbide inserts**  
**Porta-agujas con bocas de carburo tungsteno**  
**Portaghi con morsi in carburo di tungsteno**



**STRATTE**

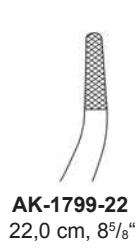

**AK-1799-22**  
22,0 cm, 8<sup>5</sup>/<sub>8</sub>"



**AK-1799-23**  
23,0 cm, 9"



**GILLIES**  
16,0 cm, 6<sup>1</sup>/<sub>4</sub>"  
**AK-1800-16**



**OLSEN-HEGAR**



**AK-1801-14**  
14,0 cm, 5<sup>1</sup>/<sub>2</sub>"



**AK-1801-17**  
17,0 cm, 6<sup>3</sup>/<sub>4</sub>"



**AK-1801-18**  
18,0 cm, 7"



**TOENNIS**  
18,0 cm, 7"  
**AK-1802-18**

Nadelhalter mit Hartmetalleinlagen  
Needle Holders with tungsten carbide inserts  
Porta-agujas con bocas de carburo tungsteno  
Portaghi con morsi in carburo di tungsteno



MATHIEU-KOCHER



**AK-1803-14**  
14,0 cm, 5½"



**AK-1803-17**  
17,0 cm, 6¾"

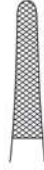

**AK-1803-20**  
20,0 cm, 8"



MATHIEU



**AK-1804-14**  
14,0 cm, 5½"



**AK-1804-17**  
17,0 cm, 6¾"



**AK-1804-20**  
20,0 cm, 8"

**Nadelhalter mit Hartmetalleinlagen**  
**Needle Holders with tungsten carbide inserts**  
**Porta-agujas con bocas de carburo tungsteno**  
**Portaghi con morsi in carburo di tungsteno**



**LICHTENBERG**



**AK-1805-17**  
17,0 cm, 6<sup>3</sup>/<sub>4</sub>"



**AK-1805-20**  
20,0 cm, 8"



**MATHIEU**



**AK-1806-17**  
17,0 cm, 6<sup>3</sup>/<sub>4</sub>"



**AK-1806-20**  
20,0 cm, 8"



**AK-1806-23**  
23,0 cm, 9"

MEDICAL SUPPLY

**Nadelhalter mit Hartmetalleinlagen**  
**Needle Holders with tungsten carbide inserts**  
**Porta-agujas con bocas de carburo tungsteno**  
**Portaghi con morsi in carburo di tungsteno**



**ZWEIFEL**



**LANGENBECK**

**Nadelhalter mit Hartmetalleinlagen**  
**Needle Holders with tungsten carbide inserts**  
**Porta-agujas con bocas de carburo tungsteno**  
**Portaghi con morsi in carburo di tungsteno**

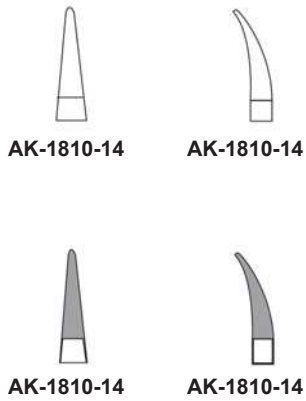

mit Sperre  
with ratchet  
con cremallera  
con cremagliera

**CASTROVIEJO**  
14,5 cm, 5<sup>3</sup>/<sub>4</sub>"

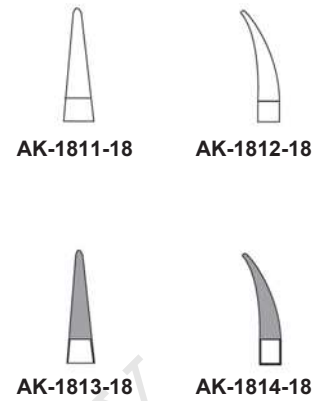

mit Sperre  
with ratchet  
con cremallera  
con cremagliera

**CASTROVIEJO**  
18,0 cm, 7"

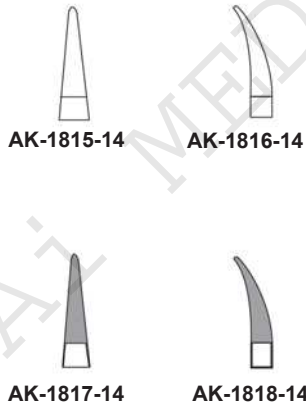

mit Sperre  
with ratchet  
con cremallera  
con cremagliera

**BARRAQUER**  
14,5 cm, 5<sup>3</sup>/<sub>4</sub>"



**HEPP SCHEIDEL**  
18,0 cm, 7"  
AK-1819-18



REVERDIN-Nadeln  
 REVERDIN Needles  
 Aguja de REVERDIN  
 Aghi di REVERDIN



REVERDIN  
 14,0 cm, 5 1/2"



AK-1820-01

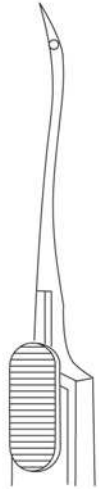

AK-1820-02

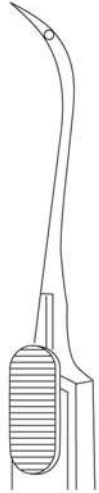

AK-1820-03



AK-1820-04



REVERDIN



19,5 cm, 7 3/4" AK-1821-01 AK-1821-02 AK-1821-03 AK-1821-04  
 22,5 cm, 8 3/4" AK-1822-01 AK-1822-02 AK-1822-03 AK-1822-04

**Unterbindungsnadeln**  
**Ligature Needles**  
**Agujas para ligaduras**  
**Aghi per legatura**

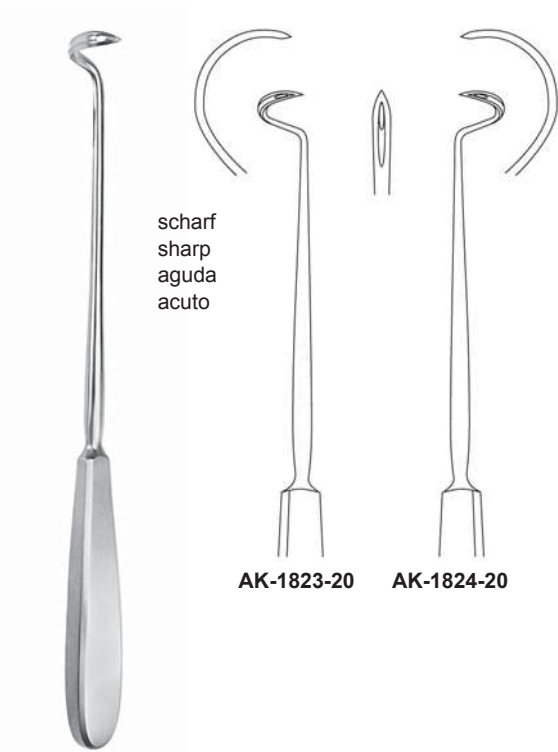

**DESCHAMPS**  
 20,0 cm, 8"

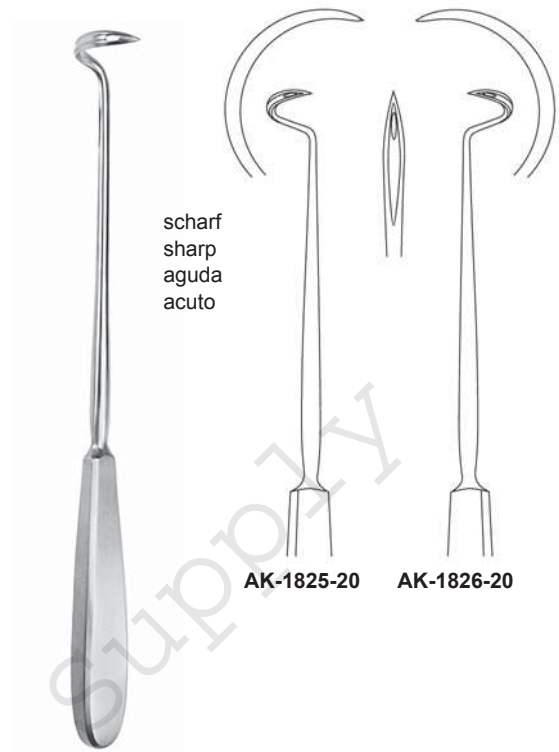

**DESCHAMPS**  
 20,0 cm, 8"

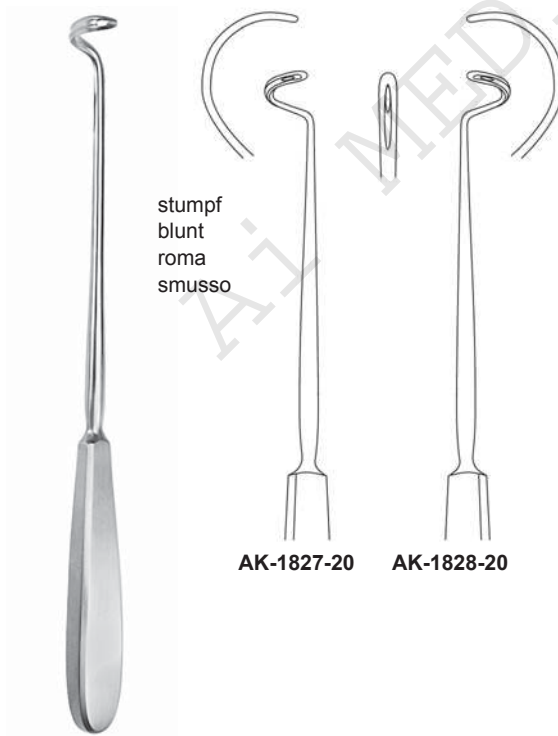

**DESCHAMPS**  
 20,0 cm, 8"

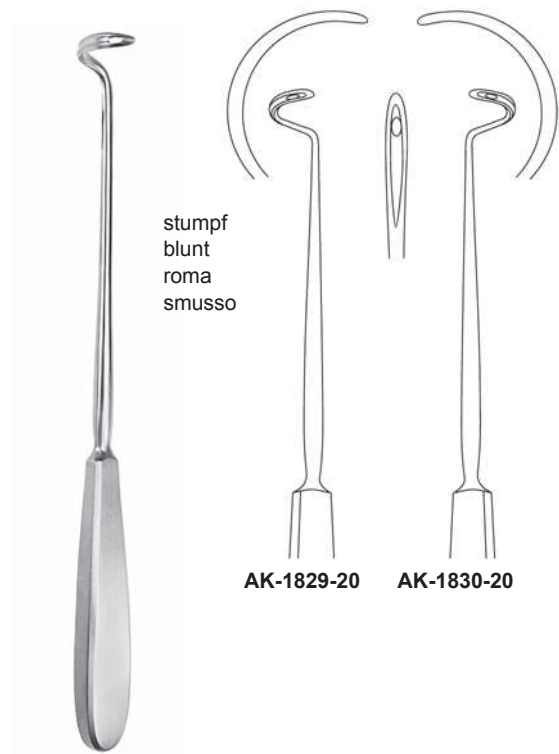

**DESCHAMPS**  
 20,0 cm, 8"

Unterbindungsnadeln  
 Ligature Needles  
 Agujas para ligaduras  
 Aghi per legatura

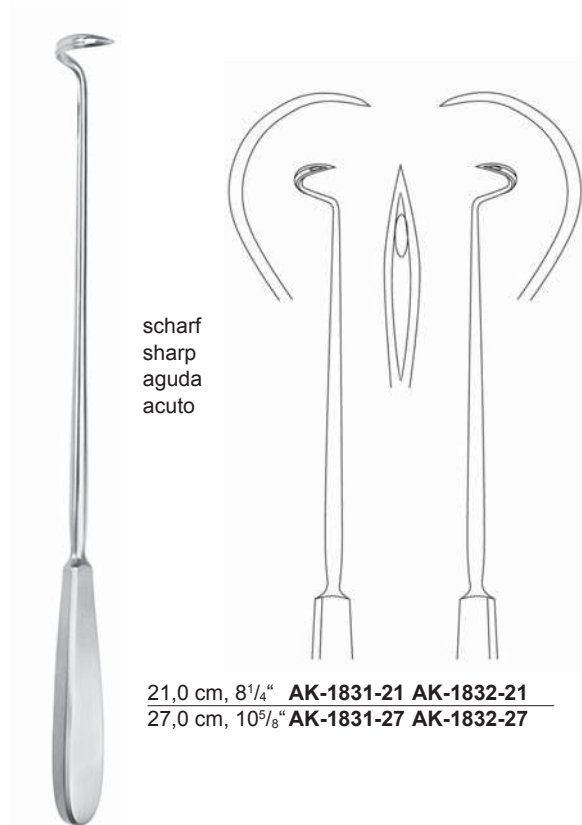

scharf  
 sharp  
 aguda  
 acuto

21,0 cm, 8<sup>1</sup>/<sub>4</sub>" **AK-1831-21 AK-1832-21**  
 27,0 cm, 10<sup>5</sup>/<sub>8</sub>" **AK-1831-27 AK-1832-27**

**DESCHAMPS**

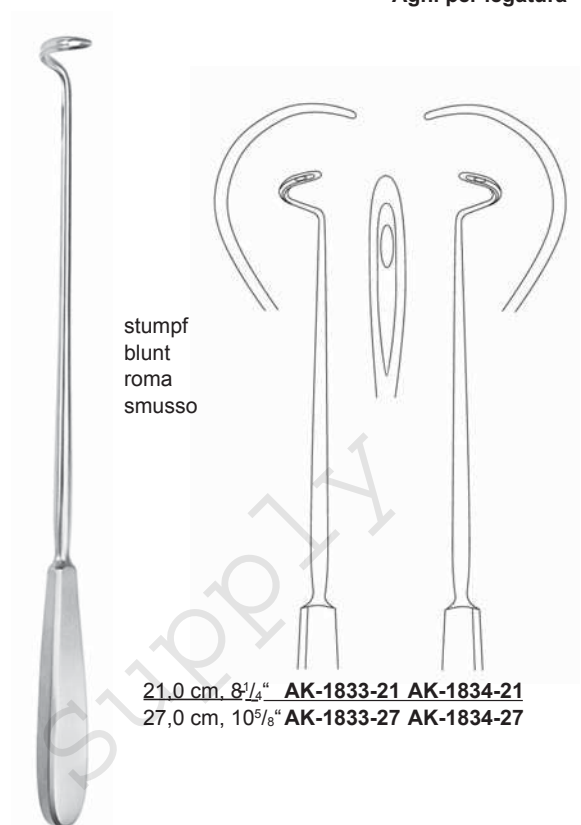

stumpf  
 blunt  
 roma  
 smusso

21,0 cm, 8<sup>1</sup>/<sub>4</sub>" **AK-1833-21 AK-1834-21**  
 27,0 cm, 10<sup>5</sup>/<sub>8</sub>" **AK-1833-27 AK-1834-27**

**DESCHAMPS**



biegsam  
 malleable  
 malleable  
 malleabile

20,0 cm, 8"  
**AK-1835-20**



**COOPER**  
 19,0 cm, 7<sup>1</sup>/<sub>2</sub>"  
**AK-1836-19**



**COOPER**  
 20,0 cm, 8"  
**AK-1837-20**



**SYME**  
 15,0 cm, 6"  
**AK-1838-15**

Unterbindungsnadeln  
Ligature Needles  
Agujas para ligaduras  
Aghi per legatura



**KOCHER**  
19,0 cm, 7 $\frac{1}{2}$ "



**AK-1839-01**



**AK-1839-02**



**AK-1839-03**



**BRUNNER**  
25,0 cm, 9 $\frac{3}{4}$ "  
**AK-1840-25**



**BRUNNER**  
30,0 cm, 11 $\frac{3}{4}$ "



**AK-1841-01**



**AK-1841-02**



**SCHMIEDEN**  
21,0 cm, 8 $\frac{1}{4}$ "  
**AK-1842-21**

Unterbindungsnadeln  
Ligature Needles  
Agujas para ligaduras  
Aghi per legatura



**YOUNG-HRYNTSCHAK**  
24,0 cm, 9½"  
LN-1844-24



AK-1843-01



AK-1843-02



AK-1843-03



**DE LA ROZA**  
12,0 cm, 4¾"  
AK-1845-01



**DE LA ROZA**  
12,0 cm, 4¾"  
AK-1846-02



**JAKOBI**  
14,0 cm, 5½"  
AK-1847-14



**HESSEBERG**  
15,0 cm, 6"  
AK-1848-15



**KRONECKER**  
15,0 cm, 6"  
AK-1849-01

**Unterbindungsnadeln**  
**Ligature Needles**  
**Agujas para ligaduras**  
**Aghi per legatura**



**KRONECKER**  
 15,0 cm, 6"  
**AK-1850-02**



**TRÉLAT**  
 23,0 cm, 9"  
**AK-1851-23**



**CLAUS**  
 23,0 cm, 9"  
**AK-1852-23**



**HURD**  
 21,0 cm, 8 1/4"  
**AK-1853-01**



**HURD**  
 21,0 cm, 8 1/4"  
**AK-1854-02**



**NAGER**  
 24,0 cm, 9 1/2"  
**AK-1855-24**



**CLAUS-EICKEN**  
 23,0 cm, 9"  
**AK-1856-23**



**FALK**  
 24,0 cm, 9 1/2"  
**AK-1857-01**



**FALK**  
 24,0 cm, 9 1/2"  
**AK-1858-02**

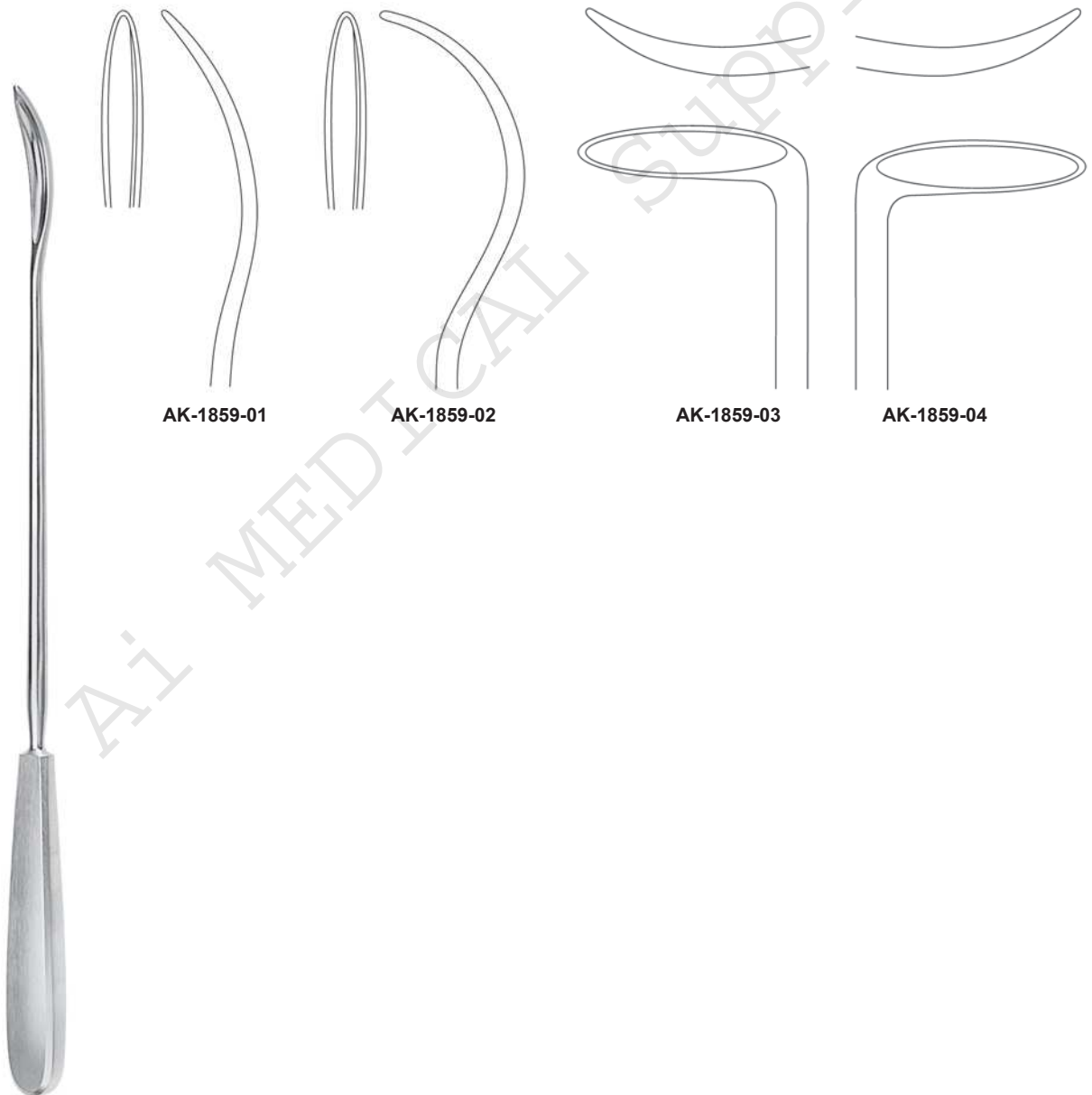

**BRUNNER**  
30,0 cm, 11<sup>3</sup>/<sub>4</sub>"

Führungshohlsonden  
 Ligature Conductors  
 Sondas conductoras  
 Sonde conduttrici



**PAYR**  
 22,0 cm, 8<sup>5</sup>/<sub>8</sub>"  
 AK-1860-22



**PAYR**  
 22,0 cm, 8<sup>5</sup>/<sub>8</sub>"  
 AK-1861-22



mit Loch  
 with hole  
 con foro  
 con ago

**SCHMIEDEN-PAYR**  
 19,0 cm, 7<sup>1</sup>/<sub>2</sub>"  
 AK-1862-19



ohne Loch  
 without hole  
 sin foro  
 senza ago

**SCHMIEDEN**  
 19,0 cm, 7<sup>1</sup>/<sub>2</sub>"  
 AK-1863-19



**KÖNIG**  
 19,5 cm, 7<sup>3</sup>/<sub>4</sub>"  
 AK-1864-03



**KÖNIG**  
 19,5 cm, 7<sup>3</sup>/<sub>4</sub>"  
 AK-1865-05



**KÖNIG**  
 19,5 cm, 7<sup>3</sup>/<sub>4</sub>"  
 AK-1866-07





**KIRSCHNER**



**BRUNNER-FERROZELL**  
 18,0 cm, 7" **AK-1868-18**  
 27,0 cm, 10<sup>5</sup>/<sub>8</sub>" **AK-1868-27**



**KOCHER**

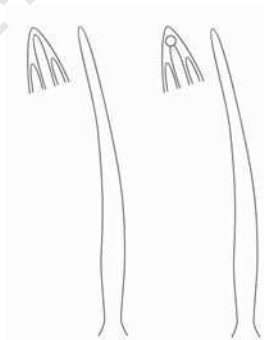

15,0 cm, 6" **AK-1869-15 LN-1870-15**  
 16,0 cm, 6<sup>1</sup>/<sub>4</sub>" **AK-1869-16 LN-1870-16**



18,0 cm, 7"  
**AK-1871-18**

Nahtinstrumente  
 Suture Instruments  
 Instrumentos para sutura  
 Strumenti per sutura



**MOD. WIEN**  
 23,5 cm, 9<sup>1</sup>/<sub>4</sub>"  
 AK-1872-23



**BOZEMANN**  
 21,0 cm, 8<sup>1</sup>/<sub>4</sub>"  
 AK-1873-21



23,0 cm, 9"  
 AK-1874-23



**MICHEL**  
 12,0 cm, 4<sup>3</sup>/<sub>4</sub>"  
 AK-1875-12



**COLLIN**  
 13,0 cm, 5"  
 AK-1876-13



**RICHTER-HEATH**  
 14,0 cm, 5<sup>1</sup>/<sub>2</sub>"  
 AK-1877-14



**WACHENFELDT**  
 12,5 cm, 5"  
 AK-1878-01



**HEGENBARTH**  
 12,5 cm, 5"  
 AK-1879-12



**MICHEL**  
12,0 cm, 4<sup>3</sup>/<sub>4</sub>"  
AK-1880-12



**LANGE**  
10,0 cm, 4"  
AK-1881-10



**CHILDE**  
18,0 cm, 7"  
AK-1882-01



**CHILDE**  
18,0 cm, 7"  
AK-1883-02

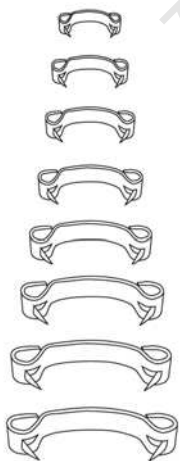

- AK-1884-08 7,5 x 1,75 mm
- AK-1884-11 11,0 x 2,0 mm
- AK-1884-12 12,0 x 3,0 mm
- AK-1884-14 14,0 x 3,0 mm
- AK-1884-16 16,0 x 3,0 mm
- AK-1884-18 18,0 x 3,0 mm
- AK-1884-20 20,0 x 3,0 mm
- AK-1884-22 22,0 x 3,0 mm

**MICHEL**



**CLIP-SET**  
056-558-00

bestehend aus, consisting of, compuesto de, composto da

- 1 x AK-1885-12
- 1 x AK-1886-12
- 50 x AK-1887-14
- 1 x AK-1888-01 (Etui)

Ai MEDICAL Supply

**Wundhaken**  
**Retractors**  
**Separadores**  
**Divaricatori**



**Dura- und Hauthäkchen**  
**Dura and Skin Retractors**  
**Gancho para piel y dura-madre**  
**Unico per pelle e dura-madre**



Fig. 1  
**AK-1889-01**

Fig. 2  
**AK-1890-02**

**GILLIES**  
 18,0 cm, 7"



**KILNER**  
 15,0 cm, 6"  
**AK-1891-15**



**FRAZIER**  
 13,0 cm, 5"  
**AK-1892-13**



**O'CONNOR**  
 16,0 cm, 6 1/4"  
**AK-1893-16**



Fig. 1  
**AK-1894-01**

Fig. 2  
**AK-1895-02**

Fig. 3  
**AK-1895-03**

**KLEINERT-KUTZ**  
 16,0 cm, 6 1/4"



**JOSEPH**  
 16,0 cm, 6 1/4"  
**AK-1898-16**



**GRAEFE**  
 16,0 cm, 6 1/4"



Fig. 1  
**AK-1896-01**



Fig. 2  
**AK-1897-02**

**Dura- und Hauthäkchen**  
**Dura and Skin Retractors**  
**Gancho para piel y dura-madre**  
**Unico per pelle e dura-madre**



16,0 cm, 6 1/4"

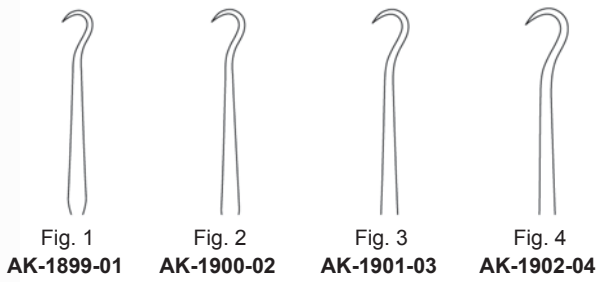

Fig. 1 **AK-1899-01**  
 Fig. 2 **AK-1900-02**  
 Fig. 3 **AK-1901-03**  
 Fig. 4 **AK-1902-04**



**GUTHRIE**  
 16,0 cm, 6 1/4"



Fig. 1  
**AK-1903-01**



Fig. 2  
**AK-1904-02**



**JOSEPH**  
 16,0 cm, 6 1/4"

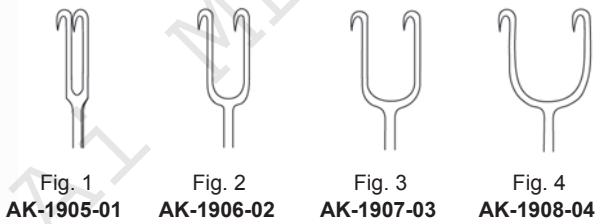
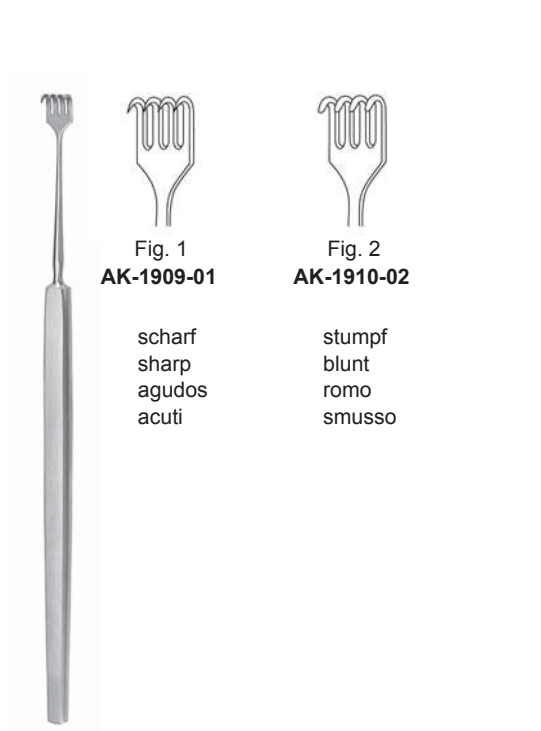

Fig. 1 **AK-1905-01**  
 Fig. 2 **AK-1906-02**  
 Fig. 3 **AK-1907-03**  
 Fig. 4 **AK-1908-04**

MEDICAL SUPPLY

Wundhaken  
Retractors  
Separadores  
Divaricatori



**KNAPP**  
13,0 cm, 5"



scharf  
sharp  
agudos  
acuti



stumpf  
blunt  
romo  
smusso



16,0 cm, 6 1/4"

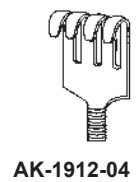
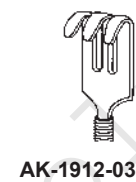

flexibel · flexible · flexibles · flessibili



16,0 cm, 6 1/4"



scharf  
sharp  
agudos  
acuti

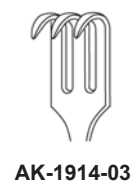

halbscharf  
semi-sharp  
semi-agudos  
semi-acuti



stumpf  
blunt  
romo  
smusso



**Wundhaken  
Retractors  
Separadores  
Divaricatori**



16,0 cm, 6 1/4"

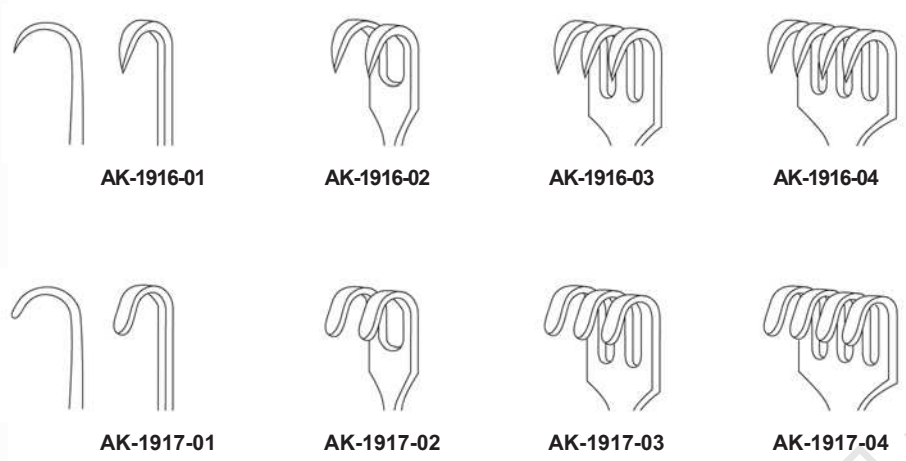

scharf  
sharp  
agudos  
acuti

stumpf  
blunt  
romo  
smusso



**CUSHING**  
19,0 cm, 7 1/2"

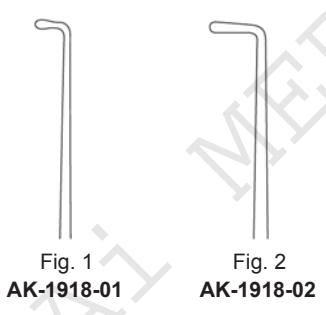

**LANGENBECK-GREEN**  
16,0 cm, 6 1/4"

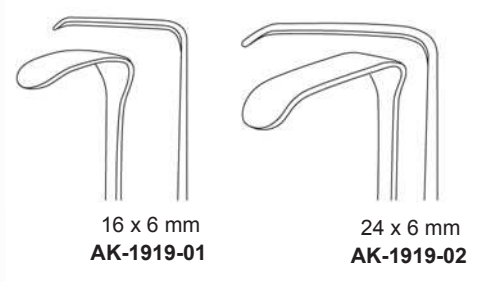

MEDICAL SUPPLY

**Wundhaken  
Retractors  
Separadores  
Divaricatori**



**MEYERDING**  
18,0 cm, 7"



18 x 7 mm  
**AK-1920-01**



16 x 5 mm  
**AK-1920-02**



7 x 4 mm  
**AK-1920-03**



14 x 8 mm  
**AK-1923-16**



10 x 3 mm  
**AK-1921-04**



7 x 4 mm  
**AK-1921-05**



4 x 10 mm  
**AK-1921-06**



16,0 cm, 6 1/4"



**SENN-GREEN**  
15,0 cm, 6"



10 x 6 mm  
**AK-1924-10**

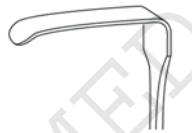

20 x 6 mm  
**AK-1924-20**



**MINI-LANGENBECK**  
16,0 cm, 6 1/4"



10 x 6 mm  
**AK-1925-01**



17 x 5 mm  
**AK-1925-02**



20 x 6 mm  
**AK-1926-03**

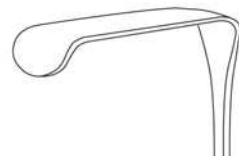

22 x 8 mm  
**AK-1926-04**



**RAGNELL-DAVIS**  
14,0 cm, 5 1/2"  
AK-1927-14



**RAGNELL**  
15,0 cm, 6"  
AK-1928-15

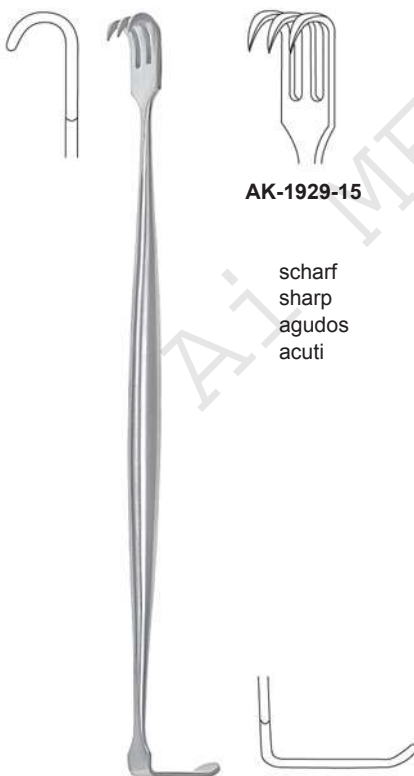

**BABY SENN-MILLER**  
15,0 cm, 6"

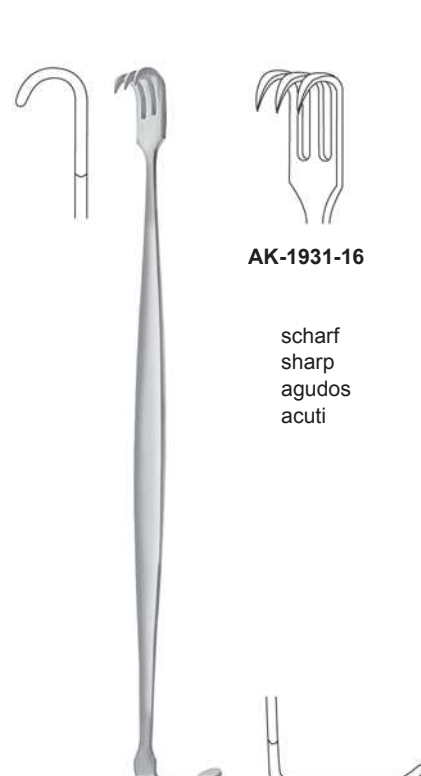

**SENN-MILLER**  
16,0 cm, 6 1/4"

AK-1929-15

scharf  
sharp  
agudos  
acuti

AK-1930-15

stumpf  
blunt  
romo  
smusso

AK-1931-16

scharf  
sharp  
agudos  
acuti

AK-1932-16

stumpf  
blunt  
romo  
smusso

Wundhaken  
 Retractors  
 Separadores  
 Divaricatori

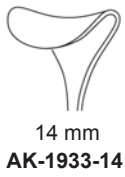

**DESMARRES**  
 13,0 cm, 5"

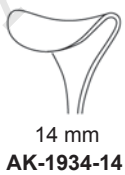
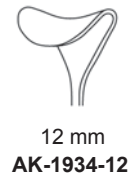

**DESMARRES**  
 16,0 cm, 6 1/4"

MEDICAL SUPPLY



8 mm  
AK-1935-08



10 mm  
AK-1935-10

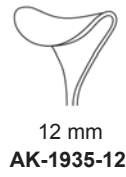

12 mm  
AK-1935-12

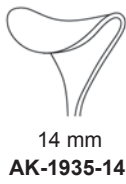

14 mm  
AK-1935-14



16 mm  
AK-1935-16



18 mm  
AK-1935-18

**CUSHING**  
20,0 cm, 8"



8 mm  
AK-1936-08

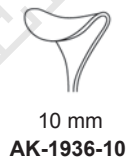

10 mm  
AK-1936-10

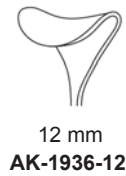

12 mm  
AK-1936-12

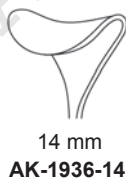

14 mm  
AK-1936-14



16 mm  
AK-1936-16



18 mm  
AK-1936-18

**CUSHING**  
24,0 cm, 9 1/2"

Wundhaken  
Retractors  
Separadores  
Divaricatori



**GIL-VERNET**  
24,0 cm, 9½"



8 mm  
**AK-1937-08**



11 mm  
**AK-1937-11**



13 mm  
**AK-1937-13**



17 mm  
**AK-1937-17**



20 mm  
**AK-1937-20**



23 mm  
**AK-1937-23**



**GIL-VERNET**  
24,0 cm, 9½"



8 mm  
**AK-1938-08**



11 mm  
**AK-1938-11**



13 mm  
**AK-1938-13**



17 mm  
**AK-1938-17**



20 mm  
**AK-1938-20**



23 mm  
**AK-1938-23**



**ROUX**  
**AK-1939-12**

- Fig. 1 24 x 20 mm
- Fig. 2 29 x 26 mm
- Fig. 3 33 x 29 mm
- Fig. 4 29 x 24 mm

Satz, Fig. 1-3  
Set, fig. 1-3  
Juego, fig. 1-3  
Serie, fig. 1-3

- Fig. 1 30 x 28 mm
- Fig. 2 36 x 36 mm
- Fig. 3 38 x 43 mm
- Fig. 4 45 x 28 mm

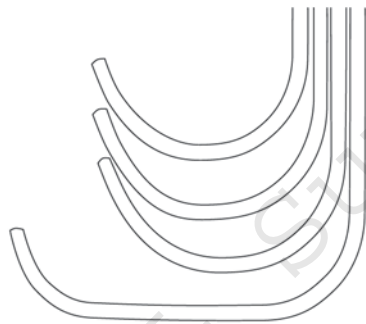
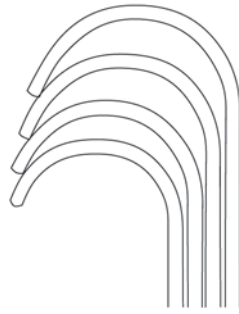

- |          |  |                   |
|----------|--|-------------------|
| Fig. 1-3 | 17,0 cm, 6 <sup>3</sup> / <sub>4</sub> " | <b>AK-1940-00</b> |
| Fig. 1   | 14,0 cm, 5 <sup>1</sup> / <sub>2</sub> " | <b>AK-1940-01</b> |
| Fig. 2   | 15,0 cm, 6"                              | <b>AK-1940-02</b> |
| Fig. 3   | 17,0 cm, 6 <sup>3</sup> / <sub>4</sub> " | <b>AK-1940-03</b> |
| Fig. 4   | 18,0 cm, 7"                              | <b>AK-1940-04</b> |



**FARABEUF**  
12,0 cm, 4<sup>3</sup>/<sub>4</sub>"  
**AK-1941-12**

- Fig. 2 30 x 10 mm
- Fig. 1 26 x 10 mm

- Fig. 1 30 x 13 mm
- Fig. 2 34 x 13 mm

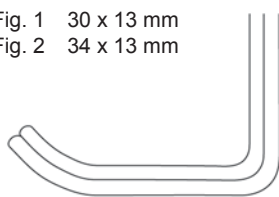
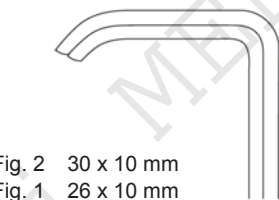

**FARABEUF**  
15,0 cm, 5<sup>3</sup>/<sub>4</sub>"  
**AK-1941-15**

- Fig. 2 23 x 16 mm
- Fig. 1 27 x 16 mm

- Fig. 1 26 x 16 mm
- Fig. 2 30 x 16 mm

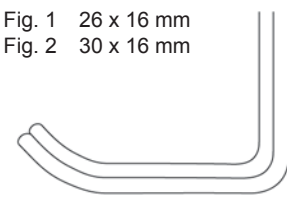
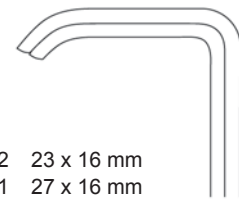

Wundhaken  
Retractors  
Separadores  
Divaricatori



**MINI-ROUX**  
14,0 cm, 5½"  
AK-1942-06



**BABY-ROUX**  
13,0 cm, 5"  
AK-1943-13

18 x 17 mm

24 x 21 mm



**PARKER**  
13,5 cm, 5¾"  
AK-1944-00

Fig. 2 22 x 15 mm  
Fig. 1 19 x 15 mm

Fig. 1 19 x 15 mm  
Fig. 2 22 x 15 mm



**CZERNY**  
17,5 cm, 7"  
AK-1945-00



36 mm



38 x 42 mm



**MATHIEU**  
20,0 cm, 8"  
AK-1946-00

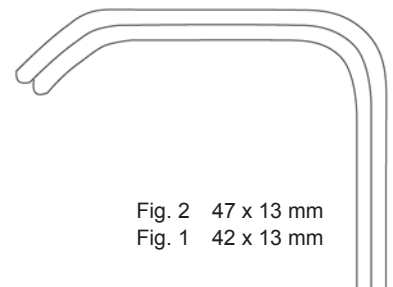

Fig. 2 47 x 13 mm  
Fig. 1 42 x 13 mm

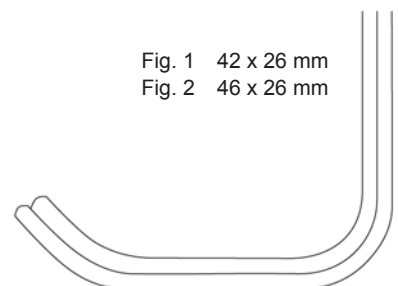
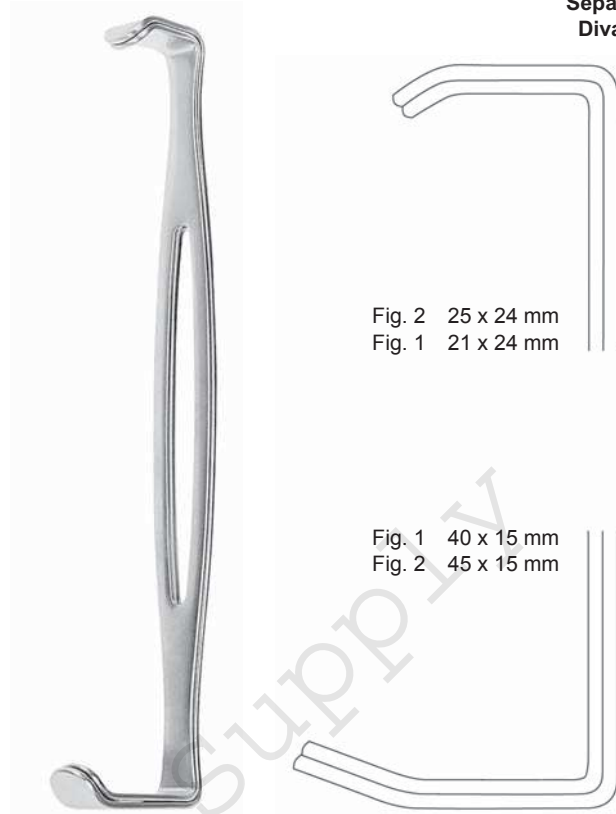

Fig. 1 42 x 26 mm  
Fig. 2 46 x 26 mm





**GOELET**  
19,0 cm, 7½"  
AK-1947-19



**PARKER-LANGENBECK**  
21,0 cm, 8¼"  
AK-1948-00



**CANNY RYAL**

16 mm	19,0 cm, 7½"	<b>AK-1949-16</b>
20 mm	19,0 cm, 7½"	<b>AK-1949-20</b>
25 mm	20,0 cm, 8"	<b>AK-1949-25</b>

Wundhaken  
Retractors  
Separadores  
Divaricatori



**VOLKMANN**  
21,5 cm, 8½"



**AK-1950-01**



9 x 8 mm  
**AK-1950-02**



9 x 13 mm  
**AK-1950-03**



9 x 19 mm  
**AK-1950-04**



9 x 29 mm  
**AK-1950-06**

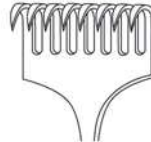

9 x 40 mm  
**AK-1950-08**

scharf  
sharp  
agudos  
acuti



**AK-1951-01**



9 x 8 mm  
**AK-1951-02**



9 x 13 mm  
**AK-1951-03**



9 x 19 mm  
**AK-1951-04**



9 x 29 mm  
**AK-1951-06**

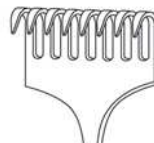

9 x 40 mm  
**AK-1951-08**

halbscharf  
semi-sharp  
semi-agudos  
semi-acuti



**VOLKMANN**  
21,5 cm, 8½"



**VOLKMANN**  
21,5 cm, 8½"



**AK-1952-01**



9 x 8 mm  
**AK-1952-02**



9 x 13 mm  
**AK-1952-03**



9 x 19 mm  
**AK-1952-04**



9 x 29 mm  
**AK-1952-06**

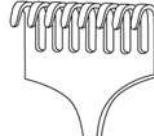

9 x 40 mm  
**AK-1952-08**

stumpf  
blunt  
romo  
smusso



**KOCHER**  
22,0 cm, 8⅝"



**AK-1953-01**



9 x 8 mm  
**AK-1953-02**



15 x 15 mm  
**AK-1953-03**



15 x 20 mm  
**AK-1953-04**



15 x 30 mm  
**AK-1953-06**

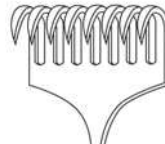

15 x 40 mm  
**AK-1953-08**

scharf  
sharp  
agudos  
acuti

Wundhaken  
Retractors  
Separadores  
Divaricatori



**KOCHER**  
22,0 cm, 8<sup>5</sup>/<sub>8</sub>"

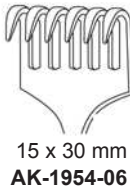
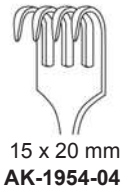
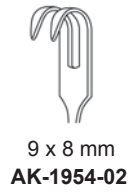

halbscharf  
semi-sharp  
semi-agudos  
semi-acuti



**KOCHER**  
22,0 cm, 8<sup>5</sup>/<sub>8</sub>"

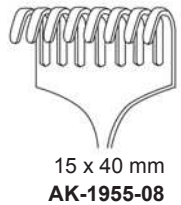
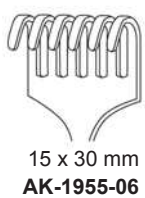
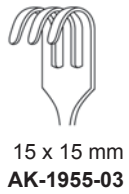
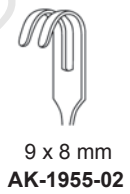

stumpf  
blunt  
romo  
smusso

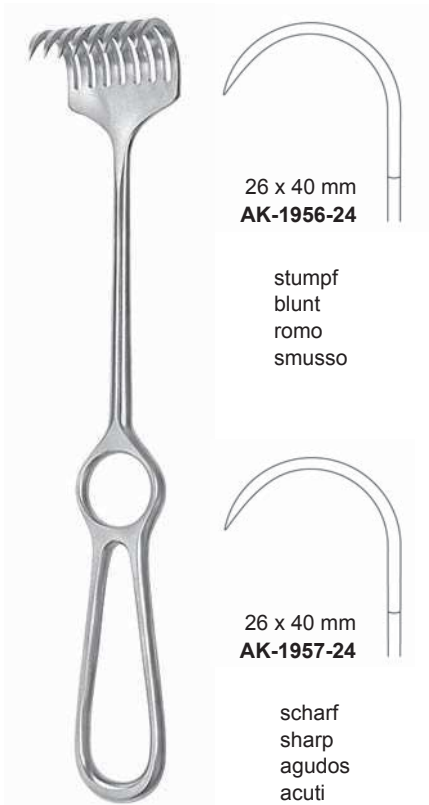

26 x 40 mm  
**AK-1956-24**

stumpf  
blunt  
romo  
smusso

26 x 40 mm  
**AK-1957-24**

scharf  
sharp  
agudos  
acuti

**KOERTE**  
24,0 cm, 9 1/2"



55 x 20 mm  
**AK-1956-55**

60 x 20 mm  
**AK-1958-60**

63 x 20 mm  
**AK-1959-63**

**LANGENBECK**  
21,0 cm, 8 1/4"



**ISRAEL**  
25,0 cm, 9 3/4"

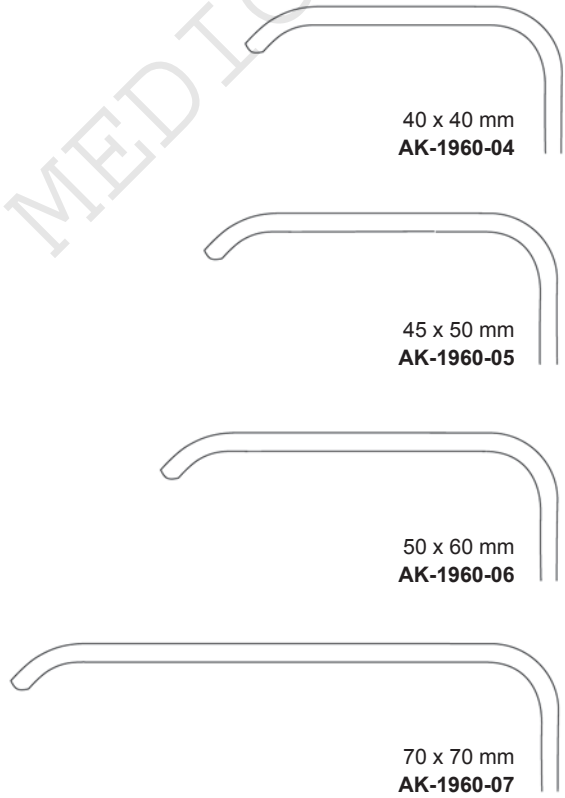

40 x 40 mm  
**AK-1960-04**

4 Tähne  
4 teeth  
4 dientes  
4 denti

45 x 50 mm  
**AK-1960-05**

5 Tähne  
5 teeth  
5 dientes  
5 denti

50 x 60 mm  
**AK-1960-06**

6 Tähne  
6 teeth  
6 dientes  
6 denti

70 x 70 mm  
**AK-1960-07**

6 Tähne  
6 teeth  
6 dientes  
6 denti

**Wundhaken  
Retractors  
Separadores  
Divaricatori**



**LANGENBECK**  
22,0 cm, 8<sup>5</sup>/<sub>8</sub>"

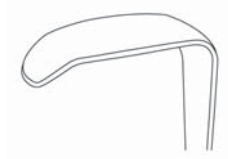

30 x 11 mm  
**AK-1961-30**



30 x 14 mm  
**AK-1961-31**



30 x 16 mm  
**AK-1961-32**

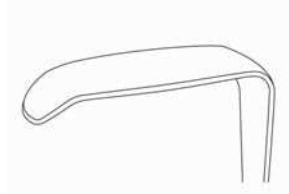

40 x 11 mm  
**AK-1961-40**

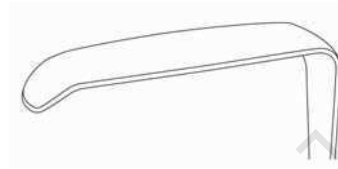

50 x 11 mm  
**AK-1961-50**



**LANGENBECK**  
22,0 cm, 8<sup>5</sup>/<sub>8</sub>"



30 x 11 mm  
**AK-1962-30**



30 x 14 mm  
**AK-1962-31**



30 x 16 mm  
**AK-1962-32**

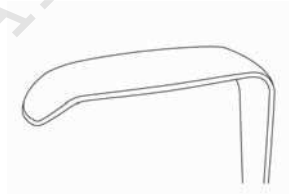

40 x 11 mm  
**AK-1962-40**

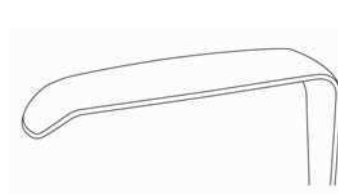

50 x 11 mm  
**AK-1962-50**



**KOCHER-LANGENBECK**  
21,5 cm, 8½"



22 x 6 mm  
**AK-1963-22**



25 x 6 mm  
**AK-1963-25**



25 x 8 mm  
**AK-1963-26**



35 x 8 mm  
**AK-1963-35**



35 x 11 mm  
**AK-1963-36**



35 x 15 mm  
**AK-1963-37**



40 x 11 mm  
**AK-1963-40**



70 x 15 mm  
**AK-1963-70**



80 x 12 mm  
**AK-1963-80**



80 x 15 mm  
**AK-1963-85**



22 x 6 mm  
**AK-1963-22**

Wundhaken  
 Retractors  
 Separadores  
 Divaricatori



**KOCHER**  
 23,0 cm, 9"

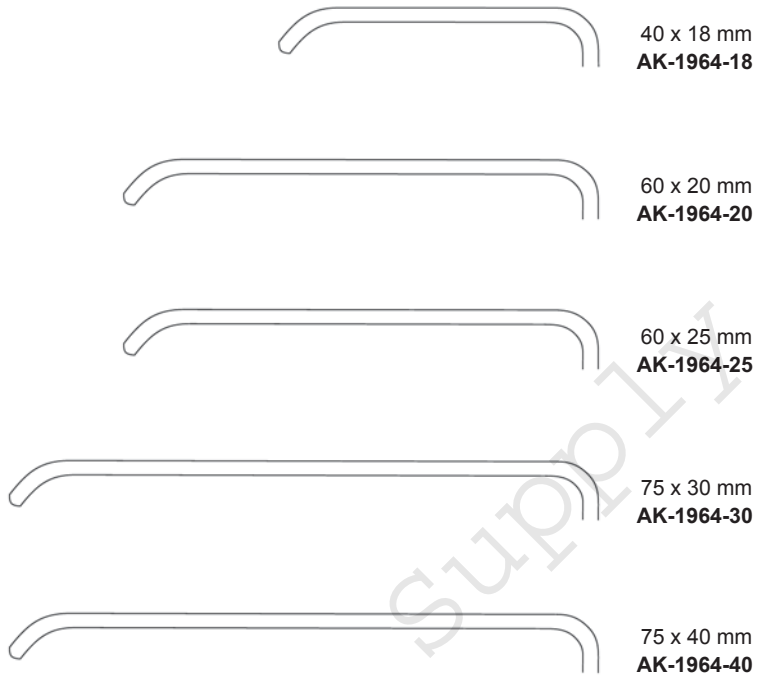

**SAUERBRUCH**  
 22,5 cm, 8<sup>3</sup>/<sub>4</sub>"

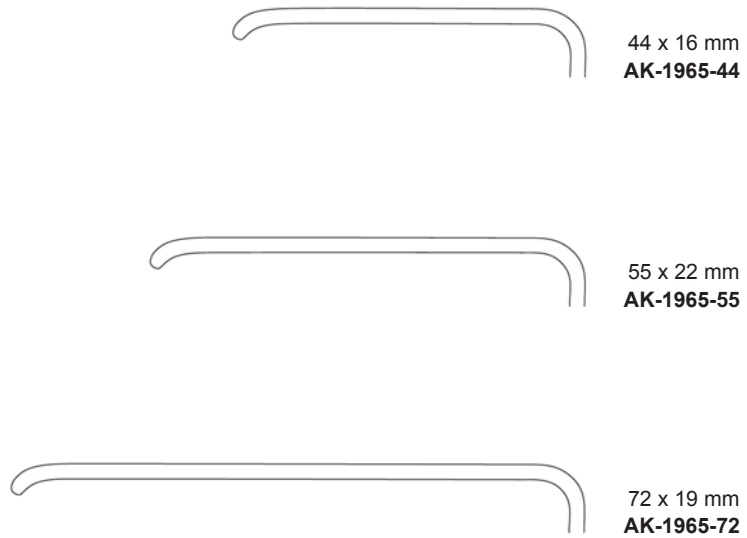





**MIDDELDORPF**



21,5 cm, 8½"  
14 x 17 mm  
**AK-1966-01**

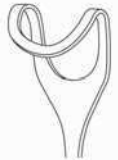

22,0 cm, 8⅝"  
20 x 22 mm  
**AK-1966-02**



23,5 cm, 9¼"  
26 x 30 mm  
**AK-1966-03**



**MIDDELDORPF**



21,5 cm, 8½"  
14 x 17 mm  
**AK-1967-01**



22,0 cm, 8⅝"  
20 x 22 mm  
**AK-1967-02**



23,5 cm, 9¼"  
26 x 30 mm  
**AK-1967-03**



**RICHARDSON (KELLY)**  
24,0 cm, 9½"



**AK-1968-01**



9 x 8 mm  
**AK-1968-02**



15 x 15 mm  
**AK-1968-03**

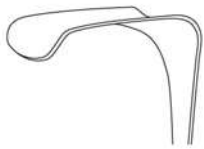

15 x 20 mm  
**AK-1968-04**

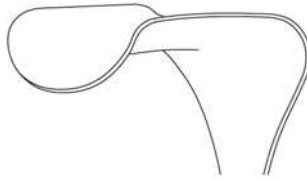

15 x 30 mm  
**AK-1968-06**

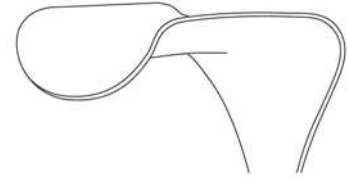

15 x 40 mm  
**AK-1968-08**

**Wundhaken  
Retractors  
Separadores  
Divaricatori**

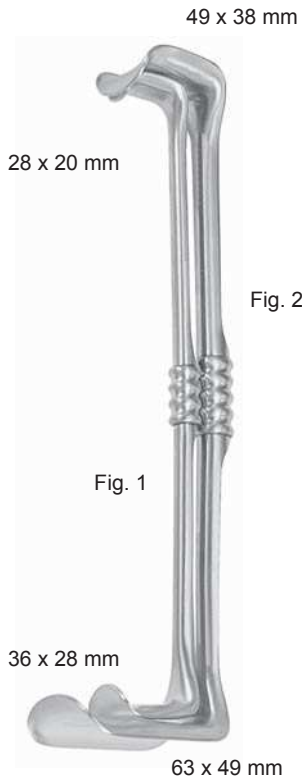

Fig. 1+2 28,0 cm, 11"	<b>AK-1969-00</b>
Fig. 1 26,0 cm, 10 <sup>1</sup> / <sub>4</sub> "	<b>AK-1969-01</b>
Fig. 2 28,0 cm, 11"	<b>AK-1969-02</b>

**RICHARDSON-EASTMAN**



40 x 45 mm	<b>AK-1970-01</b>
45 x 50 mm	<b>AK-1970-02</b>
55 x 70 mm	<b>AK-1970-03</b>

**MIDDELDORPF**  
25,5 cm, 10"



**FRITSCH**  
24,0 cm, 9<sup>1</sup>/<sub>2</sub>"



**DOYEN**  
25,0 cm, 10"  
**AK-1972-86**



**DOYEN-STILLE**  
22,0 cm, 8<sup>5</sup>/<sub>8</sub>"

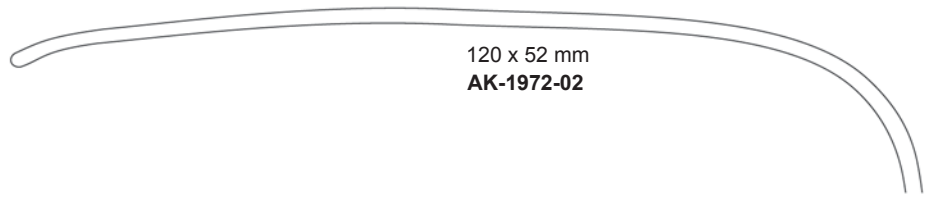

120 x 52 mm  
**AK-1972-02**

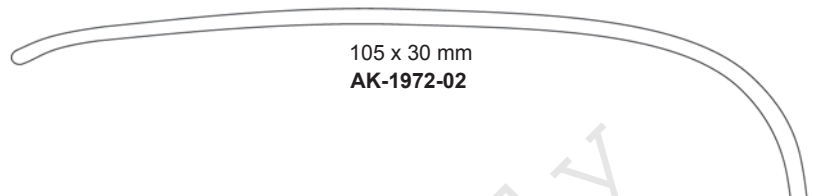

105 x 30 mm  
**AK-1972-02**

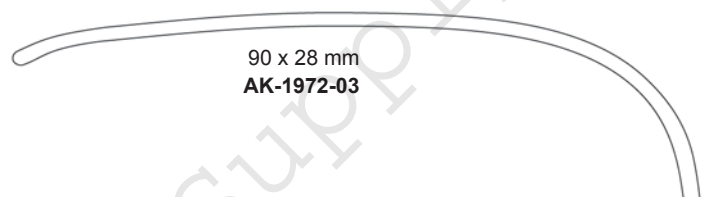

90 x 28 mm  
**AK-1972-03**

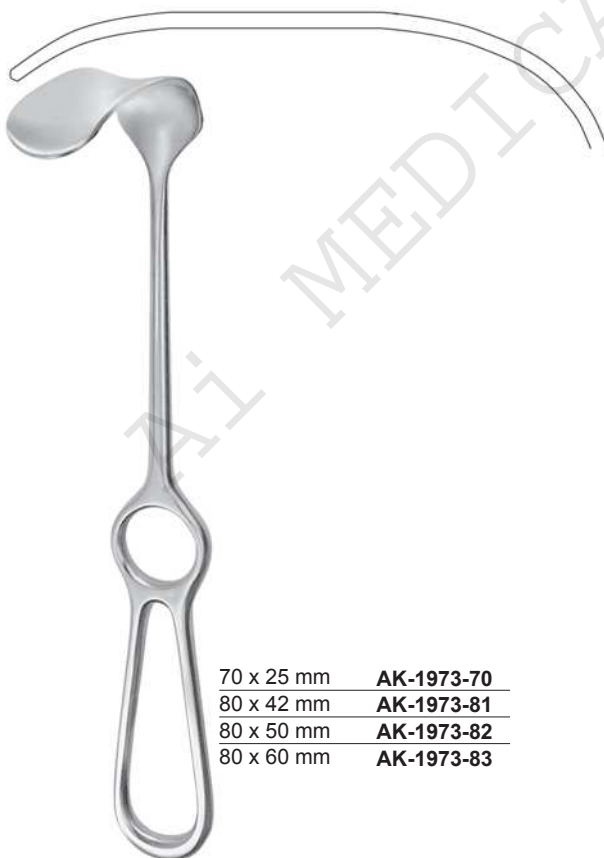

**KOCHER**  
25,0 cm, 10"

- |            |                   |
|------------|-------------------|
| 70 x 25 mm | <b>AK-1973-70</b> |
| 80 x 42 mm | <b>AK-1973-81</b> |
| 80 x 50 mm | <b>AK-1973-82</b> |
| 80 x 60 mm | <b>AK-1973-83</b> |



**LAHEY**  
19,0 cm, 7<sup>1</sup>/<sub>2</sub>"  
**AK-1974-19**

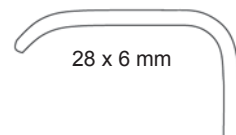

28 x 6 mm

Wundhaken  
Retractors  
Separadores  
Divaricatori

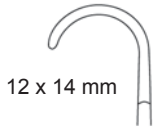

12 x 14 mm

**LITTLE**  
20,0 cm, 8"  
**AK-1976-20**



115 x 22 mm **AK-1975-01**  
115 x 27 mm **AK-1975-02**

**SIMON**  
28,0 cm, 11"



160 x 38 mm **AK-1977-61**  
160 x 57 mm **AK-1977-62**  
190 x 38 mm **AK-1977-91**  
190 x 57 mm **AK-1977-92**

**KELLY**  
27,0 cm, 10 1/2"



85 x 35 mm **AK-1978-01**  
 120 x 50 mm **AK-1978-02**  
 155 x 50 mm **AK-1978-03**

**MIKULICZ**  
26,0 cm, 10<sup>1</sup>/<sub>4</sub>"



90 x 50 mm

**MIKULICZ**  
26,0 cm, 10<sup>1</sup>/<sub>4</sub>"  
**AK-1980-90**



70 x 38 mm **AK-1979-38**  
 70 x 50 mm **AK-1979-51**

**MORRIS**  
24,5 cm, 9<sup>5</sup>/<sub>8</sub>"

Wundhaken  
Retractors  
Separadores  
Divaricatori



127 x 40 mm **AK-1982-40**  
127 x 62 mm **AK-1982-62**

**HARRINGTON**  
32,0 cm, 12½"



82 x 22 mm **AK-1981-01**  
108 x 43 mm **AK-1981-02**  
115x 65 mm **AK-1981-03**

**CORYKKOS**  
24,0 cm, 9½"



**ZENKER**

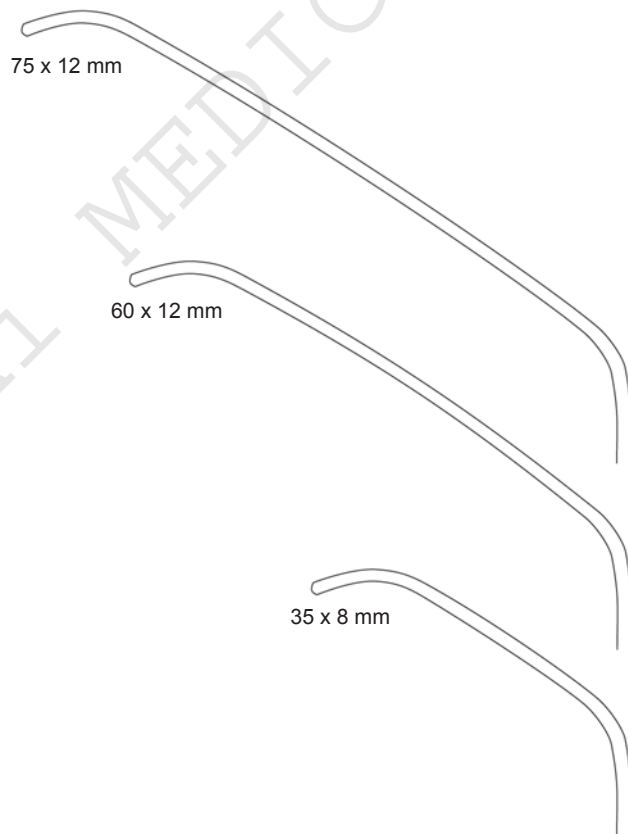

75 x 12 mm

60 x 12 mm

35 x 8 mm

25,0 cm, 9¾"  
**AK-1983-25**

26,0 cm, 10¼"  
**AK-1983-26**

27,5 cm, 10¾"  
**AK-1983-27**



**MEYERDING**  
22,5 cm, 8¾"

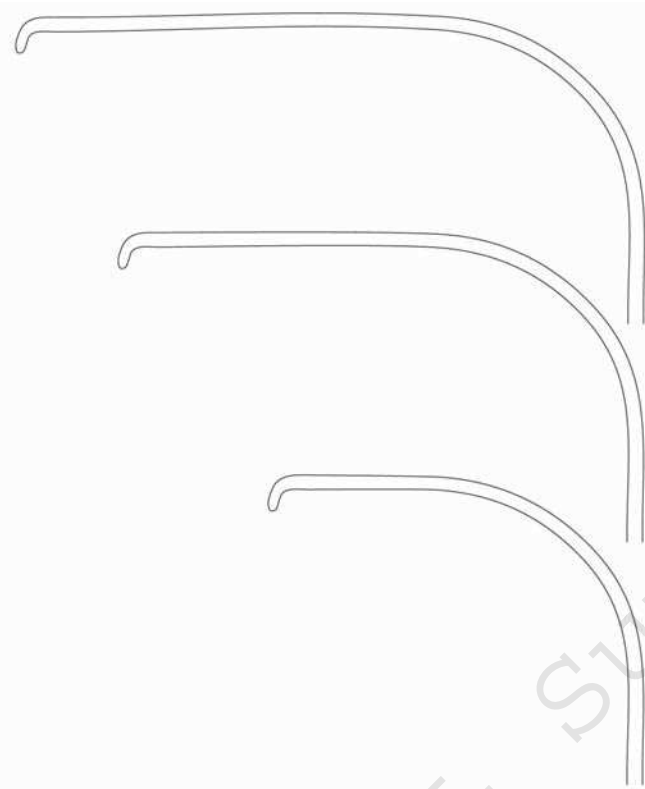

90 x 50 mm  
**AK-1984-50**

75 x 25 mm  
**AK-1984-25**

50 x 16 mm  
**AK-1984-16**



**BRUNNER**  
25,0 cm, 10"

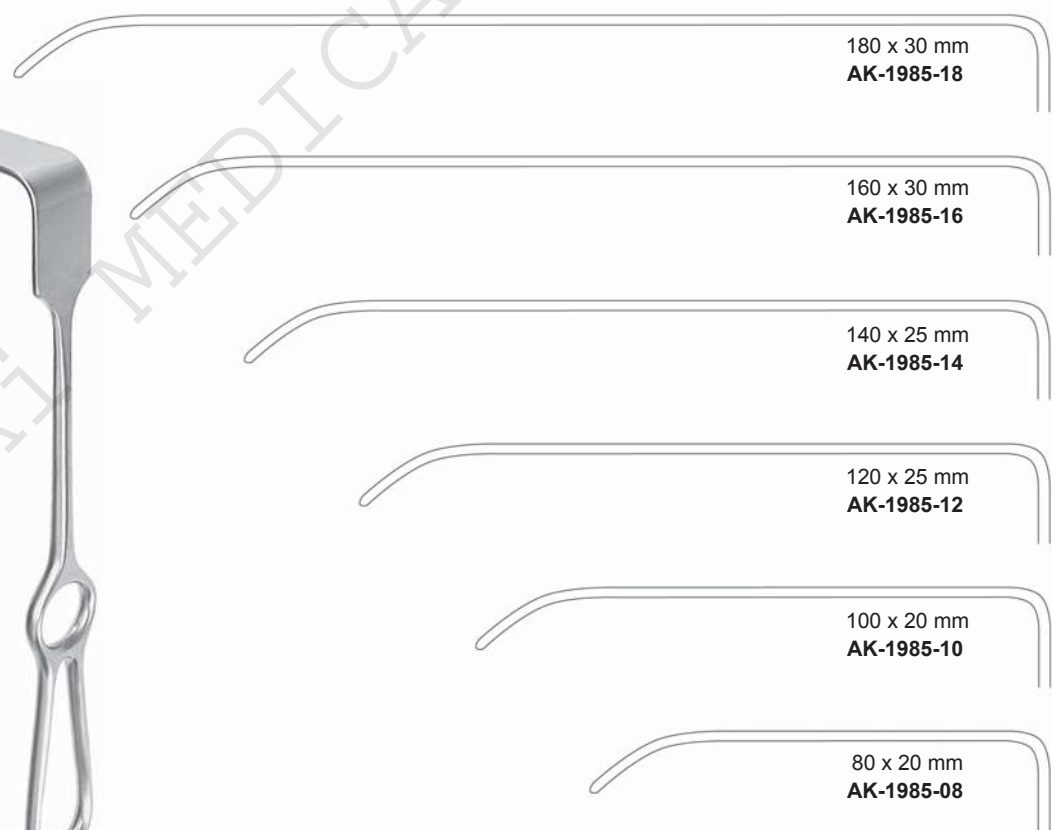

180 x 30 mm  
**AK-1985-18**

160 x 30 mm  
**AK-1985-16**

140 x 25 mm  
**AK-1985-14**

120 x 25 mm  
**AK-1985-12**

100 x 20 mm  
**AK-1985-10**

80 x 20 mm  
**AK-1985-08**

Wundhaken  
Retractors  
Separadores  
Divaricatori



**BRUNNER**  
25,0 cm, 10"



180 x 30 mm  
**AK-1986-18**

160 x 30 mm  
**AK-1986-16**

140 x 25 mm  
**AK-1986-14**

120 x 25 mm  
**AK-1986-12**

100 x 20 mm  
**AK-1986-10**

80 x 20 mm  
**AK-1986-08**



19 mm

**DEAVER**  
18,0 cm, 7"  
**AK-1987-18**



22 mm

**DEAVER**  
21,5 cm, 8 1/2"  
**AK-1987-22**

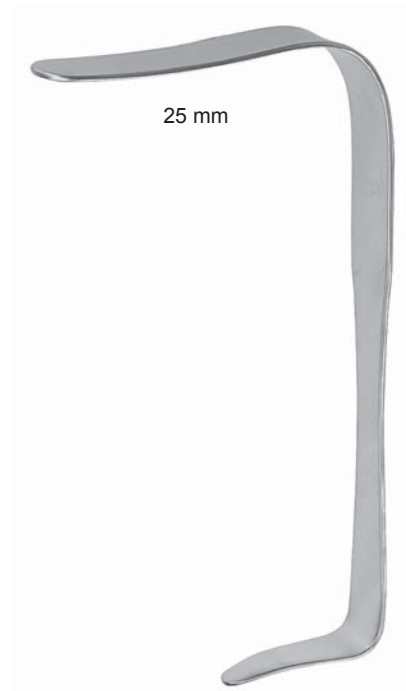

25 mm

**DEAVER**  
23,0 cm, 9"  
**AK-1987-23**





**DEAVER**  
30,0 cm, 11<sup>3</sup>/<sub>4</sub>"  
**AK-1987-30**



**DEAVER**  
33,0 cm, 13"  
**AK-1987-33**



**DEAVER**  
36,0 cm, 14<sup>1</sup>/<sub>8</sub>"  
**AK-1987-36**

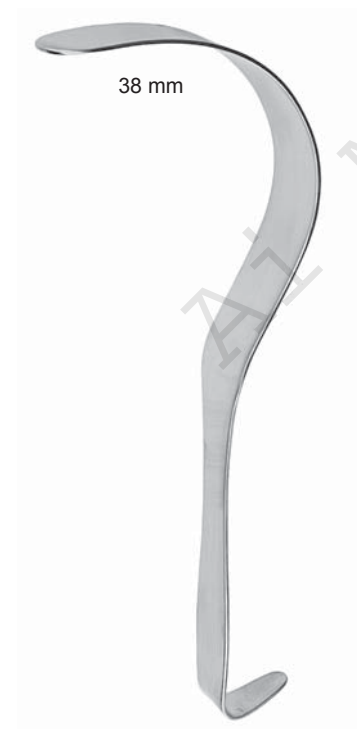

**DEAVER**  
30,0 cm, 11<sup>3</sup>/<sub>4</sub>"  
**AK-1987-38**



**DEAVER**  
30,0 cm, 11<sup>3</sup>/<sub>4</sub>"  
**AK-1987-50**



**DEAVER**  
30,0 cm, 11<sup>3</sup>/<sub>4</sub>"  
**AK-1987-75**

**Wundhaken  
Retractors  
Separadores  
Divaricatori**



25 mm	<b>AK-1988-25</b>
38 mm	<b>AK-1988-38</b>
50 mm	<b>AK-1988-50</b>
75 mm	<b>AK-1988-75</b>

**DEAVER GRIP**  
30,0 cm, 11<sup>3</sup>/<sub>4</sub>"



**ALLISON**

40 mm	30,0 cm, 11 <sup>3</sup> / <sub>4</sub> "	<b>AK-1989-30</b>
54 mm	32,0 cm, 12 <sup>1</sup> / <sub>2</sub> "	<b>AK-1989-32</b>



**DAVIDSON**

75 x 50 mm	16,0 cm, 6 <sup>2</sup> / <sub>3</sub> "	<b>AK-1990-50</b>
75 x 90 mm	16,0 cm, 6 <sup>1</sup> / <sub>4</sub> "	<b>AK-1990-90</b>



**ST MARKS**

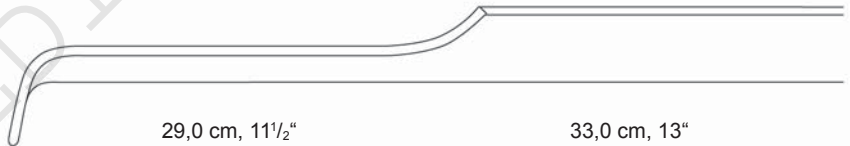

29,0 cm, 11<sup>1</sup>/<sub>2</sub>"  
130 x 60 mm  
**AK-1991-01**

33,0 cm, 13"  
180 x 60 mm  
**AK-1991-02**

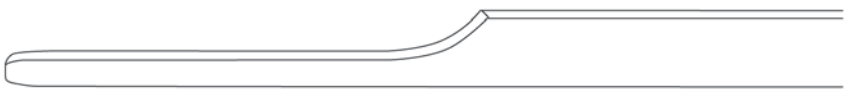

29,0 cm, 11<sup>1</sup>/<sub>2</sub>"  
130 x 60 mm  
**AK-1992-01**

33,0 cm, 13"  
180 x 60 mm  
**AK-1992-02**

**Wundspreizer**  
**Self-Retaining Retractors**  
**Separadores con retenida automática**  
**Divaricatori autostatici**

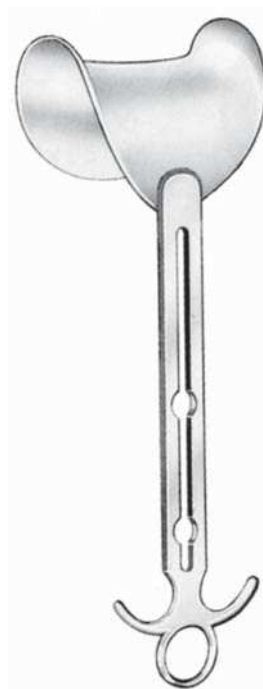

**Wundspreizer**  
**Self-Retaining Retractors**  
**Separadores con retenida automática**  
**Divaricatori autostatici**

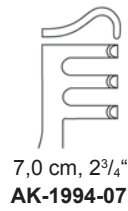

**FINSEN**

scharf  
 sharp  
 agudos  
 acuti

stumpf  
 blunt  
 romo  
 smusso



**JANSEN**  
 10,0 cm, 4"



**ALM**

scharf      halbscharf      stumpf  
 sharp      semi-sharp      blunt  
 agudos      semi-agudos      romo  
 acuti      semi-acuti      smusso

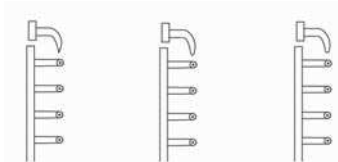

7,0 cm, 2<sup>3</sup>/<sub>4</sub>" **AK-1997-07**    **AK-1998-07**    **AK-1999-07**  
 10,0 cm, 4"    **AK-2000-10**    **AK-2001-10**    **AK-2002-10**



**ALLPORT**  
 9,5 cm, 3<sup>3</sup>/<sub>4</sub>"  
**AK-2003-09**



**SALP-CONTOUR**  
 14,0 cm, 5 1/2"



**AK-2004-14**  
 scharf  
 sharp  
 agudos  
 acuti



**AK-2005-14**  
 stumpf  
 blunt  
 romo  
 smusso



**ADSON-BABY**  
 16,0 cm, 6 1/4"



**AK-2006-16**  
 scharf  
 sharp  
 agudos  
 acuti



**AK-2007-16**  
 stumpf  
 blunt  
 romo  
 smusso



**ANDERSON-ADSON**  
 20,0 cm, 8"



**AK-2008-14**  
 scharf  
 sharp  
 agudos  
 acuti



**AK-2009-14**  
 stumpf  
 blunt  
 romo  
 smusso



**ADSON**  
 26,5 cm, 10 1/2"



**AK-2010-16**  
 scharf  
 sharp  
 agudos  
 acuti



**AK-2011-16**  
 stumpf  
 blunt  
 romo  
 smusso

Wundspreizer  
 Self-Retaining Retractors  
 Separadores con retenida automática  
 Divaricatori autostatici



**MOLLISON**  
 15,5 cm, 6"  
 AK-2012-15



scharf  
 sharp  
 agudos  
 acuti



**SCHUHKNECHT**  
 12,5 cm, 5"



**AK-2013-14**  
 scharf  
 sharp  
 agudos  
 acuti



**AK-2014-14**  
 stumpf  
 blunt  
 romo  
 smusso



**WULLSTEIN**



scharf  
 sharp  
 agudos  
 acuti

stumpf  
 blunt  
 romo  
 smusso

10,5 cm, 4 <sup>1</sup> / <sub>8</sub> "	<b>AK-2015-10</b>	<b>AK-2016-10</b>
13,0 cm, 5"	<b>AK-2015-13</b>	<b>AK-2016-13</b>
15,0 cm, 6"	<b>AK-2015-15</b>	<b>AK-2016-15</b>
18,0 cm, 7"	<b>AK-2015-18</b>	<b>AK-2016-18</b>



**MAYO-ADAMS**  
 16,5 cm, 6<sup>1</sup>/<sub>2</sub>"  
 AK-2017-17

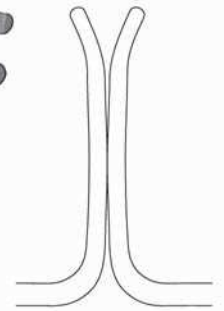

**Wundspreizer**  
**Self-Retaining Retractors**  
**Separadores con retenida automática**  
**Divaricatori autostatici**



**WEITLANER-LOKTITE**  
 10,5 cm, 4 1/8"



**AK-2018-10**  
 scharf  
 sharp  
 agudos  
 acuti



**AK-2019-10**  
 stumpf  
 blunt  
 romo  
 smusso



**WEITLANER**  
 13,0 cm, 5"



**AK-2020-13**  
 scharf  
 sharp  
 agudos  
 acuti



**AK-2021-13**  
 stumpf  
 blunt  
 romo  
 smusso



**WEITLANER**  
 16,5 cm, 6 1/2"



**AK-2022-16**  
 scharf  
 sharp  
 agudos  
 acuti



**AK-2023-16**  
 stumpf  
 blunt  
 romo  
 smusso



**WEITLANER**  
 20,0 cm, 8"



**AK-2024-20**  
 scharf  
 sharp  
 agudos  
 acuti



**AK-2025-20**  
 stumpf  
 blunt  
 romo  
 smusso

**Wundspreizer**  
**Self-Retaining Retractors**  
**Separadores con retenida automática**  
**Divaricatori autostatici**



**WEITLANER**  
 24,0 cm, 9½"



**AK-2026-20**    **AK-2027-20**  
 scharf  
 sharp  
 agudos  
 acuti  
 stumpf  
 blunt  
 romo  
 smusso



**PLESTER**  
 13,0 cm, 5"

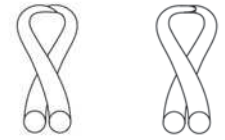

**AK-2028-13**    **AK-2029-13**  
 scharf  
 sharp  
 agudos  
 acuti  
 stumpf  
 blunt  
 romo  
 smusso



**MILLIGAN**  
 13,0 cm, 5"  
**AK-2030-13**

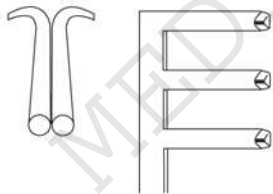

**PLESTER**  
 11,0 cm, 4¾"  
**AK-2031-11**

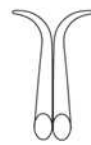

**PLESTER**  
 11,0 cm, 4¾"  
**AK-2032-11**

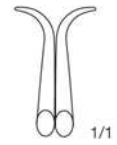



**Wundspreizer**  
**Self-Retaining Retractors**  
**Separadores con retenida automática**  
**Divaricatori autostatici**



**WEITLANER-BABY**  
 13,0 cm, 5"  
 AK-2035-13



**ADSON  
 (CONE)**

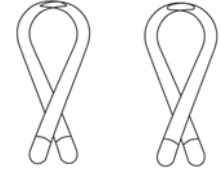

20,0 cm, 8" **AK-2033-20** **AK-2034-20**  
 26,0 cm, 10 1/4" **AK-2033-26** **AK-2034-26**

scharf	stumpf
sharp	blunt
agudos	romo
acuti	smusso



**GELPI**  
 13,5 cm, 5 3/8"  
 AK-2036-14



**GELPI**  
 19,0 cm, 7 1/2"  
 AK-2037-19



**GELPI-LOKTITE**  
 19,0 cm, 7 1/2"  
 AK-2038-19

Wundspreizer  
 Self-Retaining Retractors  
 Separadores con retenida automática  
 Divaricatori autostatici



**BECKMANN-ADSON**  
 31,0 cm, 12 1/4"

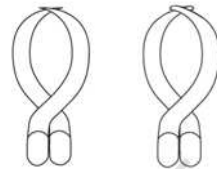

25 x 25 mm	<b>AK-2039-01</b>	<b>AK-2040-01</b>
25 x 31 mm	<b>AK-2039-02</b>	<b>AK-2040-02</b>
25 x 40 mm	<b>AK-2039-03</b>	<b>AK-2040-03</b>
25 x 45 mm	<b>AK-2039-04</b>	<b>AK-2040-04</b>

scharf	stumpf
sharp	blunt
agudos	romo
acuti	smusso

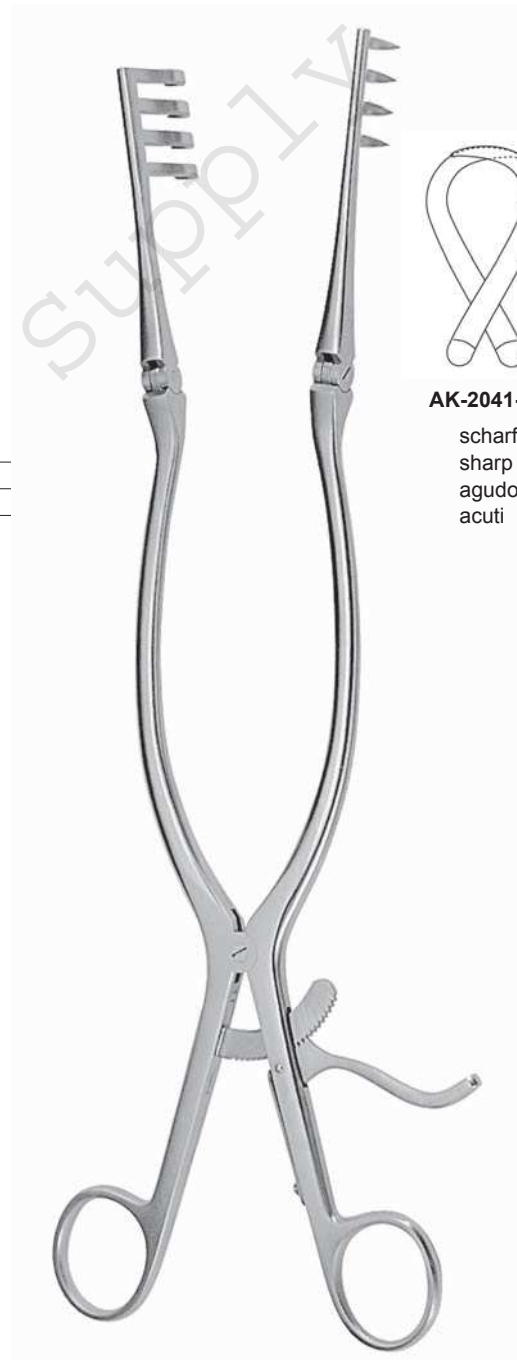

**BECKMANN**  
 31,0 cm, 12 1/4"



**AK-2041-31**  
 scharf  
 sharp  
 agudos  
 acuti



**AK-2042-32**

stumpf  
blunt  
romo  
smusso



-----  
**ADSON**  
32,0 cm, 12½"



10,0 cm, 4" **AK-2043-10**  
14,0 cm, 5½" **AK-2043-14**

**DE BAKEY**

**Wundspreizer**  
**Self-Retaining Retractors**  
**Separadores con retenida automática**  
**Divaricatori autostatici**

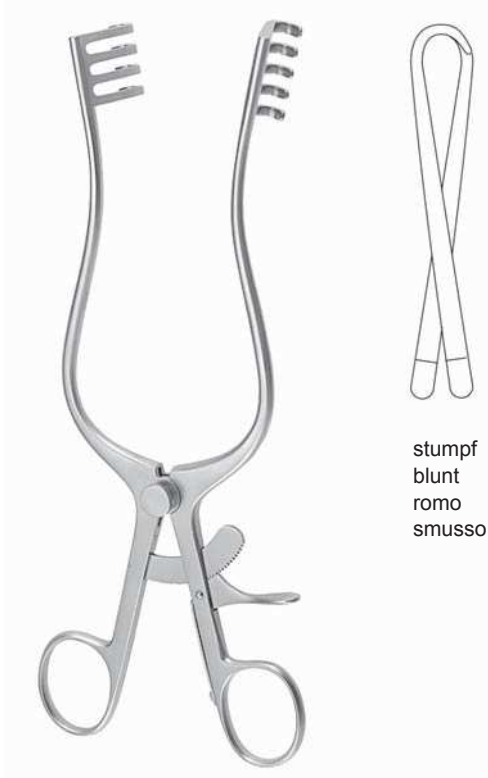

**NORFOLK AND NORWICH**  
 22,0 cm, 8<sup>5</sup>/<sub>8</sub>"  
**AK-2044-22**

stumpf  
 blunt  
 romo  
 smusso

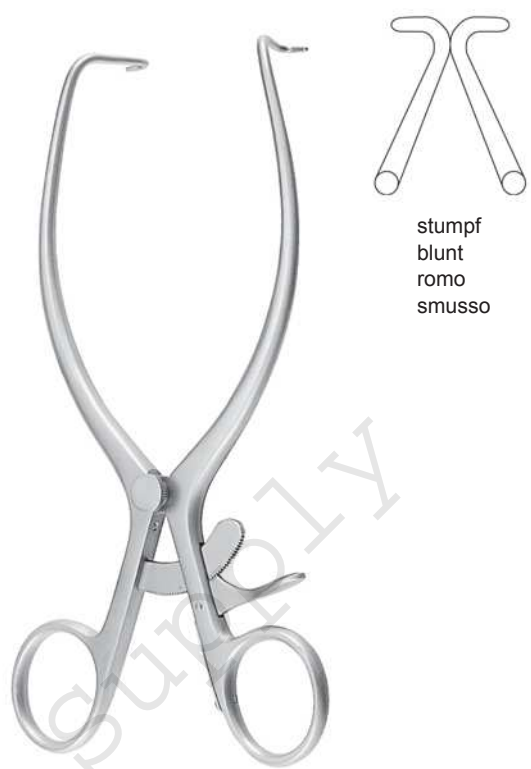

**JACKSON BURROWS**  
 17,5 cm, 7"  
**AK-2045-17**

stumpf  
 blunt  
 romo  
 smusso



**RICHTER**  
 17,0 cm, 6<sup>3</sup>/<sub>4</sub>"  
**AK-2046-17**



**JOLL (FRIEDMAN)**  
 15,5 cm, 6"  
**AK-2047-15**

**Wundspreizer  
Self-Retaining Retractors  
Separadores con retenida automática  
Divaricatori autostatici**

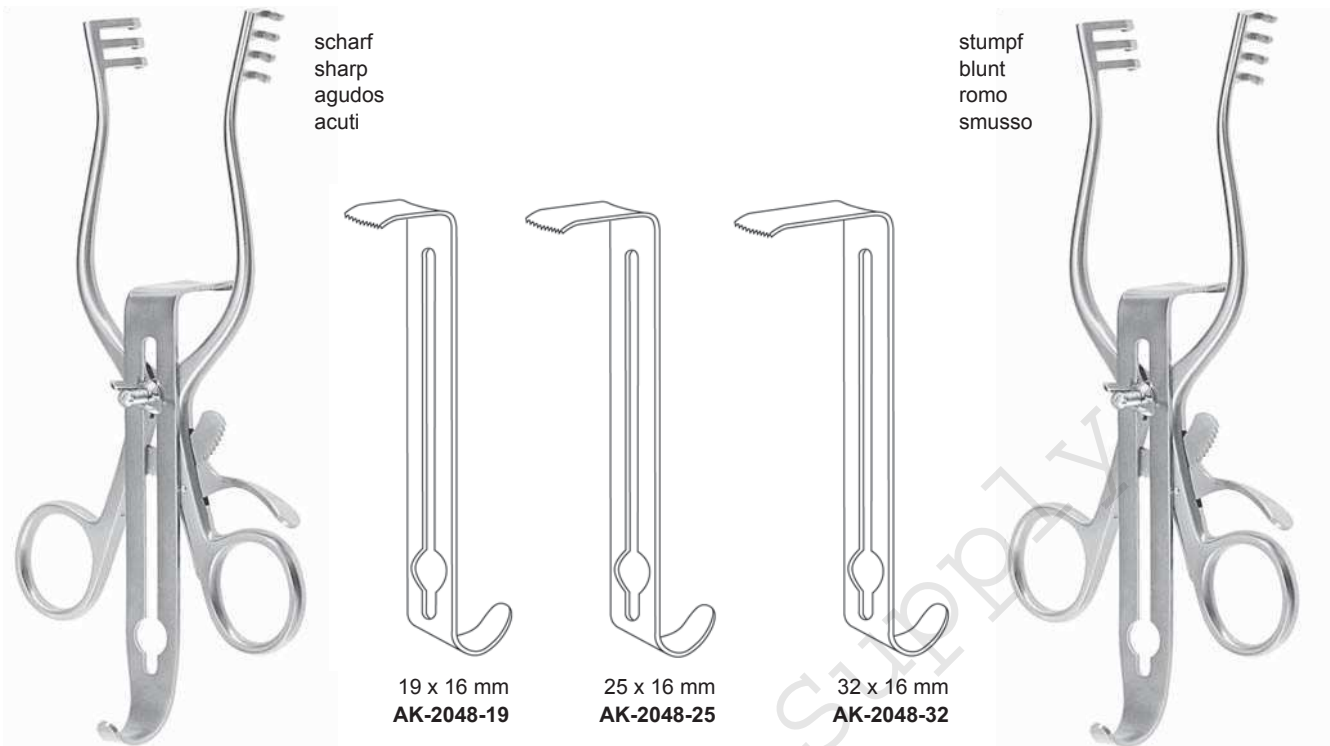

**HENLEY**  
16,0 cm, 6<sup>1</sup>/<sub>4</sub>"  
**AK-2048-16**

**HENLEY**  
16,0 cm, 6<sup>1</sup>/<sub>4</sub>"  
**AK-2049-16**

**HENLEY  
AK-2050-00**

komplett, bestehend aus:

- 1 Sperrer mit Seitenvalven, scharf (AK-300-16)
- 1 Mittelvalve 19 x 16 mm (AK-300-19)
- 1 Mittelvalve 25 x 16 mm (AK-300-25)
- 1 Mittelvalve 32 x 16 mm (AK-300-32)

complete, consisting of:

- 1 Spreader with lateral valves, sharp (AK-300-16)
- 1 Central valve 19 x 16 mm (AK-300-19)
- 1 Central valve 25 x 16 mm (AK-300-25)
- 1 Central valve 32 x 16 mm (AK-300-32)

completo, compuesto of:

- 1 Separador con valvas laterales, agudas (AK-300-16)
- 1 Valva central 19 x 16 mm (AK-300-19)
- 1 Valva central 25 x 16 mm (AK-300-25)
- 1 Valva central 32 x 16 mm (AK-300-32)

completo, composto da:

- 1 Divaricatore con valve laterali, acuto (AK-300-16)
- 1 Valva centrale 19 x 16 mm (AK-300-19)
- 1 Valva centrale 25 x 16 mm (AK-300-25)
- 1 Valva centrale 32 x 16 mm (AK-300-32)

**HENLEY  
AK-2051-00**

komplett, bestehend aus:

- 1 Sperrer mit Seitenvalven, stumpf (AK-301-16)
- 1 Mittelvalve 19 x 16 mm (AK-300-19)
- 1 Mittelvalve 25 x 16 mm (AK-300-25)
- 1 Mittelvalve 32 x 16 mm (AK-300-32)

complete, consisting of:

- 1 Spreader with lateral valves, blunt (AK-301-16)
- 1 Central valve 19 x 16 mm (AK-300-19)
- 1 Central valve 25 x 16 mm (AK-300-25)
- 1 Central valve 32 x 16 mm (AK-300-32)

completo, compuesto of:

- 1 Separador con valvas laterales, romas (AK-301-16)
- 1 Valva central 19 x 16 mm (AK-300-19)
- 1 Valva central 25 x 16 mm (AK-300-25)
- 1 Valva central 32 x 16 mm (AK-300-32)

completo, composto da:

- 1 Divaricatore con valve laterali, smusso (AK-301-16)
- 1 Valva centrale 19 x 16 mm (AK-300-19)
- 1 Valva centrale 25 x 16 mm (AK-300-25)
- 1 Valva centrale 32 x 16 mm (AK-300-32)

**Wundspreizer, Bauchdeckenhalter**  
**Self-Retaining Retractors, Abdominal Retractors**  
**Separadores con retenida automática, Separadores abdominales**  
**Divaricatori autostatici, Divaricatori addominali**



**MAYO-ADAMS**  
 17,0 cm, 6<sup>3</sup>/<sub>4</sub>"  
**AK-2054-17**



**COLLIN-BABY**  
 18,0 cm, 7"  
**AK-2055-18**

30 x 44 mm  
**AK-2052-30**



23 x 44 mm  
**AK-2053-23**

Wechselvalven  
 Exchangeable blades  
 Valvas intergambiabiles  
 Valve intercambiabili



**RICARD**  
 28,0 cm, 11"  
**AK-2056-28**



**RICARD**  
 30,0 cm, 12"  
**AK-2057-30**

**Wundspreizer, Bauchdeckenhalter**  
**Self-Retaining Retractors, Abdominal Retractors**  
**Separadores con retenida automática, Separadores abdominales**  
**Divaricatori autostatici, Divaricatori addominali**



**COLLIN**  
 23,5 cm, 9 1/4"  
**AK-2058-24**

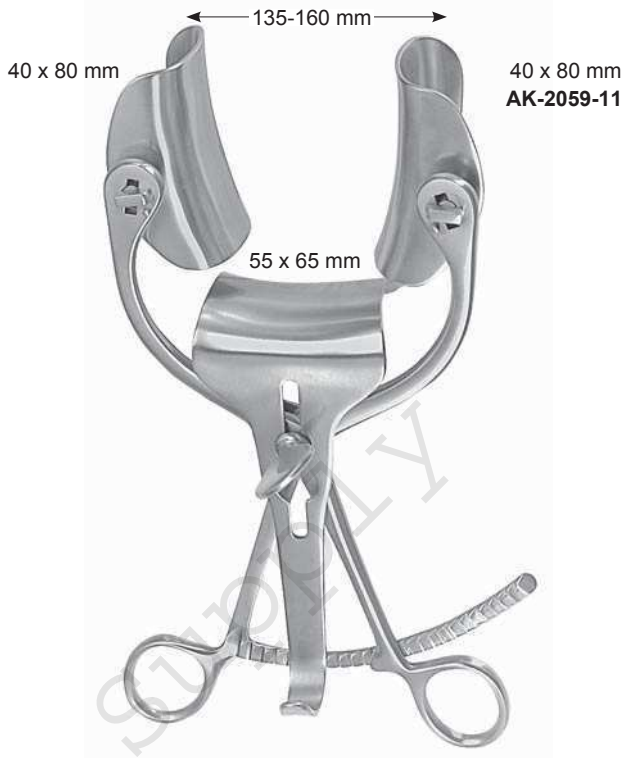

**COLLIN**  
 23,5 cm, 9 1/4"  
**AK-2059-24**



**COLLIN**  
 23,5 cm, 9 1/4"  
**AK-2060-24**



**ROBIN-MASSE**  
**AK-2061-27**

Wundspreizer, Bauchdeckenhalter  
 Self-Retaining Retractors, Abdominal Retractors  
 Separadores con retenida automática, Separadores abdominales  
 Divaricatori autostatici, Divaricatori addominali



38 x 62 mm	<b>AK-2062-01</b>
40 x 80 mm	<b>AK-2062-02</b>
60 x 80 mm	<b>AK-2062-03</b>

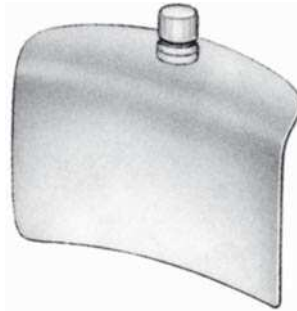

50 x 58 mm	<b>AK-2063-10</b>
60 x 80 mm	<b>AK-2063-13</b>
72 x 85 mm	<b>AK-2063-14</b>



<b>AK-2064-23</b>
60 x 80 mm



<b>AK-2067-33</b>
60 x 80 mm



58 x 50 mm	<b>AK-2065-01</b>
80 x 60 mm	<b>AK-2065-02</b>
85 x 72 mm	<b>AK-2065-03</b>



62 x 38 mm	<b>AK-2066-10</b>
80 x 38 mm	<b>AK-2066-11</b>
100 x 38 mm	<b>AK-2066-12</b>
80 x 38 mm	<b>AK-2066-13</b>



<b>COLLIN</b>	
55 x 55 mm	<b>AK-2068-01</b>
55 x 65 mm	<b>AK-2068-02</b>
55 x 75 mm	<b>AK-2068-03</b>



<b>ROBIN-MASSE</b>	
40 x 64 mm	<b>AK-2069-01</b>
55 x 65 mm	<b>AK-2069-02</b>
55 x 75 mm	<b>AK-2069-03</b>



<b>RICARD</b>	
65 x 50 mm	<b>AK-2070-01</b>
70 x 55 mm	<b>AK-2070-02</b>
90 x 80 mm	<b>AK-2070-03</b>



Bauchdeckenhalter  
Abdominal Retractors  
Separadores abdominales  
Divaricatori addominali



**GOSSET**  
**AK-2071-10**



**GOSSET**  
**AK-2072-14**



**GOSSET**  
**AK-2073-16**

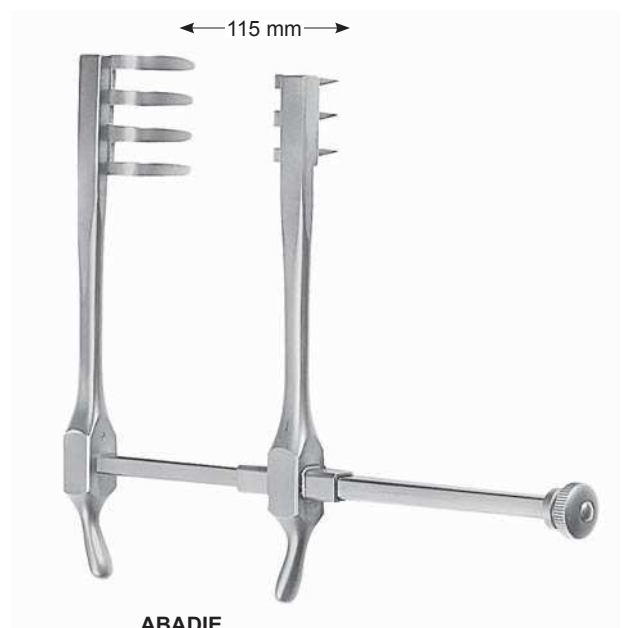

**ABADIE**  
**AK-2074-12**

**Bauchdeckenhalter**  
**Abdominal Retractors**  
**Separadores abdominales**  
**Divaricatori addominali**



**BALFOUR**  
**AK-2075-18**



**BALFOUR**  
**AK-2076-20**



**BALFOUR**  
**AK-2077-25**

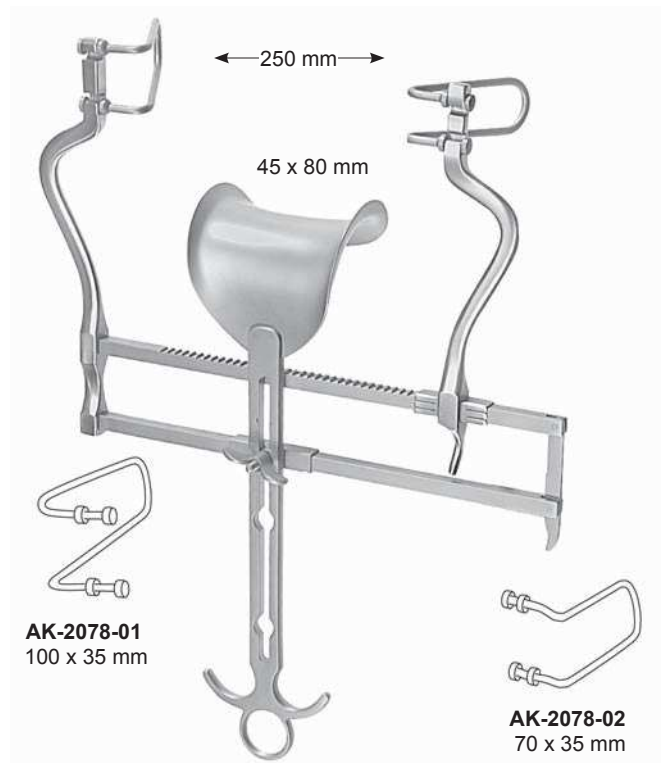

**BALFOUR US-TYPE**  
**AK-2078-25**

**AK-2078-01**  
 100 x 35 mm

**AK-2078-02**  
 70 x 35 mm

Bauchdeckenhalter  
Abdominal Retractors  
Separadores abdominales  
Divaricatori addominali



**BALFOUR**  
100 x 70 mm  
AK-2079-70

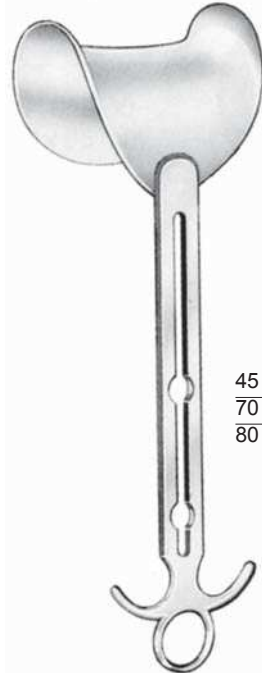

**BALFOUR**

45 x 80 mm **AK-2079-01**  
70 x 85 mm **AK-2079-02**  
80 x 90 mm **AK-2079-03**



**BALFOUR**  
AK-2080-09



**BERKELEY**  
AK-2081-00

35 x 60 mm  
AK-2081-01

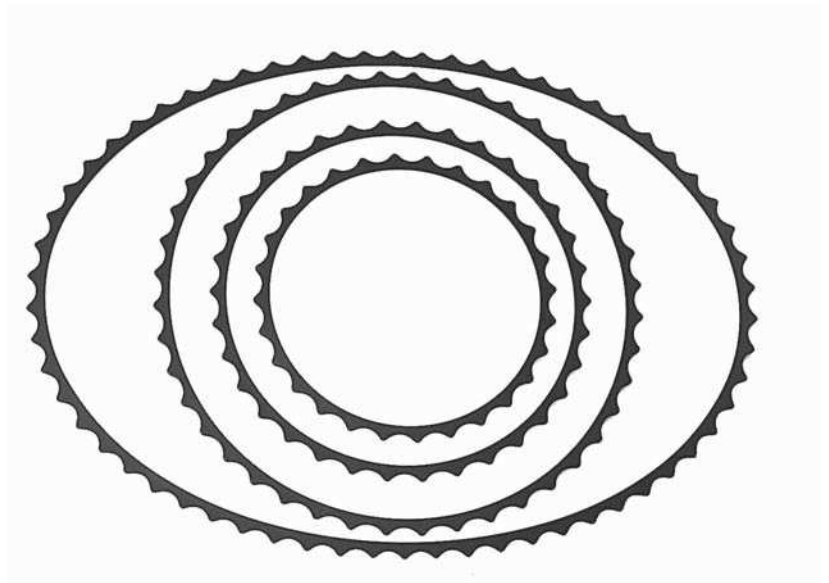

**TURNER-WARNICK**  
modifiziert

Ø 180 mm, 7" **AK-2081-18**  
Ø 230 mm, 9" **AK-2081-23**  
Ø 305 mm, 12" **AK-2081-30**  
455 x 330 mm **AK-2081-45**

Bauchdeckenhalter  
Abdominal Retractors  
Separadores abdominales  
Divaricatori addominali

geschwärzt, black finish, negra, nera



**AK-2082-01**  
13 mm



**AK-2082-02**  
51 x 38 mm



**AK-2082-03**  
70 x 60 mm



**AK-2082-04**  
89 x 60 mm



**AK-2082-05**  
114 x 60 mm

**TURNER-WARNICK**  
modifiziert

geschwärzt, black finish, negra, nera



**AK-2083-06**  
19 x 76 mm



**AK-2083-07**  
38 x 102 mm



**AK-2083-08**  
57 x 89 mm



**AK-2083-09**  
57 x 114 mm

**AK-2084-11**  
 40 x 30 mm

**AK-2084-22**  
 40 x 40 mm



40 x 30 mm

**AK-2084-01**  
 255 x 180 mm  
 Rahmen allein  
 frame only  
 cuadro suelto  
 solo telaio

**DENNIS BROWN**  
 255 x 180 mm  
**AK-2084-00**  
 komplett complete  
 completo completo



**AK-2085-12**  
 110 x 70 mm

**AK-2085-11**  
 80 x 45 mm

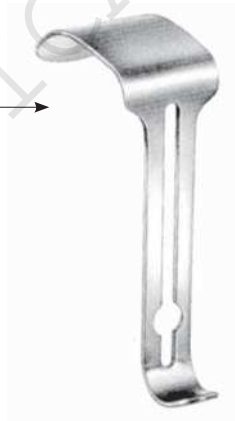

**AK-2085-01**  
 Rahmen allein  
 frame only  
 cuadro suelto  
 solo telaio

**O'SULLIVAN-O'CONNOR**  
**AK-2085-00**  
 komplett  
 complete  
 completo  
 completo

**Bauchdeckenhalter**  
**Abdominal Retractors**  
**Separadores abdominales**  
**Divaricatori addominali**

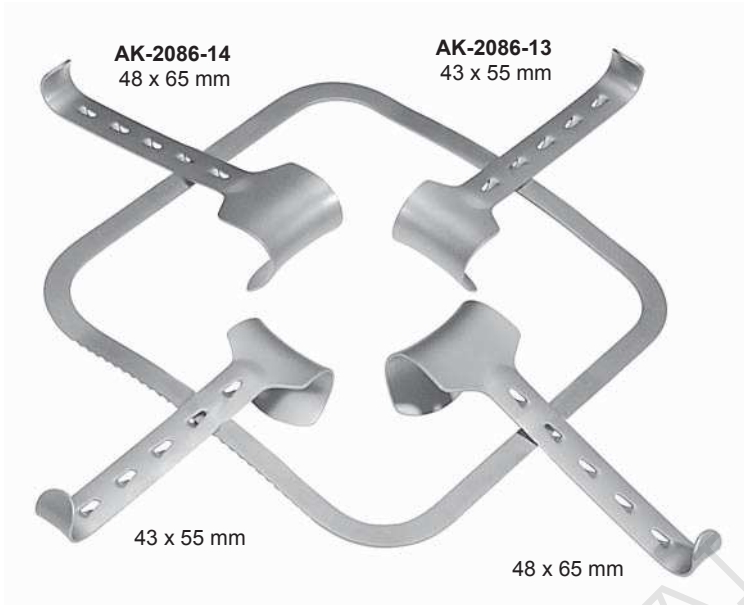

**AK-2086-01** 250 x 250 mm  
**AK-2087-01** 300 x 320 mm  
**AK-2088-01** 300 x 380 mm  
 Rahmen allein  
 frame only  
 cuadro suelto  
 solo telaio

**KIRSCHNER**  
**AK-2089-00**  
 komplett  
 complete  
 completo  
 completo  
 1 x AK-880-01  
 2 x AK-880-13  
 2 x AK-880-14

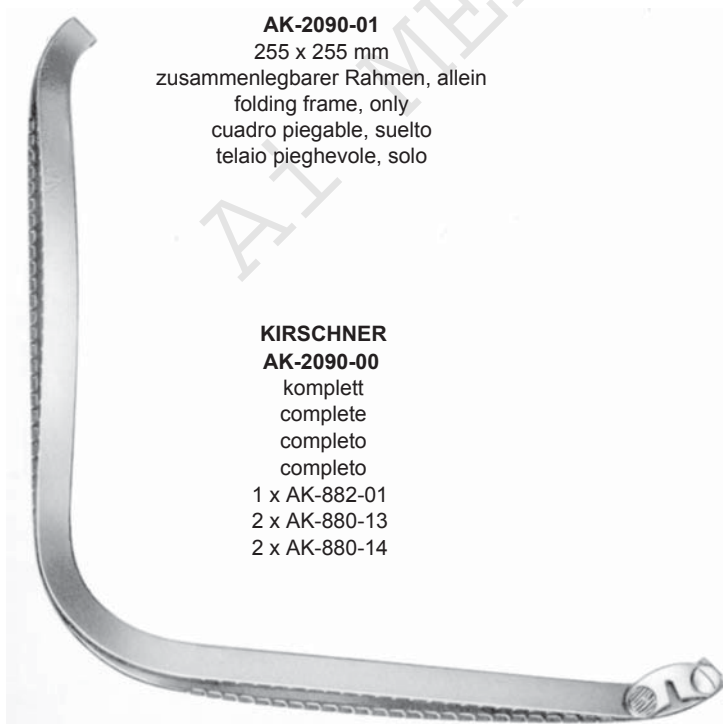

**AK-2090-01**  
 255 x 255 mm  
 zusammenlegbarer Rahmen, allein  
 folding frame, only  
 cuadro plegable, suelto  
 telaio pieghevole, solo

**KIRSCHNER**  
**AK-2090-00**  
 komplett  
 complete  
 completo  
 completo  
 1 x AK-882-01  
 2 x AK-880-13  
 2 x AK-880-14



43 x 55 mm	<b>AK-2091-13</b>
48 x 65 mm	<b>AK-2091-14</b>
80 x 90 mm	<b>AK-2091-15</b>
90 x 65 mm	<b>AK-2091-16</b>
98x95mm	<b>AK-2091-17</b>

**KIRSCHNER**



**KIRSCHNER**  
60 x 82 mm  
AK-2092-11



**KIRSCHNER-BALFOUR**  
83 x 82 mm  
AK-2092-12



**KIRSCHNER**  
98 x 51 mm AK-2092-20  
105 x 38 mm AK-2092-21

**AK-2093-14**  
48 x 65 mm

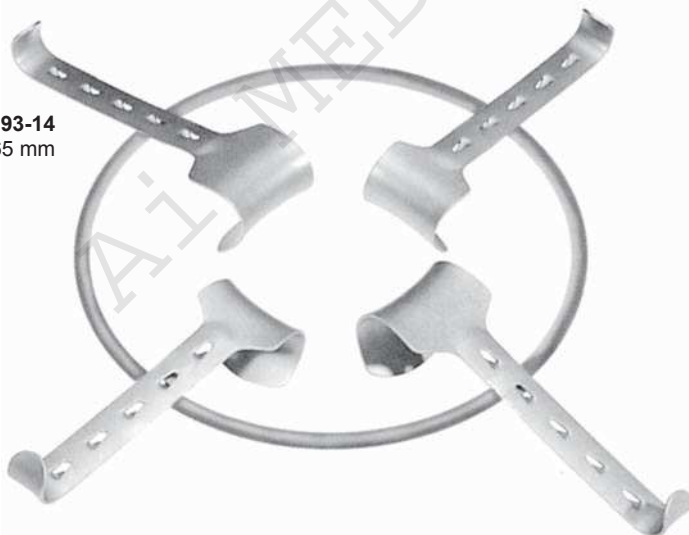

**KIRSCHNER, oval**  
**AK-2096-00**  
komplett, complete, completo, completo  
1 x AK-094-01  
3 x AK-093-14  
1 x AK-095-15  
1 x AK-097-20  
1 x AK-097-21

**AK-2094-01**  
300 x 240 mm  
Rahmen allein  
frame only  
cuadro suelto  
solo telaio

**AK-2095-15**  
80 x 90 mm



**KIRSCHNER**  
98 x 51 mm AK-2097-20  
105 x 38 mm AK-2097-21

**Bauchdeckenhalter**  
**Abdominal Retractors**  
**Separadores abdominales**  
**Divaricatori addominali**

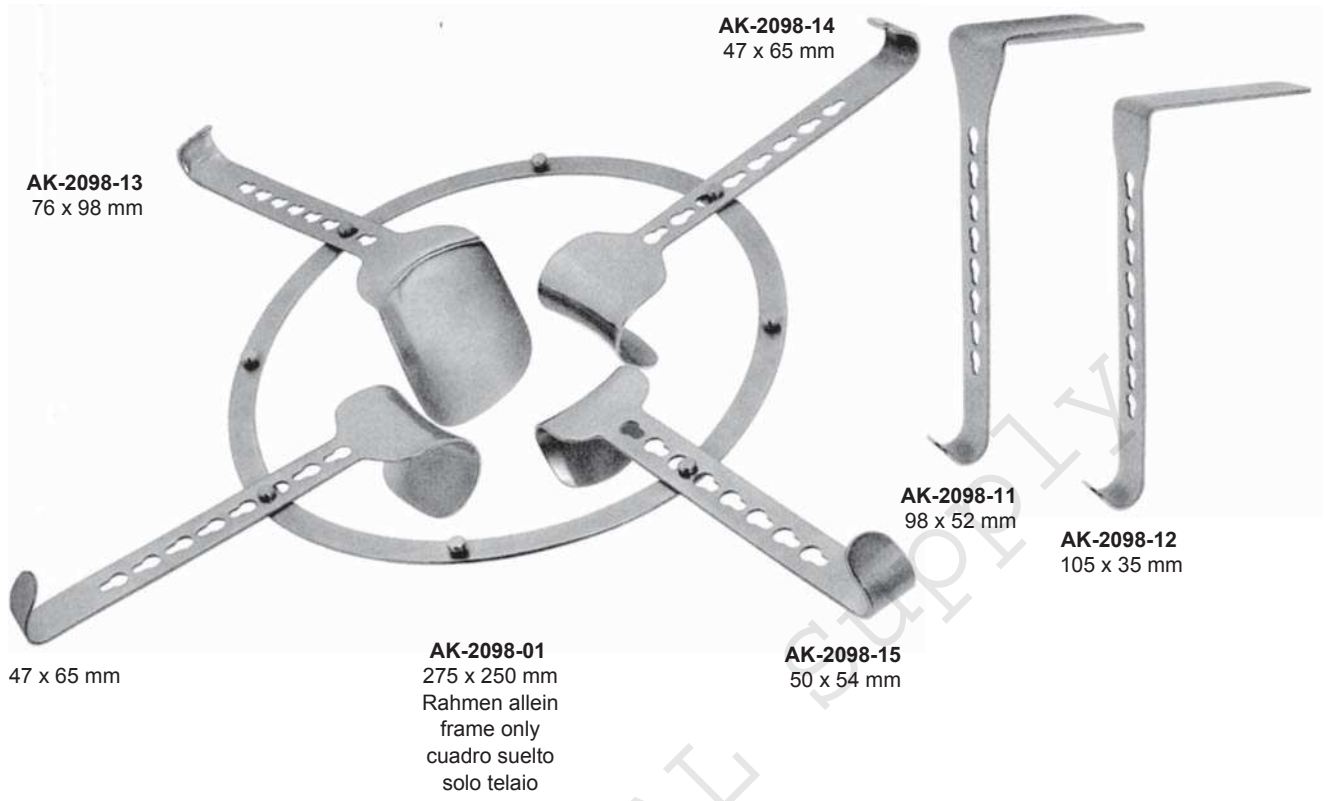

47 x 65 mm

**AK-2098-01**  
 275 x 250 mm  
 Rahmen allein  
 frame only  
 cuadro suelto  
 solo telaio

**AK-2098-14**  
 47 x 65 mm

**AK-2098-11**  
 98 x 52 mm

**AK-2098-12**  
 105 x 35 mm

**AK-2098-15**  
 50 x 54 mm



**AK-2099-13**  
 38 x 60 mm

**AK-2099-11**  
 50 x 65 mm

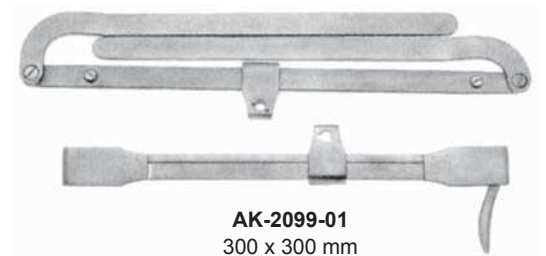

**AK-2099-01**  
 300 x 300 mm  
 zusammenlegbarer Rahmen, allein  
 folding frame, only  
 cuadro plegable, suelto  
 telaio pieghevole, solo

**FRANZ**  
**RT-2099-00**  
 komplett  
 complete  
 completo  
 completo  
 1 x AK-2099-01  
 2 x AK-2099-11  
 2 x AK-2099-13



38 x 60 mm **AK-2099-13**  
 45 x 80 mm **AK-2099-14**



50 x 65 mm **AK-2099-11**  
 60 x 85 mm **AK-2099-12**



**Bauchdeckenhalter**  
**Abdominal Retractors**  
**Separadores abdominales**  
**Divaricatori addominali**

für / for / para / per  
 AK-2100-11  
 AK-2100-14



95 x 60 mm	<b>AK-2100-11</b>
105 x 65 mm	<b>AK-2100-12</b>
115 x 65 mm	<b>AK-2101-13</b>
125 x 65 mm	<b>AK-2101-14</b>

**DOYEN**  
 28,0 cm, 11"



Kette mit Gewicht  
 Chain with weight  
 Cadena con pesa  
 Catena con peso

**AK-2102-30**  
 78,5 cm, 31"



53,0 cm, 21"  
 66,0 cm, 26"

Befestigungsgestell  
 Mounting frame  
 Bastidor para la fijación  
 Telaio di supporto per il fissaggio

**ROCHARD**  
**AK-2103-30**



53,0 cm, 21"  
 66,0 cm, 26"

Befestigungsgestell  
 Mounting frame  
 Bastidor para la fijación  
 Telaio di supporto per il fissaggio

**ROCHARD**  
**AK-2104-02**



**ROCHARD**  
 28,0 cm, 11"  
**AK-2104-20**

95 x 48 mm	<b>AK-2104-10</b>
105 x 48 mm	<b>AK-2104-12</b>
115 x 48 mm	<b>AK-2104-12</b>
125 x 48 mm	<b>AK-2104-13</b>
155 x 48 mm	<b>AK-2104-16</b>

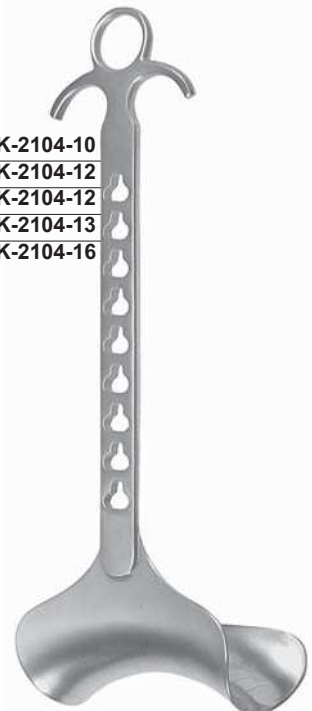

**ROCHARD**  
 28,0 cm, 11"

Bauchspatel  
Abdominal Spatulas  
Espátulas abdominales  
Spatole addominali



biegsam  
malleable  
maleable  
malleabile

- |             |                   |
|-------------|-------------------|
| 200 x 6 mm  | <b>AK-2105-06</b> |
| 200 x 12 mm | <b>AK-2105-12</b> |
| 200 x 17 mm | <b>AK-2105-17</b> |
| 200 x 20 mm | <b>AK-2105-20</b> |
| 200 x 25 mm | <b>AK-2105-25</b> |



biegsam  
malleable  
maleable  
malleabile

- |             |                   |
|-------------|-------------------|
| 330 x 13 mm | <b>AK-2106-13</b> |
| 330 x 25 mm | <b>AK-2106-25</b> |
| 330 x 32 mm | <b>AK-2106-32</b> |
| 330 x 40 mm | <b>AK-2106-40</b> |
| 330 x 50 mm | <b>AK-2106-50</b> |

**RIBBON**



biegsam  
malleable  
maleable  
malleabile

- |                |                   |
|----------------|-------------------|
| 280 x 25/30 mm | <b>AK-2107-01</b> |
| 300 x 37/45 mm | <b>AK-2107-02</b> |
| 300 x 40/50 mm | <b>AK-2107-03</b> |

**RIBBON**

**RIBBON**



biegsam  
malleable  
maleable  
malleabile

**TUFFIER**  
200 x 25/17 mm  
**AK-2108-20**



**REVERDIN**  
280 x 45/60 mm  
**AK-2109-28**



rostfrei  
 stainless steel  
 inox  
 arrugginimento

a	b	c	
18 mm	20 mm	75 mm	<b>AK-2110-01</b>

**FINOCCHIETTO-BABY**



rostfrei  
 stainless steel  
 inox  
 arrugginimento

a	b	c	
40 mm	40 mm	165 mm	<b>AK-2110-02</b>
45 mm	65 mm	200 mm	<b>AK-2110-03</b>
70 mm	65 mm	250 mm	<b>AK-2110-04</b>

**FINOCCHIETTO**



rostfrei  
 stainless steel  
 inox  
 arrugginimento

a	b	c	
50 mm	45 mm	165 mm	<b>AK-2111-01</b>

**TUFFIER**

**Sonden, Trokare**  
**Probes, Trocars**  
**Sondas, Trócares**  
**Sonde, Trequarti**



Sonden  
Probes  
Sondas  
Sonde

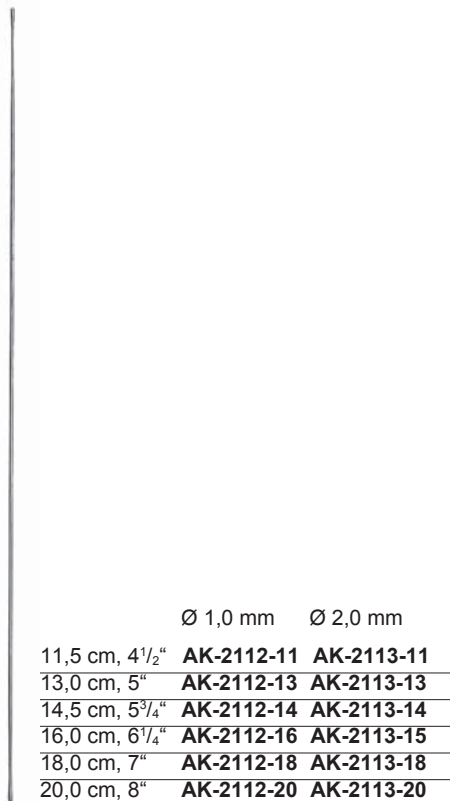

Ø 2,0 mm



11,5 cm, 4 1/2"	<b>AK-2115-11</b>
13,0 cm, 5"	<b>AK-2115-13</b>
14,5 cm, 5 3/4"	<b>AK-2115-14</b>
16,0 cm, 6 1/4"	<b>AK-2115-16</b>
18,0 cm, 7"	<b>AK-2115-18</b>
20,0 cm, 8"	<b>AK-2115-20</b>

Ø 1,0 mm



Silber  
Silver  
Plata  
Argento

**STACKE**  
10,5 cm, 4 1/8"  
**AK-2115-10**



Myrtenblattsonden  
Myrtle leaf probes  
Sondas para mirto  
Sonde a foglia di mirto

11,5 cm, 4 1/2"	<b>AK-2116-11</b>
13,0 cm, 5"	<b>AK-2116-13</b>
14,5 cm, 5 3/4"	<b>AK-2116-14</b>
16,0 cm, 6 1/4"	<b>AK-2116-16</b>
18,0 cm, 7"	<b>AK-2116-18</b>
20,0 cm, 8"	<b>AK-2116-20</b>



**NÈLATON**  
16,0 cm, 6 1/4"  
**AK-2117-16**



**DOYEN**  
14,5 cm, 5 3/4"  
**AK-2118-14**



**BRODIE**  
20,0 cm, 8"  
**AK-2119-20**

Ø 3,5 mm

Ø 3,5 mm



11,5 cm, 4½" **AK-2120-11**  
 13,0 cm, 5" **AK-2120-13**  
 14,5 cm, 5¾" **AK-2120-14**  
 16,0 cm, 6¼" **AK-2120-16**  
 18,0 cm, 7" **AK-2120-18**  
 20,0 cm, 8" **AK-2120-20**

Ø 3,3 mm



13,0 cm, 5" **AK-2121-13**  
 14,5 cm, 5¾" **AK-2121-14**  
 16,0 cm, 6¼" **AK-2121-16**  
 18,0 cm, 7" **AK-2121-18**



**LOCKHART-MUMMERY**  
 16,5 cm, 6½"  
**AK-2122-01**



**LOCKHART-MUMMERY**  
 16,5 cm, 6½"  
**AK-2122-02**

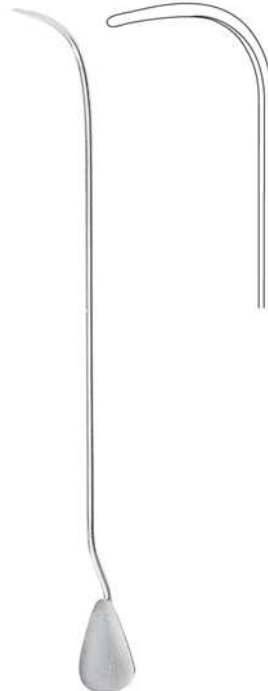

**LOCKHART-MUMMERY**  
 16,5 cm, 6½"  
**AK-2122-03**

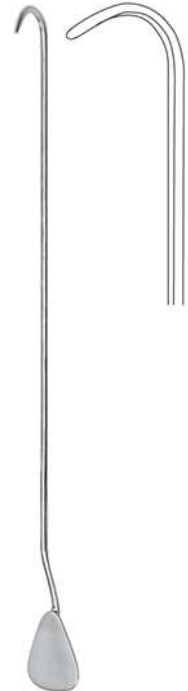

**LOCKHART-MUMMERY**  
 16,5 cm, 6½"  
**AK-2122-04**

Watteträger  
 Cotton Applicators  
 Porta-algodones  
 Porta-cotone

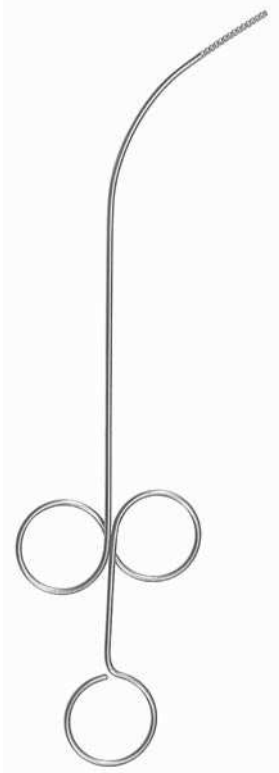

**FEIN**  
 28,0 cm, 11"  
**AK-2123-28**



**UKERMANN**  
 16,0 cm, 6 1/4"  
**AK-2124-16**



**JOBSON-HORNE**  
 18,0 cm, 7"  
**AK-2125-18**



12,0 cm, 4 3/4"	<b>AK-2126-12</b>	Ø 0,9 mm
14,0 cm, 5 3/4"	<b>AK-2126-14</b>	Ø 0,9 mm
16,5 cm, 6 1/4"	<b>AK-2126-16</b>	Ø 1,1 mm
18,0 cm, 7"	<b>AK-2126-18</b>	Ø 1,2 mm

**FARRELL**  
**(LATHBURY)**



12,0 cm, 4 3/4"	<b>AK-2127-12</b>	Ø 0,9 mm
14,0 cm, 5 3/4"	<b>AK-2127-14</b>	Ø 0,9 mm
16,5 cm, 6 1/4"	<b>AK-2127-16</b>	Ø 1,1 mm
18,0 cm, 7"	<b>AK-2127-18</b>	Ø 1,2 mm

**FARRELL**

AI MEDICAL Supply

**Krampfader-Besteck**  
**Varicose Vein Probe Set**  
**Juego para várices**  
**Astuccio per varici**



**AK-2128-01**  
 Metalletui  
 Metal case  
 Estuche de metal  
 Scatola in metallo

135 x 100 x 25 mm

**NABATOFF**  
**AK-2128-00**  
 komplett  
 complete  
 completo  
 completo



Ø 3,0 mm  
**AK-2128-03**



Ø 6,0 mm  
**AK-2128-06**



Ø 9,0 mm  
**AK-2128-09**



Ø 12,0 mm  
**AK-2128-12**



**AK-2128-21**  
 Zugseil  
 Cable  
 Cable  
 Fune

**AK-2128-22**  
 Kunststoff-Sondenspitze  
 Plastic probe tip  
 Extremidad de sonda de plástico  
 Punta in materia plastica

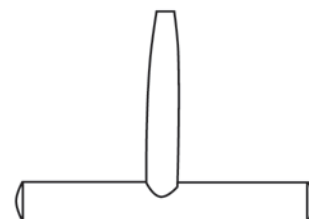

**AK-2128-20**  
 Handgriff  
 Handle  
 Mango  
 Manico



Trokare  
Trocars  
Trócares  
Tre quarti



Ø 3,0 mm	<b>AK-2129-30</b>
Ø 3,5 mm	<b>AK-2129-35</b>
Ø 4,0 mm	<b>AK-2129-40</b>
Ø 4,5 mm	<b>AK-2129-45</b>
Ø 5,0 mm	<b>AK-2129-50</b>
Ø 5,5 mm	<b>AK-2129-55</b>
Ø 6,0 mm	<b>AK-2129-60</b>

**STANDARD**  
11,0 cm, 4<sup>3</sup>/<sub>8</sub>"



Ø 3,0 mm	<b>AK-2130-30</b>
Ø 3,5 mm	<b>AK-2130-35</b>
Ø 4,0 mm	<b>AK-2130-40</b>
Ø 4,5 mm	<b>AK-2130-45</b>
Ø 5,0 mm	<b>AK-2130-50</b>
Ø 5,5 mm	<b>AK-2130-55</b>
Ø 6,0 mm	<b>AK-2130-60</b>

**STANDARD**  
12,0 cm, 4<sup>3</sup>/<sub>4</sub>"



Ø 3,0 mm	<b>AK-2131-30</b>
Ø 3,5 mm	<b>AK-2131-35</b>
Ø 4,0 mm	<b>AK-2131-40</b>
Ø 4,5 mm	<b>AK-2131-45</b>
Ø 5,0 mm	<b>AK-2131-50</b>
Ø 5,5 mm	<b>AK-2131-55</b>
Ø 6,0 mm	<b>AK-2131-60</b>

**STANDARD**  
12,0 cm, 4<sup>3</sup>/<sub>4</sub>"



Ø 7,3 mm	<b>AK-2132-07</b>
Ø 8,7 mm	<b>AK-2132-09</b>
Ø 12,0 mm	<b>AK-2132-12</b>

**HURWITZ**



**UNIVERSAL**  
**AK-2132-03**

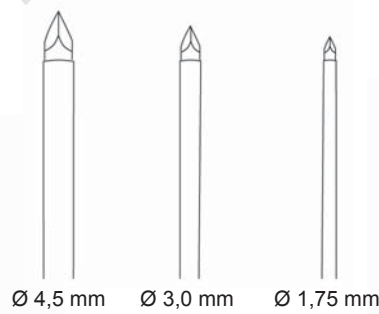

**UNIVERSAL**  
**AK-2132-04**

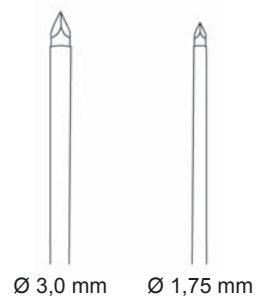
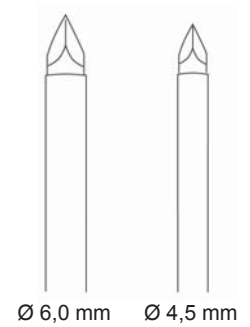

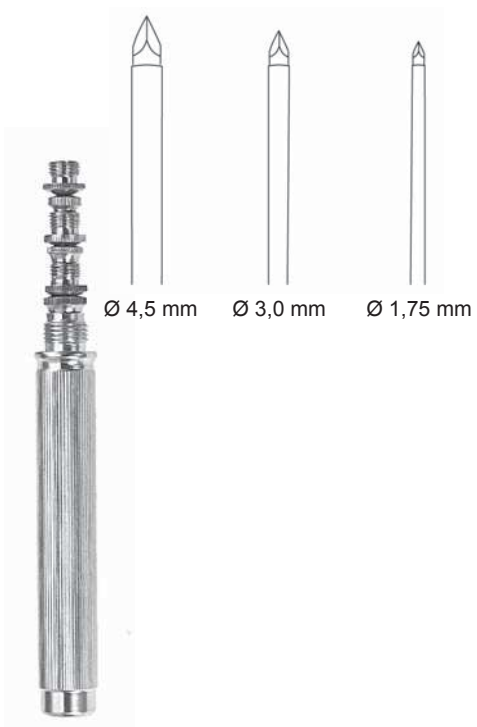

**UNIVERSAL**  
**AK-2133-03**



**UNIVERSAL**  
**AK-2133-04**

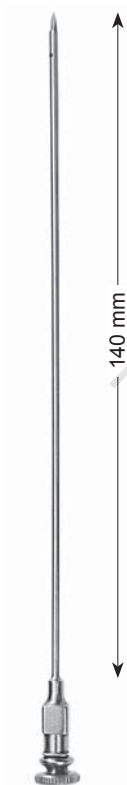

**LANDAU**  
Ø 2,0 mm  
**AK-2134-16**



**LANDAU**  
Ø 2,0 mm  
**AK-2135-16**



**DAVIDSON**  
Ø 6,0 mm  
**AK-2136-18**



**BUELAU**  
Ø 8,0 mm  
**AK-2137-24**

Trokare  
Trocars  
Trócares  
Treuarti



Ø 2,0 mm **AK-2138-20**  
 Ø 2,5 mm **AK-2138-25**  
 Ø 3,0 mm **AK-2138-30**

**LERMOYEZ**



Ø 6,0 mm **AK-2139-06**  
 Ø 8,0 mm **AK-2139-08**

**CAMPBELL**  
 16,0 cm, 6 1/4"



Ø 7,5 mm **AK-2140-01**  
 Ø 9,0 mm **AK-2140-02**  
 Ø 10,5 mm **AK-2140-03**  
 Ø 12,0 mm **AK-2140-04**

**NELSON**  
 21,0 cm, 8 1/2"

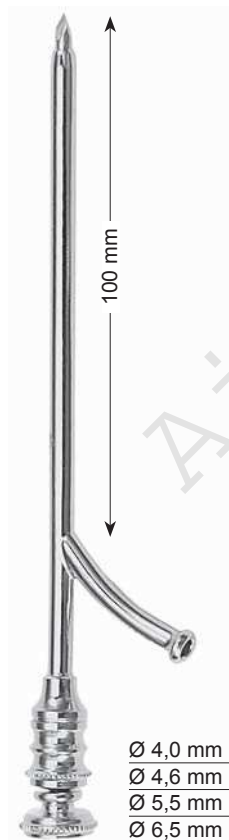

Ø 4,0 mm **AK-2141-01**  
 Ø 4,6 mm **AK-2141-02**  
 Ø 5,5 mm **AK-2141-03**  
 Ø 6,5 mm **AK-2141-04**

**OCHSNER**  
 14,0 cm, 5 1/2"



Record Konus  
 Record cone

Ø 3,0 mm **AK-2142-30**  
 Ø 4,0 mm **AK-2142-40**  
 Ø 5,0 mm **AK-2142-50**

**PIERCE**  
 16,0 cm, 6 1/4"

Ø 2,25 mm



**COAKLEY**  
 14,0 cm, 5 1/4"  
**AK-2143-14**



Ø 4,0 mm

**KRAUSE**  
16,0 cm, 6 1/4"

**LICHTWITZ**  
Kieferhöhlentrocars  
Antrum trocars  
Trócares para el seno maxilar  
Trequarti per puntura del seno mascellare

Ø 1,8 mm

- Ø 3,0 mm    **AK-2144-30**
- Ø 4,0 mm    **AK-2144-40**
- Ø 5,0 mm    **AK-2144-50**
- Ø 5,5 mm    **AK-2144-55**

**LICHTWITZ**  
20,0 cm, 8"  
**AK-2145-00**

**Trokare, Saugrohre**  
**Trocars, Suction Tubes**  
**Trócares, Tubos para aspiración**  
**Trequarti, Tubi aspirazione**



**LICHTWITZ**  
11,0 cm, 4 1/2"  
**AK-2145-00**



**DOUGLAS**  
Ø 3,0 mm  
**AK-2146-00**



**POOLE**  
22,0 cm, 8 5/8"

- Ø 6,0 mm    **AK-2147-06**
- Ø 10,0 mm   **AK-2147-10**



**POOLE**  
22,0 cm, 8 5/8"

- Ø 6,0 mm    **AK-2148-06**
- Ø 8,0 mm    **AK-2148-08**

**Saugrohre  
Suction Tubes  
Tubos para aspiración  
Tubi aspirazione**

auswechselbare Spitze  
interchangeable tip  
punta intercambiabile  
tipo intercambiabile



**COUPLAND**  
17,0 cm, 6<sup>3</sup>/<sub>4</sub>"  
**AK-2149-17**



Ø 3,5 mm  
**ST-2149-35**



**YANKAUER**  
27,0 cm, 10<sup>5</sup>/<sub>8</sub>"  
**AK-2150-27**



**ST-2150-00**  
Olive allein  
Olive only  
Oliva suelto  
Olivo solo



**DE BAKEY**  
27,0 cm, 10<sup>5</sup>/<sub>8</sub>"  
**AK-2151-27**



**ANTHONY**  
26,0 cm, 10<sup>1</sup>/<sub>4</sub>"  
**AK-2151-26**



**ANDREWS-PYNCHON**  
24,0 cm, 9<sup>1</sup>/<sub>2</sub>"  
**AK-2151-24**



**COOLEY**  
35,0 cm, 13<sup>3</sup>/<sub>4</sub>"  
Ø 8,0 mm  
**AK-2152-02**



**COOLEY**  
30,0 cm, 11<sup>3</sup>/<sub>4</sub>"  
Ø 7,0 mm  
**AK-2153-03**



**COOLEY**  
31,0 cm, 11<sup>3</sup>/<sub>4</sub>"  
Ø 10,0 mm  
**AK-2154-04**



**COOLEY**  
33,0 cm, 13"  
Ø 8,0 mm  
**AK-2155-01**

Ø 2,0 mm



**COGSWELL**  
23,0 cm, 9"  
**AK-2156-23**

Saugrohre  
Suction Tubes  
Tubos para aspiración  
Tubi aspirazione



**BYRD**  
20,0 cm, 8"

- |          |                   |
|----------|-------------------|
| Ø 1,5 mm | <b>AK-2157-15</b> |
| Ø 2,5 mm | <b>AK-2157-25</b> |
| Ø 3,5 mm | <b>AK-2157-35</b> |



**HEPP/SCHIEDL**  
22,5 cm, 8<sup>3</sup>/<sub>4</sub>"  
**AK-2158-22**

Ø 4,0 mm



**ADSON**  
21,0 cm, 8<sup>1</sup>/<sub>4</sub>"  
**AK-2159-21**



**MAGILL**  
17,5 cm, 6<sup>5</sup>/<sub>8</sub>"

- |          |                   |
|----------|-------------------|
| Ø 1,0 mm | <b>AK-2160-01</b> |
| Ø 2,0 mm | <b>AK-2160-02</b> |
| Ø 3,0 mm | <b>AK-2160-03</b> |
| Ø 4,0 mm | <b>AK-2160-04</b> |



**FRAZIER**  
19,0 cm, 7<sup>1</sup>/<sub>2</sub>"

- |           |                   |
|-----------|-------------------|
| Charr. 6  | <b>AK-2161-06</b> |
| Charr. 8  | <b>AK-2161-08</b> |
| Charr. 10 | <b>AK-2161-10</b> |
| Charr. 12 | <b>AK-2161-12</b> |



**FERGUSON**  
18,0 cm, 7"

- |           |                   |
|-----------|-------------------|
| Charr. 6  | <b>AK-2162-06</b> |
| Charr. 8  | <b>AK-2162-08</b> |
| Charr. 10 | <b>AK-2162-10</b> |
| Charr. 12 | <b>AK-2162-12</b> |



**POPPEN**  
13,0 cm, 5"

- |           |                   |
|-----------|-------------------|
| Charr. 6  | <b>AK-2163-06</b> |
| Charr. 8  | <b>AK-2163-08</b> |
| Charr. 10 | <b>AK-2163-10</b> |
| Charr. 12 | <b>AK-2163-12</b> |

**Galle, Leber, Niere, Blase, Urologie**  
**Gall, Liver, Kidney, Bladder, Urology**  
**Bilis, Hígado, Riñon, Vejiga, Urología**  
**Bile, Fegato, Rene, Vescica, Urologia**



**Nierensteinzangen, Gallensteinzangen**  
**Kidney Stone Forceps, Gall Stone Forceps**  
**Pinzas para los cálculos renales, Pinzas para los cálculos biliares**  
**Pinze per calcoli renali, Pinze per calcoli biliari**



**RANDALL**



23,0 cm, 9"  
**AK-2164-01**

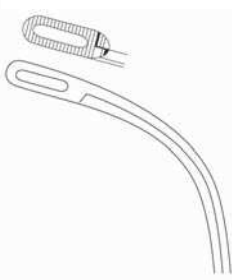

22,0 cm, 8<sup>5</sup>/<sub>8</sub>"  
**AK-2164-02**

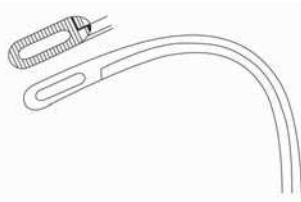

22,0 cm, 8<sup>5</sup>/<sub>8</sub>"  
**AK-2164-03**



22,0 cm, 8<sup>5</sup>/<sub>8</sub>"  
**AK-2164-04**



19,0 cm, 7<sup>1</sup>/<sub>2</sub>"  
**AK-2164-05**

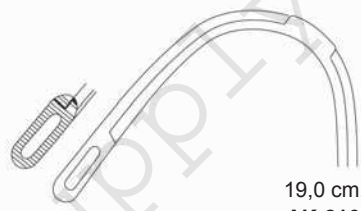

19,0 cm, 7<sup>1</sup>/<sub>2</sub>"  
**AK-2164-06**



**DESJARDINS**  
 23,0 cm, 9"



**AK-2165-01**



**AK-2165-02**



**MIXTER**  
 22,0 cm, 8<sup>5</sup>/<sub>8</sub>"  
**AK-2166-22**



**MAYO BLAKE**  
 20,0 cm, 8"  
**AK-2168-20**



20,0 cm, 8"  
**AK-2169-20**



Gallensteinzangen  
Gall Stone Forceps  
Pinzas para los cálculos biliares  
Pinze per calcoli biliari

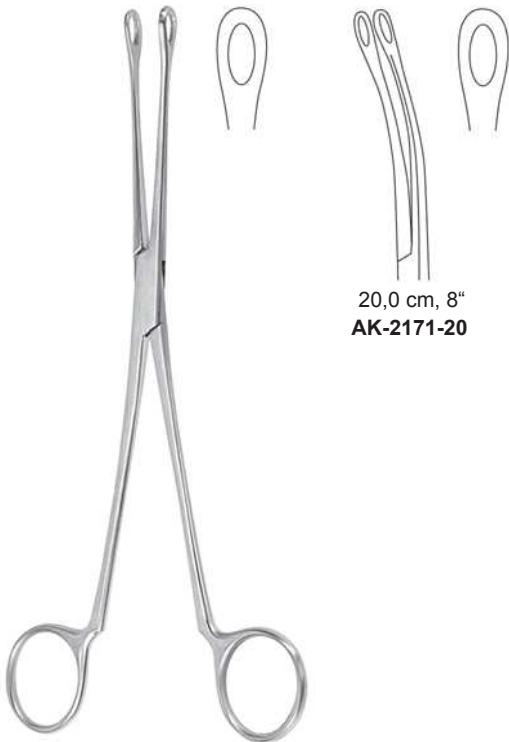

20,0 cm, 8"  
AK-2171-20

**BLAKE**  
20,0 cm, 8"  
AK-2170-20

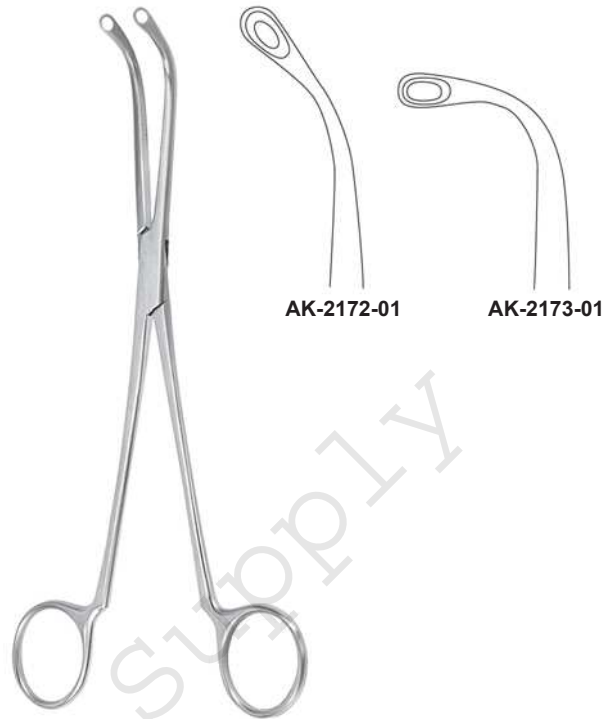

AK-2172-01

AK-2173-01

**TURNER-WARWICK**  
18,0 cm, 7"

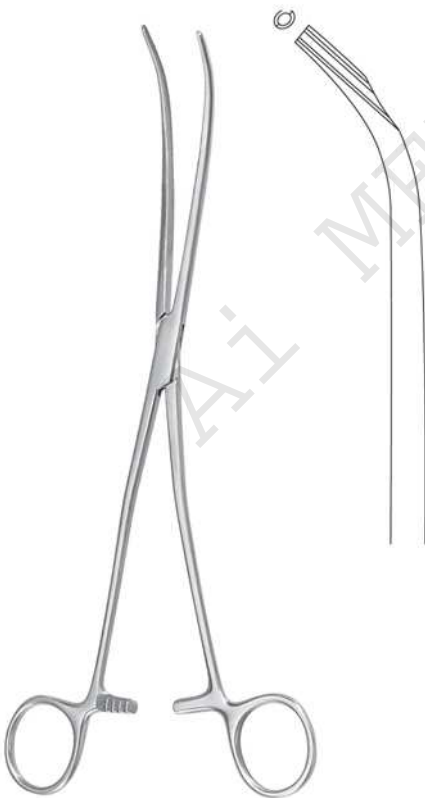

**SÖKELAND**  
24,0 cm, 9<sup>1</sup>/<sub>2</sub>"  
AK-2174-24



**CZERNY**  
24,5 cm, 9<sup>5</sup>/<sub>8</sub>"  
AK-2175-24

**Gallensteinlöffel**  
**Gall Stone Scoops**  
**Cucharillas para los cálculos biliares**  
**Cucchiai per calcoli biliari**



**LUER-KÖRTE**  
 24,0 cm, 9 1/2"

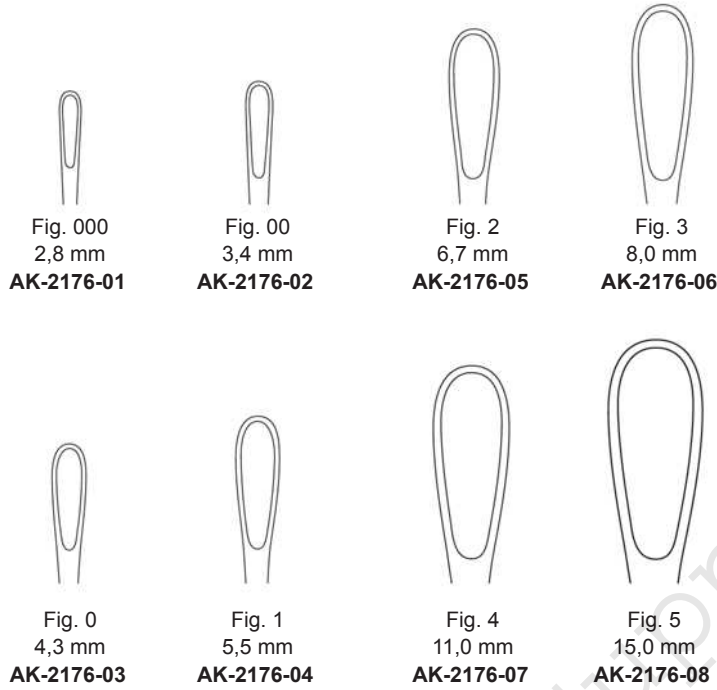

**FERGUSSON**  
 21,5 cm, 8 1/2"  
 AK-2177-01



**MAYO**  
 27,0 cm, 10 5/8"  
 AK-2178-01



**MAYO**  
 27,0 cm, 10 5/8"

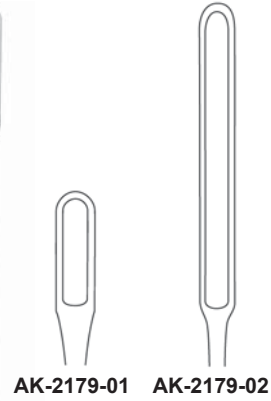

**MOYNIHAN**  
 34,0 cm, 13 3/8"  
 AK-2180-34

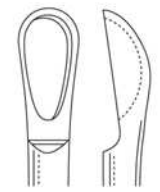

Gallengangsonden, Gallengang Dilatoren  
 Gall Duct Probes, Common Bile Duct Dilators  
 Sonas p. el conducto biliar, Dilatadores para el conducto biliar  
 Dilatori per condotti biliari, Dilatori per coledoco



**MAYO**  
 32,0 cm, 12 1/2"  
 AK-2181-32



**OCHSNER**  
 35,0 cm, 13 3/4"  
 AK-2182-35



**DESJARDINS**  
 28,0 cm, 11"

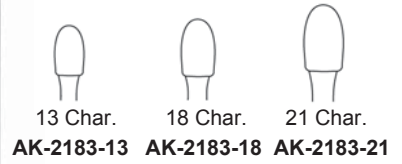

**MOORE**  
 30,0 cm, 12"  
 AK-2185-30

Gallenblasenlöffel  
 Gall bladder scoope  
 Cuccharilla para la vesicula biliar  
 Cucchiaio per colecisti



**DESJARDINS**  
 28,0 cm, 11"

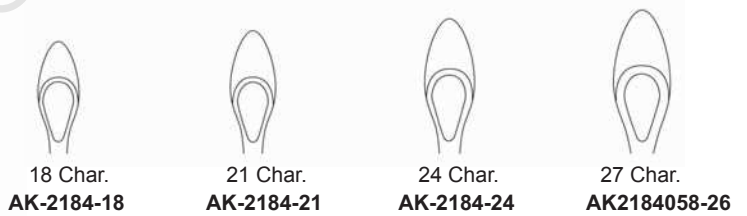

**Gallengang Dilatatoren**  
**Common Bile Duct Dilators**  
**Dilatadores para el conducto biliar**  
**Dilatatori per coledoco**

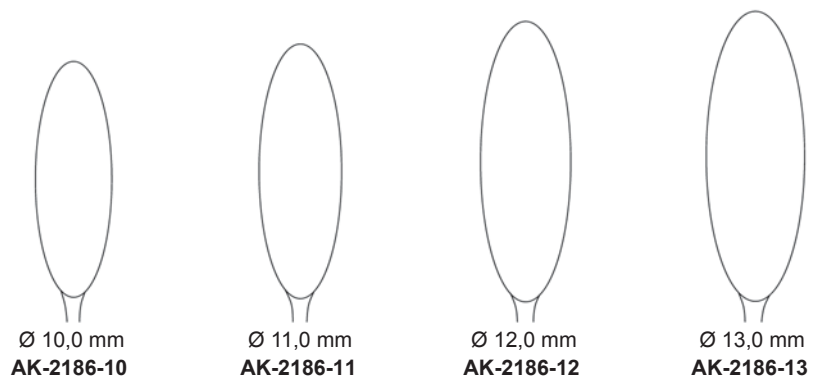
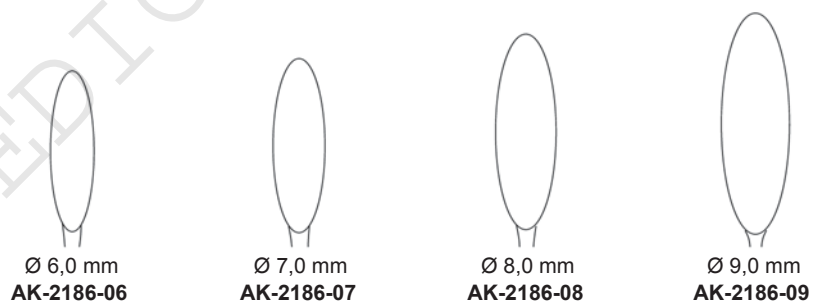
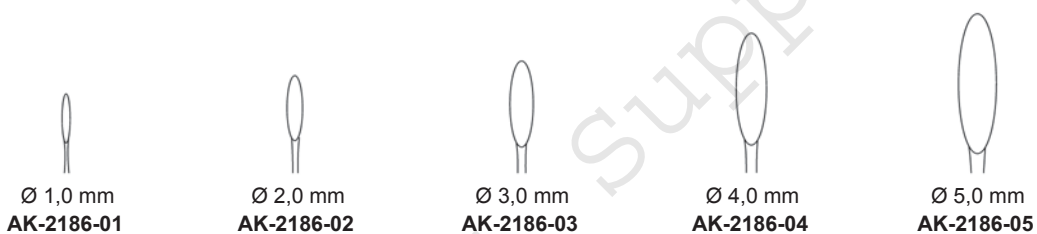

**BAKES**  
30,0 cm, 11<sup>3</sup>/<sub>4</sub>"  
AK-2186-30

**Blasenwundspreizer  
Bladder Retractors  
Deparadores para la vejiga  
Divaricatori vescicali**



Instrumente für Prostatektomie  
 Prostatectomy Instruments  
 Instrumentos para la prostatectomía  
 Strumenti per operazioni della prostata



**MILLIN**  
 23,0 cm, 9"  
 AK-2191-23



**ATRAUMA**

**MILLIN**  
 24,0 cm, 9½"  
 AK-2192-24



**MILLIN**  
 24,0 cm, 9½"  
 AK-2193-24



**MILLIN**  
 23,0 cm, 9"  
 AK-2195-23



**MILLIN**  
 28,5 cm, 11¼"  
 AK-2196-24

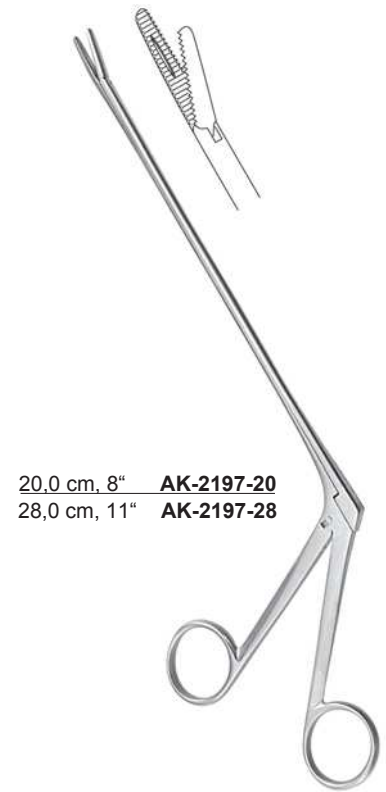

20,0 cm, 8" **AK-2197-20**  
 28,0 cm, 11" **AK-2197-28**

**MATHIEU**

**Prostatahaken, Blasenspatel**  
**Prostatic Retractors, Bladder Retractor**  
**Separadores para la prostata, Separadores vesicales**  
**Retrattori prostatici, Divaricatori vescicali**



**YOUNG**  
 21,0 cm, 8<sup>1</sup>/<sub>4</sub>"  
**AK-2198-21**



**YOUNG**  
 22,0 cm, 8<sup>5</sup>/<sub>8</sub>"  
**AK-2199-22**



**YOUNG**  
 21,0 cm, 8<sup>1</sup>/<sub>4</sub>"  
**AK-2200-21**

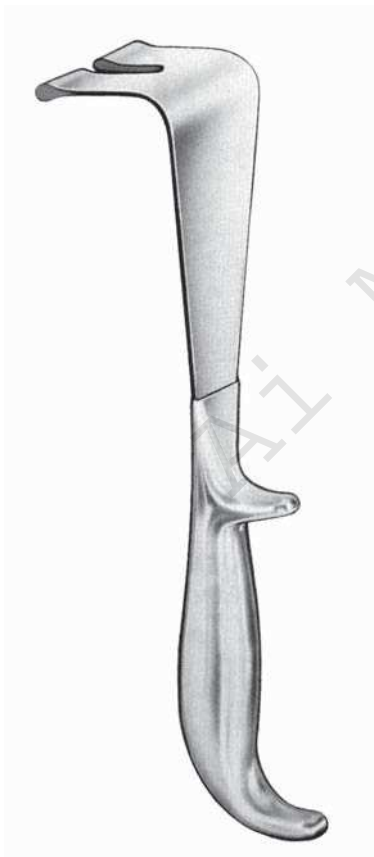

**YOUNG**  
 22,0 cm, 8<sup>5</sup>/<sub>8</sub>"  
**AK-2201-22**



90 x 35 mm

**LEGUEU**  
 26,0 cm, 10<sup>1</sup>/<sub>4</sub>"  
**AK-2202-26**



90 x 61 mm

**KOCHER**  
 23,5 cm, 9<sup>1</sup>/<sub>4</sub>"  
**AK-2203-23**

**Katheter, Penisklemmen**  
**Catheters, Penis Clamp**  
**Sondas, Compresor urétral**  
**Cateteri, Serrapene**



für Männer  
 for men  
 para hombres  
 per uomini

Char. 8	<b>AK-2204-08</b>
Char. 10	<b>AK-2204-10</b>
Char. 12	<b>AK-2204-12</b>
Char. 14	<b>AK-2204-14</b>
Char. 16	<b>AK-2204-16</b>
Char. 18	<b>AK-2204-18</b>
Char. 20	<b>AK-2204-20</b>
Char. 22	<b>AK-2204-22</b>
Char. 24	<b>AK-2204-24</b>

29,0 cm, 11<sup>1</sup>/<sub>2</sub>"



für Frauen  
 for women  
 para mujeres  
 per donne

Char. 6	<b>AK-2205-06</b>
Char. 7	<b>AK-2205-07</b>
Char. 8	<b>AK-2205-08</b>
Char. 9	<b>AK-2205-09</b>
Char. 10	<b>AK-2205-10</b>
Char. 11	<b>AK-2205-11</b>
Char. 12	<b>AK-2205-12</b>
Char. 13	<b>AK-2205-13</b>
Char. 14	<b>AK-2205-14</b>
Char. 15	<b>AK-2205-15</b>
Char. 16	<b>AK-2205-16</b>
Char. 18	<b>AK-2205-18</b>
Char. 20	<b>AK-2205-20</b>
Char. 24	<b>AK-2205-24</b>

16,0 cm, 6<sup>1</sup>/<sub>4</sub>"



**STRAUSS**  
 11,0 cm, 4<sup>1</sup>/<sub>3</sub>"  
**AK-2207-11**



**STOCKMANN**  
 8,0 cm, 3<sup>1</sup>/<sub>4</sub>"  
**AK-2208-08**

Ø 8,0 mm	<b>AK-2206-08</b>
Ø 11,0 mm	<b>AK-2206-11</b>
Ø 13,0 mm	<b>AK-2206-13</b>
Ø 16,0 mm	<b>AK-2206-16</b>
Ø 21,0 mm	<b>AK-2206-21</b>
Ø 26,0 mm	<b>AK-2206-26</b>
Ø 32,0 mm	<b>AK-2206-32</b>



**COMCO**



**Magen, Darm, Mastdarm  
Stomach, Intestines, Rectum  
Estómago, Intestino, Recto  
Stomaco, Intestino, Retto**



**Darm- und Gewebefäßzangen**  
**Intestinal and Tissue Grasping Forceps**  
**Pinzas intestinales y para tejidos**  
**Pinze da presa per intestino e tessuti**

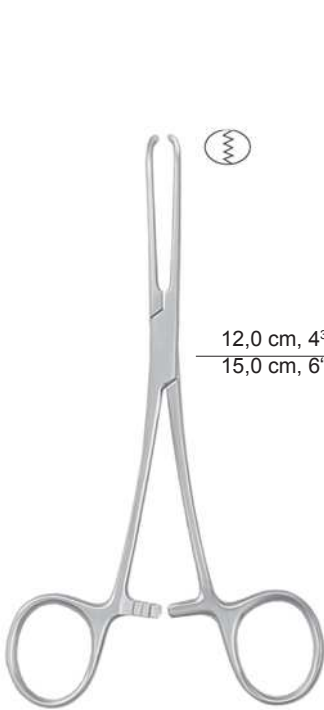

12,0 cm, 4<sup>3</sup>/<sub>4</sub>" **AK-2208-12**  
 15,0 cm, 6" **AK-2208-15**

**ALLIS-BABY**



15,0 cm, 6" **AK-2209-15**  
 19,0 cm, 7<sup>1</sup>/<sub>2</sub>" **AK-2209-19**  
 25,0 cm, 9<sup>3</sup>/<sub>4</sub>" **AK-2209-25**

**ALLIS**

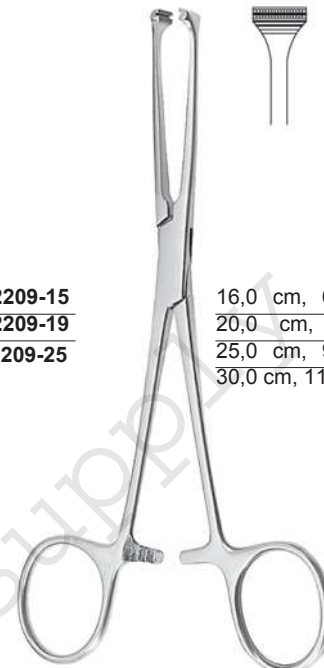

16,0 cm, 6<sup>1</sup>/<sub>4</sub>" **AK-2210-16**  
 20,0 cm, 8" **AK-2210-20**  
 25,0 cm, 9<sup>3</sup>/<sub>4</sub>" **AK-2210-25**  
 30,0 cm, 11<sup>3</sup>/<sub>4</sub>" **AK-2210-30**

**ALLIS-ATRAUMA**



15,5 cm, 6" **AK-2211-15**  
 20,0 cm, 8" **AK-2211-20**  
 23,0 cm, 9" **AK-2211-23**

**ALLEN**



12,5 cm, 5" **AK-2212-12**  
 15,0 cm, 6" **AK-2212-15**  
 19,5 cm, 7<sup>3</sup>/<sub>4</sub>" **AK-2212-19**

**LANE**

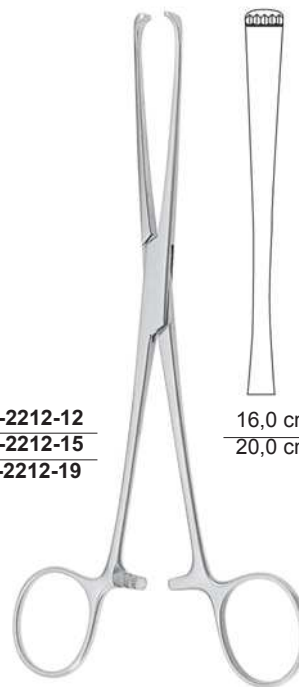

16,0 cm, 6<sup>1</sup>/<sub>4</sub>" **AK-2213-16**  
 20,0 cm, 8" **AK-2213-20**

**LOCKWOOD-ALLIS**

Darm- und Gewebefäßzangen  
 Intestinal and Tissue Grasping Forceps  
 Pinzas intestinales y para tejidos  
 Pinze da presa per intestino e tessuti



15,0 cm, 6" **AK-2214-15**  
 19,0 cm, 7½" **AK-2214-19**

**JUDD-ALLIS**



**LITTLEWOOD**  
 18,5 cm, 7¼"  
**AK-2215-16**



**ALLIS-ADAIR**  
 15,5 cm, 6"  
**AK-2216-15**



**BOYS-ALLIS**  
 15,5 cm, 6"  
**AK-2217-15**



**THOMS-ALLIS**  
 20,0 cm, 8"  
**AK-2218-20**



**ALLIS**  
 20,0 cm, 8"  
**AK-2219-20**

**Darm- und Gewebefäßzangen**  
**Intestinal and Tissue Grasping Forceps**  
**Pinzas intestinales y para tejidos**  
**Pinze da presa per intestino e tessuti**



**LOCKWOOD**  
 20,0 cm, 8"  
**AK-2220-20**



**WILLIAMS**  
 16,0 cm, 6 1/4"  
**AK-2221-16**



16,0 cm, 6 1/4" **AK-2222-16**  
 18,0 cm, 7" **AK-2222-18**  
 20,0 cm, 8" **AK-2222-20**  
 24,0 cm, 9 1/2" **AK-2222-24**

**BABCOCK**



16,0 cm, 6 1/4" **AK-2223-16**  
 20,0 cm, 8" **AK-2223-20**

**BABCOCK-ATRAUMA**



16,0 cm, 6 1/4" **AK-2224-16**  
 20,0 cm, 8" **AK-2224-20**

**BABCOCK-TC**



**DUVAL-TC**  
 20,0 cm, 8"  
**AK-2225-20**

Darmklemmen  
 Intestinal Clamp Forceps  
 Pinzas-clamps intestinales  
 Pinze intestinali

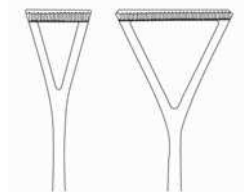

18,0 cm, 7" **AK-2226-18**  
 20,0 cm, 8" **AK-2226-20 AK-2227-20**  
 23,0 cm, 9" **AK-2227-23**

Darm- und Gewebefaßzangen  
 Intestinal and Tissue Grasping Forceps  
 Pinzas intestinales y para tejidos  
 Pinze da presa per intestino e tessuti

**DUVAL**

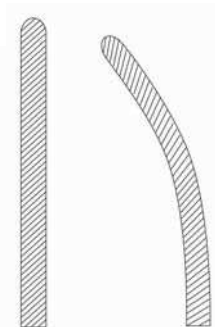

**AK-2228-18** **AK-2229-18**

**BABY-DOYEN**  
 18,0 cm, 7"

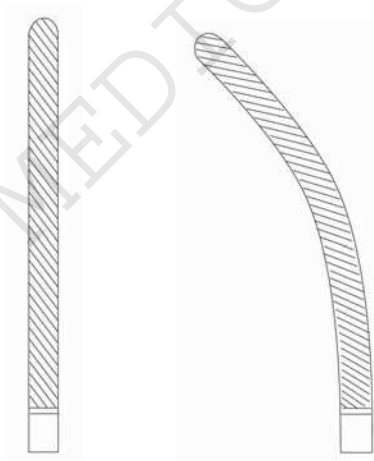

21,0 cm, 8 1/4" **AK-2230-21** **AK-2231-21**  
 23,0 cm, 9" **AK-2230-23** **AK-2231-23**

**DOYEN**

**Darmklemmen**  
**Intestinal Clamp Forceps**  
**Pinzas-clamps intestinales**  
**Pinze intestinali**



**DOYEN**



21,0 cm, 8<sup>1</sup>/<sub>4</sub>" **AK-2232-21**  
 23,0 cm, 9" **AK-2232-23**



21,0 cm, 8<sup>1</sup>/<sub>4</sub>" **AK-2233-21**  
 23,0 cm, 9" **AK-2233-23**

mit atraumatischer Zahnung  
 with atraumatic serration  
 con bacos atraumáticos  
 con morsi atraumatici



**KOCHER**



22,0 cm, 8<sup>5</sup>/<sub>8</sub>" **AK-2234-22**  
 25,0 cm, 9<sup>3</sup>/<sub>4</sub>" **AK-2234-25**  
 28,0 cm, 11" **AK-2234-28**



22,0 cm, 8<sup>5</sup>/<sub>8</sub>" **AK-2235-22**  
 25,0 cm, 9<sup>3</sup>/<sub>4</sub>" **AK-2235-25**  
 28,0 cm, 11" **AK-2235-28**



mit atraumatischer Zahnung  
 with atraumatic serration  
 con bacos atraumáticos  
 con morsi atraumatici

**KOCHER**



22,0 cm, 8<sup>5</sup>/<sub>8</sub>" **AK-2236-22**  
 25,0 cm, 9<sup>3</sup>/<sub>4</sub>" **AK-2236-25**  
 28,0 cm, 11" **AK-2236-28**



22,0 cm, 8<sup>5</sup>/<sub>8</sub>" **AK-2237-22**  
 25,0 cm, 9<sup>3</sup>/<sub>4</sub>" **AK-2237-25**  
 28,0 cm, 11" **AK-2237-28**



**MAYO-ROBSON**



21,0 cm, 8<sup>1</sup>/<sub>4</sub>" **AK-2238-21**  
 23,0 cm, 9" **AK-2238-23**  
 25,0 cm, 9<sup>3</sup>/<sub>4</sub>" **AK-2238-25**



21,0 cm, 8<sup>1</sup>/<sub>4</sub>" **AK-2239-21**  
 23,0 cm, 9" **AK-2239-23**  
 25,0 cm, 9<sup>3</sup>/<sub>4</sub>" **AK-2239-25**

**Darmklemmen**  
**Intestinal Clamp Forceps**  
**Pinzas-clamps intestinales**  
**Pinze intestinali**



21,0 cm, 8 1/4"	<b>AK-2240-21</b>
23,0 cm, 9"	<b>AK-2240-23</b>
25,0 cm, 9 3/4"	<b>AK-2240-25</b>

mit atraumatischer Zahnung  
with atraumatic serration  
con bacos atraumáticos  
con morsi atraumatici

**MAYO-ROBSON**

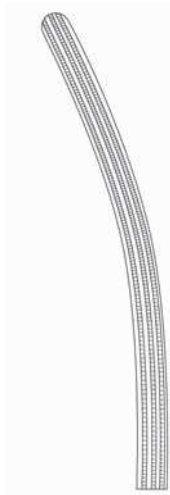

21,0 cm, 8 1/4"	<b>AK-2241-21</b>
23,0 cm, 9"	<b>AK-2241-23</b>
25,0 cm, 9 3/4"	<b>AK-2241-25</b>

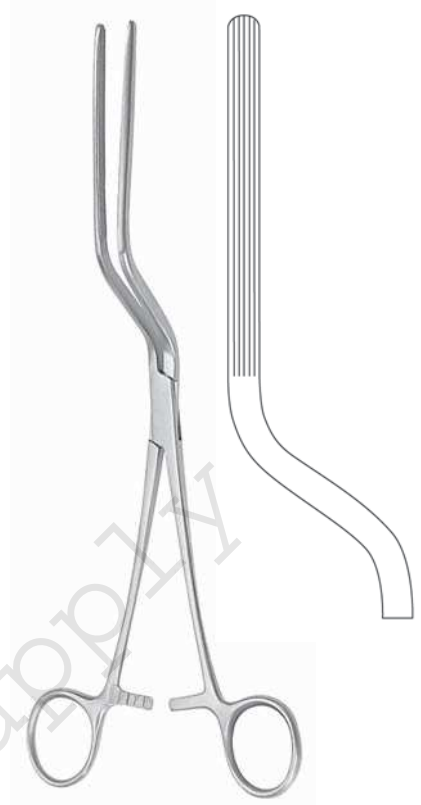

**BRUNNER**  
24,0 cm, 9 1/2"  
**AK-2242-24**

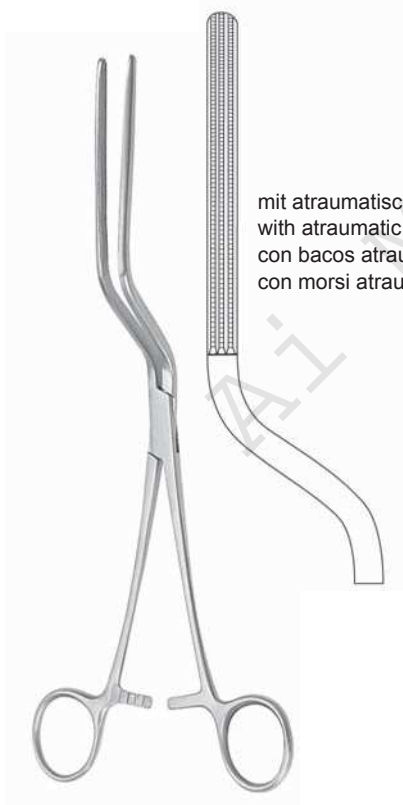

mit atraumatischer Zahnung  
with atraumatic serration  
con bacos atraumáticos  
con morsi atraumatici

**BRUNNER**  
24,0 cm, 9 1/2"  
**AK-2243-24**



**GLASSMAN**  
23,0 cm, 9"  
**AK-2244-23**



**GLASSMAN**  
23,5 cm, 9 1/4"  
**AK-2245-23**



Darm- und Magenquetschklemmen  
 Intestinal and Stomach Clamps  
 Pinzas-clamps intestinales y estomacales  
 Pinze/Clamp per intestino e stomaco



Maullänge  
 length of jaws  
 longitud de la boca  
 bocche lungh.

5,0 cm, 2" **AK-2246-05**  
 7,0 cm, 2 1/2" **AK-2246-07**  
 10,0 cm, 4" **AK-2246-10**

**DE MARTEL-WOLFSON**



**DE MARTEL-WOLFSON**  
 8,5 cm, 3 1/2"  
**AK-2247-08**



**DE MARTEL-WOLFSON**  
 26,0 cm, 10 1/4"  
**AK-2248-26**



**BABY-PAYR**  
 15,0 cm, 6"



**AK-2249-15**  
 mit Stift  
 with pin  
 con espiga  
 con perno



**AK-2250-15**  
 ohne Stift  
 without pin  
 sin espiga  
 senza perno



**PAYR**



21,0 cm, 8 1/4" **AK-2252-21** **AK-2253-21**  
 29,0 cm, 11 1/2" **AK-2252-29** **AK-2253-29**



mit Stift  
 with pin  
 con espiga  
 con perno

ohne Stift  
 without pin  
 sin espiga  
 senza perno

Darm- und Magenklappen  
 Intestinal and Stomach Clamp Forceps  
 Pinzas-clamps intestinales y estomacales  
 Pinze per intestino e stomaco



AK-2254-30

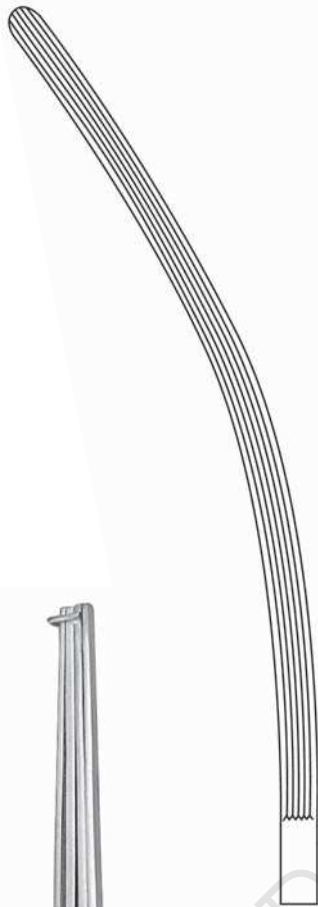

AK-2255-30

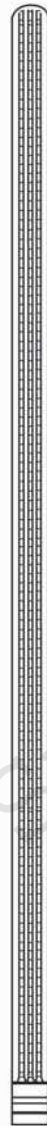

AK-2256-33



AK-2257-33

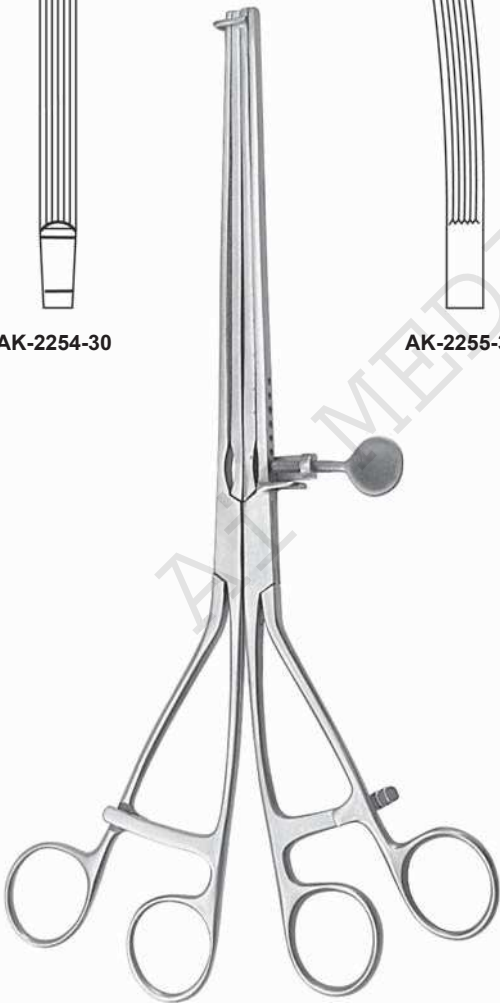

**LANE**  
 30,0 cm, 11<sup>3</sup>/<sub>4</sub>"

mit atraumatischer Zahnung  
 with atraumatic serration  
 con bacos atraumáticas  
 con morsi atraumatici



**SCUDDER**  
 33,0 cm, 13"

Rektum-Anastomosenklemmen  
Sigmoid Anastomosis Forceps  
Pinzas para anastomosis de recto  
Pinze per anastomosi de retto



**MIKULICZ**  
19,0 cm, 7 1/2"  
AK-2258-19

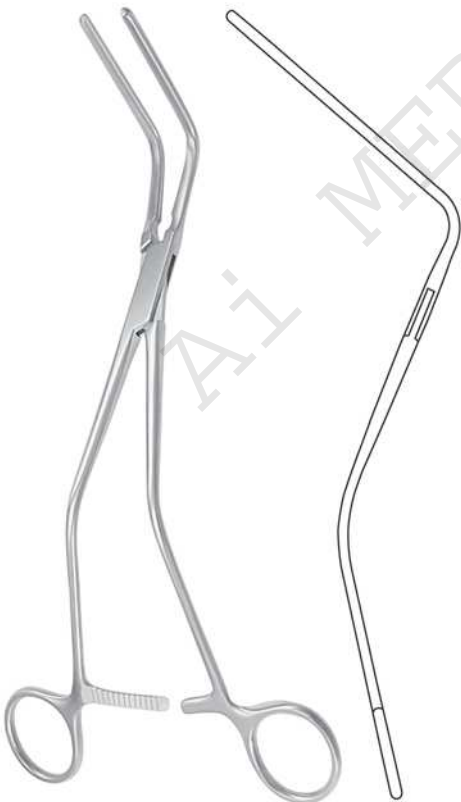
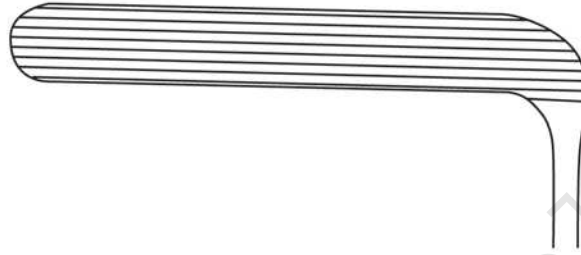

**HAYES**

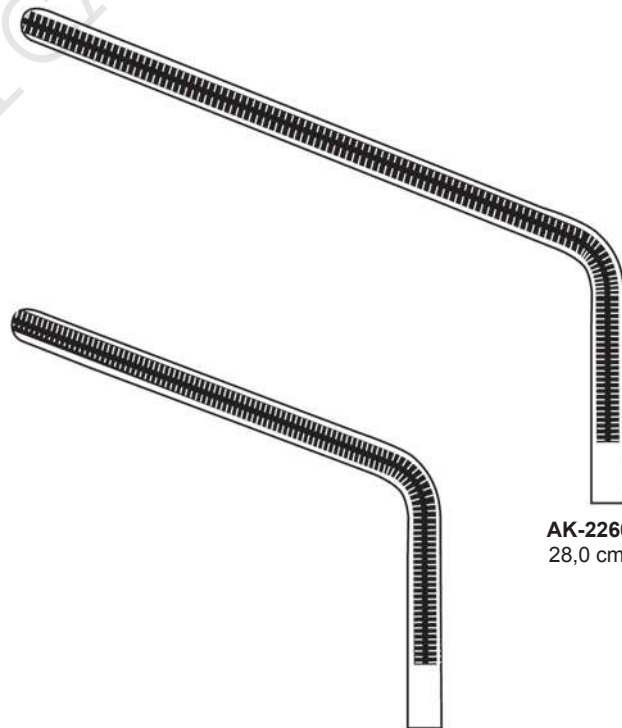

**AK-2259-26**  
26,0 cm, 10"

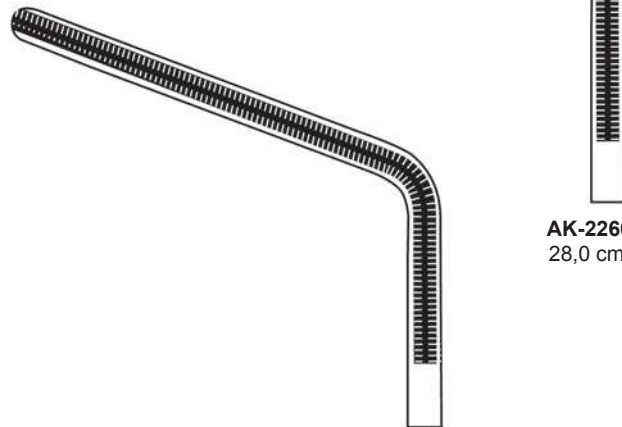

**AK-2260-28**  
28,0 cm, 11"

**Mastdarm-Rektum-Spekula**  
**Rectal Specula**  
**Espéculos para el recto**  
**Speculi rectali**

17 x 89 mm



**SIMS**  
15,0 cm, 6"  
**AK-2261-15**

17 x 89 mm



**SIMS**  
15,0 cm, 6"  
**AK-2262-15**

25 x 89 mm



**MATHIEU**  
21,0 cm, 8 1/4"  
**AK-2263-21**

75 x 23 mm



**SMITH-BUIE**  
15,0 cm, 6"  
**AK-2264-15**

**Anal spreizer, Sphinkteroskope, Anuskope**  
**Rectal Retractor, Sphincteroscopes, Anoscope**  
**Separadores para el recto, Esfinteroscopios, Anoscopios**  
**Dilatatori per l'ano ed il retti, Sfinteroscopi, Anoscopi**

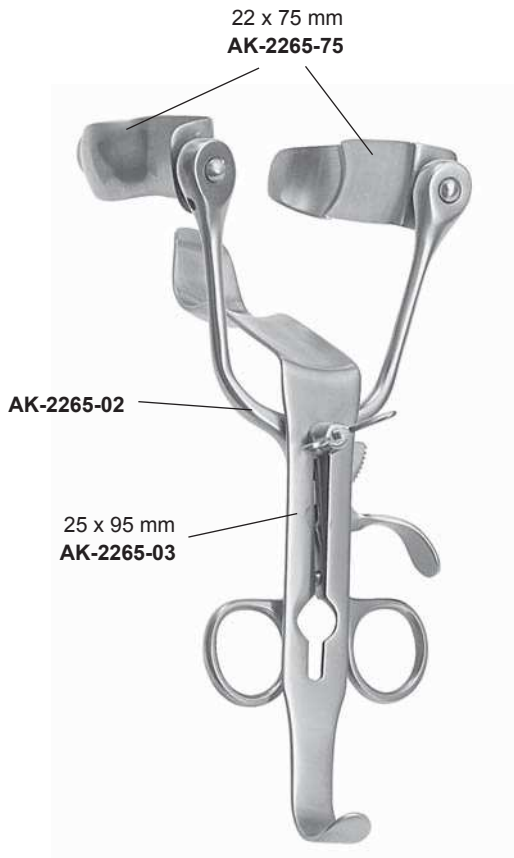

**ALAN PARKS**  
 13,5 cm, 5<sup>3</sup>/<sub>8</sub>"  
**AK-2265-00**



Kaltlichtkammer für Proktoskope  
 Cold-light clip for proctoscopes  
 Clip para luz fría con proctoscopios  
 Clip per luce fredda con protoscopi

**AK-2266-00**

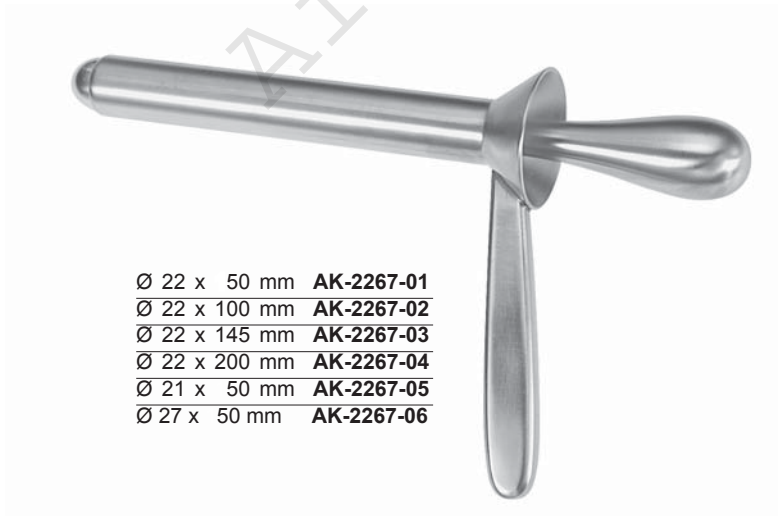

- Ø 22 x 50 mm **AK-2267-01**
- Ø 22 x 100 mm **AK-2267-02**
- Ø 22 x 145 mm **AK-2267-03**
- Ø 22 x 200 mm **AK-2267-04**
- Ø 21 x 50 mm **AK-2267-05**
- Ø 27 x 50 mm **AK-2267-06**

**HAYES**



- Ø 16 x 65 mm **AK-2268-01**
- Ø 19 x 65 mm **AK-2268-02**
- Ø 22 x 65 mm **AK-2268-03**
- Ø 22 x 130 mm **AK-2268-04**

**HIRSCHMANN**

Anuskope, Proktoskope  
 Anoscope, Proctoscopes  
 Anoscopios, Proctoscopios  
 Anoscopi, Protoscopi



Ø 22 x 65 mm **AK-2269-22**  
 Ø 30 x 65 mm **AK-2269-30**

**CHELSEA EATON**



ohne Kaltlichtträger  
 without cold light carrier  
 sin portador para luz fría  
 senza luce fredda

mit Kaltlichtträger  
 with cold light carrier  
 con portador para luz fría  
 con luce fredda

**IVES FANSLER**  
 Ø 22 mm  
**AK-2270-01**

**IVES FANSLER**  
 Ø 22 mm  
**AK-2271-02**



Ø 17 x 65 mm **AK-2272-01**  
 Ø 17 x 80 mm **AK-2272-02**  
 Ø 20 x 65 mm **AK-2272-03**  
 Ø 20 x 80 mm **AK-2272-04**  
 Ø 24 x 65 mm **AK-2272-05**  
 Ø 24 x 80 mm **AK-2272-06**

055-1000-02

**MORGAN**



Ø 25 x 65 mm **AK-2273-25**  
 Ø 29 x 65 mm **AK-2273-29**  
 Ø 38 x 70 mm **AK-2273-38**

**FANSLER**

**Mastdarm-Biopsiezangen**  
**Rectal Biopsy Forceps**  
**Pinzas sacabocado para biopsia rectal**  
**Pinze taglianti per biopsia rettale**



28,0 cm, 11" **AK-2274-28**  
 35,0 cm, 13<sup>3</sup>/<sub>4</sub>" **AK-2274-35**  
 42,0 cm, 16<sup>1</sup>/<sub>2</sub>" **AK-2274-42**

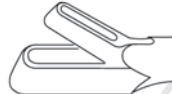

28,0 cm, 11" **AK-2275-28**  
 35,0 cm, 13<sup>3</sup>/<sub>4</sub>" **AK-2275-35**  
 42,0 cm, 16<sup>1</sup>/<sub>2</sub>" **AK-2275-42**

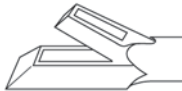

28,0 cm, 11" **AK-2276-28**  
 35,0 cm, 13<sup>3</sup>/<sub>4</sub>" **AK-2276-35**  
 42,0 cm, 16<sup>1</sup>/<sub>2</sub>" **AK-2276-42**



28,0 cm, 11" **AK-2277-28**  
 35,0 cm, 13<sup>3</sup>/<sub>4</sub>" **AK-2277-35**  
 42,0 cm, 16<sup>1</sup>/<sub>2</sub>" **AK-2277-42**



**AK-2278-00**

Ø 12,0 mm

Hämorrhoiden-Ligator mit Ladekonus  
 Haemorrhoidal ligator with loading attachment  
 Ligador para hemorroides con cono de carga  
 Legatori emorroidali con carica a cono

**RUDD**  
**AK-2280-00**

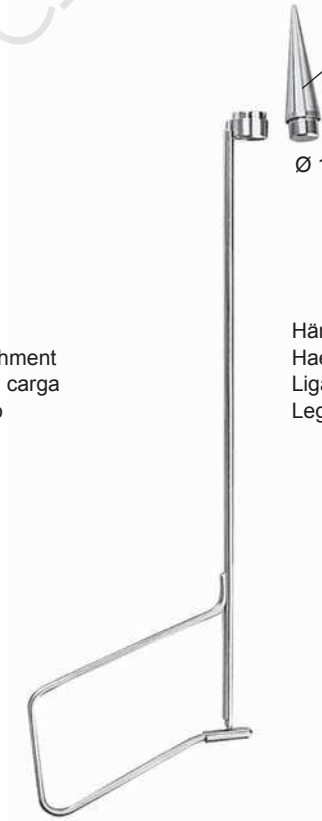

**AK-2279-00**

Ø 12,0 mm

Hämorrhoiden-Ligator mit Ladekonus  
 Haemorrhoidal ligator with loading attachment  
 Ligador para hemorroides con cono de carga  
 Legatori emorroidali con carica a cono

**MC GIVNEY**  
**AK-2281-00**

Hämorrhoiden-Faßzangen, Fistelsonden  
Haemorrhoidal Forceps, Fistula probes  
Pinza-clamps para hemorroides, Sondas para fistula  
Pinze ner emorroidi. Sonde ner fistola



**MC GIVNEY**  
19,0 cm, 7½"  
**AK-2282-19**



**MC GIVNEY**  
19,0 cm, 7½"  
**AK-2283-19**



**PRATT**  
21,0 cm, 8¼"



**AK-2284-01**



**AK-2284-02**



**AK-2284-03**



**Gynäkologie, Geburtshilfe**  
**Gynecology, Obstetrics**  
**Ginecología, Obstetricia**  
**Ginecologia, Ostetricia**



Scheidenspekula  
 Vaginal Specula  
 Espéculos vaginales  
 Speculi vaginali

für Kinder  
 for children  
 para niños  
 per bambini



**COLLIN**  
 65 x 10 mm  
 AK-2285-00

für Jungfrauen  
 for virgins  
 para virgenes  
 per vergini

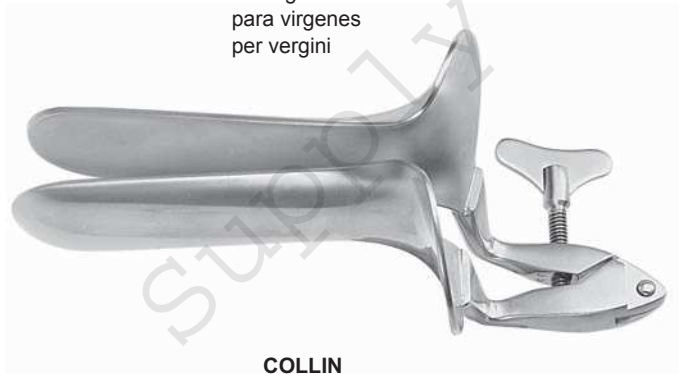

**COLLIN**  
 65 x 10 mm  
 AK-2286-00



**COLLIN**

85 x 30 mm	AK-2287-01
100 x 35 mm	AK-2287-02
110 x 40 mm	AK-2287-03



**CUSCO**

80 x 24 mm	AK-2288-01
80 x 32 mm	AK-2288-02
98 x 16 mm	AK-2288-03
105 x 25 mm	AK-2288-04
107 x 29 mm	AK-2288-05
115 x 35 mm	AK-2288-06



zentrale Stellschraube  
 central fixation screw  
 tornillo de sujeto central  
 vite di regolazione centrale

CUSCO	
75 x 32 mm	<b>AK-2289-01</b>
85 x 36 mm	<b>AK-2289-02</b>
95 x 37 mm	<b>AK-2289-03</b>



seitliche Stellschraube  
 lateral fixation screw  
 tornillo de sujeto lateral  
 vite di regolazione laterale

für Jungfrauen  
 for virgins  
 para virgenes  
 per vergini

CUSCO	
75 x 17 mm	<b>AK-2290-00</b>



seitliche Stellschraube  
 lateral fixation screw  
 tornillo de sujeto lateral  
 vite di regolazione laterale

CUSCO	
75 x 32 mm	<b>AK-2291-01</b>
85 x 35 mm	<b>AK-2291-02</b>
100 x 35 mm	<b>AK-2291-03</b>



Schweizer Modell  
 Swiss pattern  
 Modelo suizo  
 Modello svizzero

CUSCO	
90 x 23-25 mm	<b>AK-2292-01</b>
100 x 25-27 mm	<b>AK-2292-02</b>
110 x 27-30 mm	<b>AK-2292-03</b>

Scheidenspekula  
 Vaginal Specula  
 Espéculos vaginales  
 Speculi vaginali



**GRAVE**

75 x 20 mm	<b>AK-2293-01</b>
95 x 35 mm	<b>AK-2293-02</b>
115 x 35 mm	<b>AK-2293-03</b>



**PEDERSON**

75 x 13 mm	<b>AK-2294-01</b>
100 x 22 mm	<b>AK-2294-02</b>
120 x 25 mm	<b>AK-2294-03</b>



**SEMM**

90 x 14-18 mm	<b>AK-2295-01</b>
100 x 17-20 mm	<b>AK-2295-02</b>
100 x 25-30 mm	<b>AK-2295-03</b>



**WEISSBARTH**

21,0 cm, 8 1/4"  
**AK-2296-00**



mit abnehmbarem Gewicht  
 with detachable weight  
 con peso desmontable  
 con peso smontabile

1,14 kg

**AUVARD**  
 75 x 38 mm  
 AK-2297-00



mit festem Gewicht  
 with fixed weight  
 con peso fijo  
 con peso fisso

1,14 kg

**AUVARD**  
 75 x 38 mm  
 AK-2298-00



AK-2299-03

400 g

AK-2299-40

800 g

AK-2299-80

**SCHERBACK**  
 AK-2299-00

koplett, complete, completo, completo



80 x 30 mm  
 AK-2299-04



85 x 35 mm  
 AK-2299-05



85 x 40 mm  
 AK-2299-06



55 x 40-60 mm  
 AK-2299-07

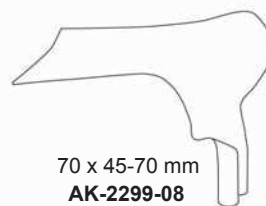

70 x 45-70 mm  
 AK-2299-08

Scheidenspekula  
 Vaginal Specula  
 Espéculos vaginales  
 Speculi vaginali



Satz  
 Set  
 Juego  
 Set

**KRISTELLER**  
 Fig. 1 **AK-2300-01**  
 Fig. 2 **AK-2300-02**  
 Fig. 3 **AK-2300-03**



Spekula allein, flach  
 Specula only, flat hollow  
 Espéculos suelto, con huecos planos  
 Solo speculi, piatta

**KRISTELLER**  
 105 x 26 mm **AK-2301-01**  
 105 x 28 mm **AK-2301-02**  
 105 x 33 mm **AK-2301-03**

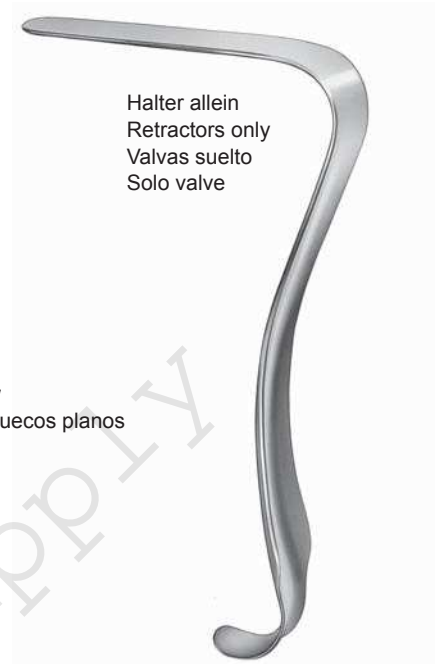

Halter allein  
 Retractors only  
 Valvas suelto  
 Solo valve

**KRISTELLER**  
 115 x 22 mm **AK-2302-01**  
 115 x 24 mm **AK-2302-02**  
 115 x 29 mm **AK-2302-03**



Satz  
 Set  
 Juego  
 Set

**KRISTELLER**  
 Fig. 1 **AK-2303-01**  
 Fig. 2 **AK-2303-02**  
 Fig. 3 **AK-2303-03**



Spekula allein, flach  
 Specula only, flat hollow  
 Espéculos suelto, con huecos planos  
 Solo speculi, piatta

**KRISTELLER**  
 110 x 27 mm **AK-2304-01**  
 110 x 30 mm **AK-2304-02**  
 110 x 36 mm **AK-2304-03**

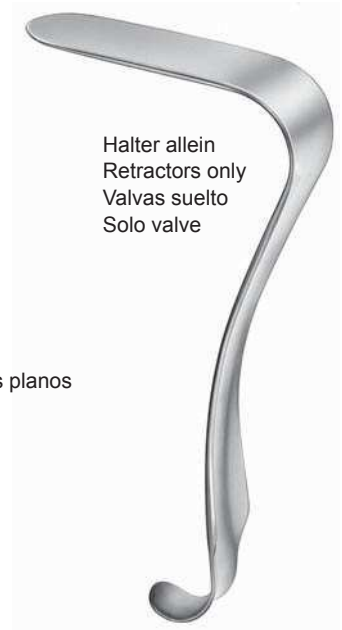

Halter allein  
 Retractors only  
 Valvas suelto  
 Solo valve

**KRISTELLER**  
 115 x 23 mm **AK-2305-01**  
 115 x 26 mm **AK-2305-02**  
 115 x 32 mm **AK-2305-03**

Scheidenspekula  
Vaginal Specula  
Espéculos vaginales  
Speculi vaginali



Satz  
Set  
Juego  
Set

**KRISTELLER**

Fig. 0 **AK-2306-00**  
Fig. 1 **AK-2306-01**  
Fig. 2 **AK-2306-02**  
Fig. 3 **AK-2306-03**



Spekula allein  
Specula only  
Espéculos suelto  
Solo speculi

**KRISTELLER**

70 x 15 mm **AK-2307-00**  
70 x 27 mm **AK-2307-01**  
80 x 30 mm **AK-2307-02**  
90 x 36 mm **AK-2307-03**

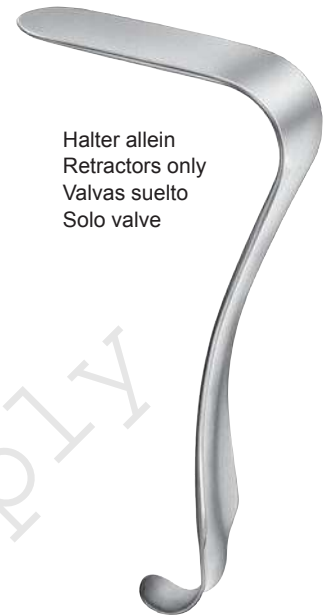

Halter allein  
Retractors only  
Valvas suelto  
Solo valve

**KRISTELLER**

75 x 10 mm **AK-2308-00**  
75 x 23 mm **AK-2308-01**  
85 x 26 mm **AK-2308-02**  
100 x 32 mm **AK-2308-03**



konisch, für Jungfrauen  
conical blades, for virgins  
valvos cónicos, para vírgenes  
valve coniche, per vergini

Satz  
Set  
Juego  
Set

**KRISTELLER**

Fig. 00 **AK-2309-01**  
Fig. 0 **AK-2309-02**



Spekula allein  
Specula only  
Espéculos suelto  
Solo speculi

**KRISTELLER**

105 x 18 mm **AK-2310-01**  
105 x 21 mm **AK-2310-02**



Halter allein  
Retractors only  
Valvas suelto  
Solo valve

**KRISTELLER**

110 x 14 mm **AK-2311-01**  
110 x 17 mm **AK-2311-02**

Scheidenspekula  
 Vaginal Specula  
 Espéculos vaginales  
 Speculi vaginali



leicht hohl  
 slightly-concave  
 ligeremente concavos  
 leggeremente concavi

**DOYEN**  
 23,0 cm, 9"

Fig	a x b	
1	55 x 35 mm	<b>AK-2312-01</b>
2	85 x 35 mm	<b>AK-2312-02</b>
3	115 x 35 mm	<b>AK-2312-03</b>

1	55 x 45 mm	<b>AK-2313-01</b>
2	85 x 45 mm	<b>AK-2313-02</b>
3	115 x 45 mm	<b>AK-2313-03</b>
4	160 x 45 mm	<b>AK-2313-04</b>

1	55 x 60 mm	<b>AK-2314-01</b>
2	85 x 60 mm	<b>AK-2314-02</b>
3	115 x 60 mm	<b>AK-2314-03</b>
4	160 x 60 mm	<b>AK-2314-04</b>

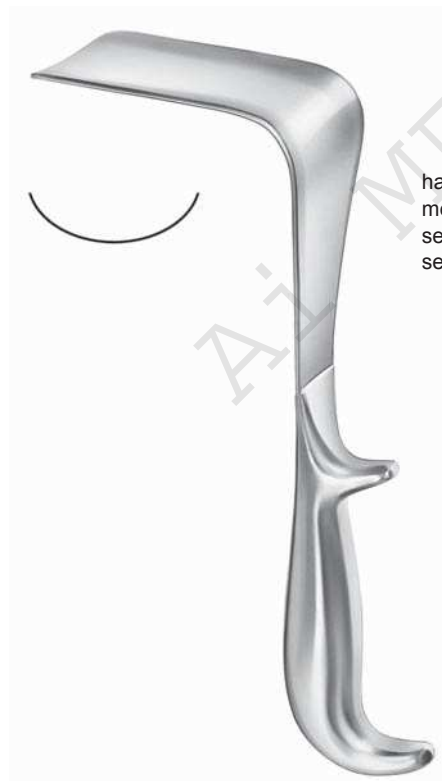

halb-hohl  
 medium-concave  
 semi-concavos  
 semi-concavi

**DOYEN**  
 23,0 cm, 9"

Fig	a x b	
1	55 x 35 mm	<b>AK-2315-01</b>
2	85 x 35 mm	<b>AK-2315-02</b>
3	115 x 35 mm	<b>AK-2315-03</b>

1	55 x 45 mm	<b>AK-2316-01</b>
2	85 x 45 mm	<b>AK-2316-02</b>
3	115 x 45 mm	<b>AK-2316-03</b>

1	55 x 60 mm	<b>AK-2317-01</b>
2	85 x 60 mm	<b>AK-2317-02</b>
3	115 x 60 mm	<b>AK-2317-03</b>



Scheidenspekula  
Vaginal Specula  
Espéculos vaginales  
Speculi vaginali



Satz  
Set  
Juego  
Set

**KALLMORGEN**  
70 x 40 mm **AK-2318-01**  
90 x 40 mm **AK-2318-02**



Spekula allein  
Specula only  
Espéculos suelto  
Solo speculi

**KALLMORGEN**  
70 x 40 mm **AK-2319-01**  
90 x 40 mm **AK-2319-02**



Halter allein  
Retractors only  
Valvas suelto  
Solo valve

**KALLMORGEN**  
70 x 40 mm **AK-2320-01**  
90 x 40 mm **AK-2320-02**



70 x 15 mm

**KRISTELLER**  
17,0 cm, 6<sup>3</sup>/<sub>4</sub>"  
**AK-2321-17**



75 x 39 mm

**KALLMORGEN**  
17,0 cm, 6<sup>3</sup>/<sub>4</sub>"  
**AK-2322-17**



**JACKSON**  
75 x 38 mm **AK-2323-01**  
90 x 38 mm **AK-2323-02**  
100 x 38 mm **AK-2323-03**

Scheidenspekula  
Vaginal Specula  
Espéculos vaginales  
Speculi vaginali

76 x 25 mm



70 x 22 mm

**BREISKY**  
14,0 cm, 5½"  
**AK-2324-01**

82 x 30 mm



76 x 25 mm

**BREISKY**  
14,0 cm, 5½"  
**AK-2324-02**

95 x 38 mm



82 x 30 mm

**BREISKY**  
17,0 cm, 6¾"  
**AK-2324-03**

102 x 44 mm



95 x 38 mm

**BREISKY**  
17,0 cm, 6¾"  
**AK-2324-04**

Scheidenspekula und -halter  
 Vaginal Specula and Retractors  
 Espéculos y valvas vaginales  
 Speculi e valve vaginali

**SIMS**  
**GO-1294-00**  
 Satz, Set, Juego, Set

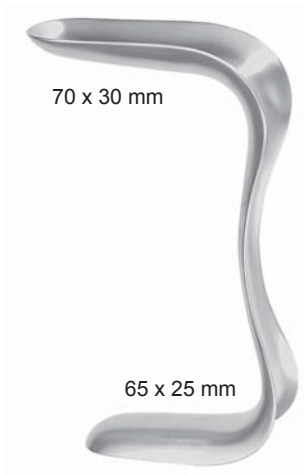

70 x 30 mm

65 x 25 mm

**SIMS**  
 12,5 cm, 5"  
**AK-2325-01**



70 x 35 mm

70 x 30 mm

**SIMS**  
 15,0 cm, 6"  
**AK-2325-02**



90 x 40 mm

85 x 35 mm

**SIMS**  
 17,5 cm, 7"  
**AK-2325-03**



Spekula allein  
 Specula only  
 Espéculos suelto  
 Solo speculi

**MATHIEU**  
 100 x 13-23 mm **AK-2326-01**  
 100 x 16-30 mm **AK-2326-02**



Halter allein  
 Retractors only  
 Valvas suelto  
 Solo valve

**MATHIEU**  
 100 x 11-21 mm **AK-2327-01**  
 100 x 14-27 mm **AK-2327-02**



**LANDAU**  
 100 x 28 mm **AK-2328-01**  
 100 x 38 mm **AK-2328-02**

Scheidenspekula  
 Vaginal Specula  
 Espéculos vaginales  
 Speculi vaginali



- 100 x 20 mm **AK-2329-20**
  - 100 x 25 mm **AK-2329-25**
  - 100 x 30 mm **AK-2329-30**
  - 100 x 35 mm **AK-2329-35**
  - 100 x 40 mm **AK-2329-40**
- 
- 130 x 20 mm **AK-2330-20**
  - 130 x 25 mm **AK-2330-25**
  - 130 x 30 mm **AK-2330-30**
  - 130 x 35 mm **AK-2330-35**
  - 130 x 40 mm **AK-2330-40**
- 
- 155 x 40 mm **AK-2330-40**

**BREISKY**

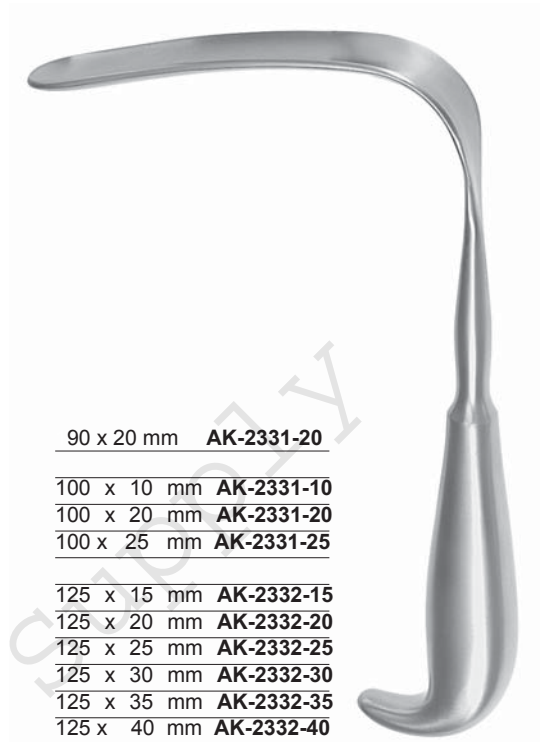

- 90 x 20 mm **AK-2331-20**
- 
- 100 x 10 mm **AK-2331-10**
  - 100 x 20 mm **AK-2331-20**
  - 100 x 25 mm **AK-2331-25**
- 
- 125 x 15 mm **AK-2332-15**
  - 125 x 20 mm **AK-2332-20**
  - 125 x 25 mm **AK-2332-25**
  - 125 x 30 mm **AK-2332-30**
  - 125 x 35 mm **AK-2332-35**
  - 125 x 40 mm **AK-2332-40**

**MATZENAUER**



85 x 17 mm

**BRAUN, MODIF.**  
 19,0 cm, 7 1/2"  
**AK-2333-19**



60 x 30 mm

**DOYEN**  
 23,0 cm, 9"  
**AK-2333-23**

80 x 30 mm

**DOYEN**  
 25,0 cm, 9"  
**AK-2333-25**



95 x 38 mm

**WERTHEIM**  
 30,0 cm, 12"  
**AK-2333-30**

Endospekula, Lateral-Spekulum, Intrauterinsonde  
 Endospecula, Lateral Speculum, Intrauterine Probe  
 Endoespéculos, Espéculo lateral, Sonda intra-uterina  
 Endospeculi, Speculo lateral, Sonde intrauterine

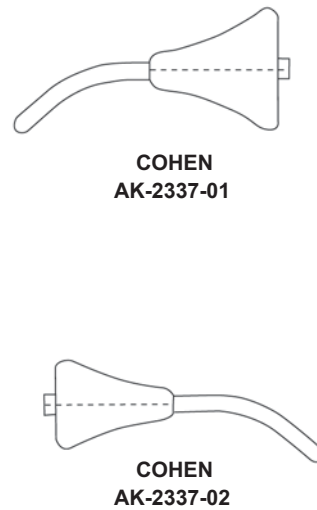
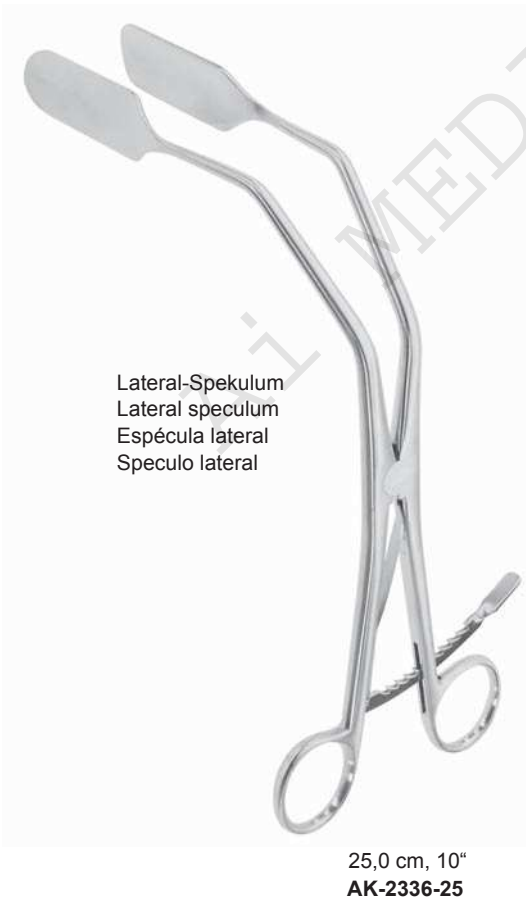

**Uterus-Dilatatoren**  
**Uterine Dilators**  
**Dilatadores uterinos**  
**Dilatatori uterini**



**HEGAR**  
 18,5 cm, 7¼"

Ø 1,0 mm	<b>AK-2338-01</b>
Ø 2,0 mm	<b>AK-2338-02</b>
Ø 3,0 mm	<b>AK-2338-03</b>
Ø 4,0 mm	<b>AK-2338-04</b>
Ø 5,0 mm	<b>AK-2338-05</b>
Ø 6,0 mm	<b>AK-2338-06</b>
Ø 7,0 mm	<b>AK-2338-07</b>
Ø 8,0 mm	<b>AK-2338-08</b>
Ø 9,0 mm	<b>AK-2338-09</b>
Ø 10,0 mm	<b>AK-2338-10</b>
Ø 11,0 mm	<b>AK-2338-11</b>
Ø 12,0 mm	<b>AK-2338-12</b>
Ø 13,0 mm	<b>AK-2338-13</b>
Ø 14,0 mm	<b>AK-2338-14</b>
Ø 15,0 mm	<b>AK-2338-15</b>
Ø 16,0 mm	<b>AK-2338-16</b>
Ø 17,0 mm	<b>AK-2338-17</b>
Ø 18,0 mm	<b>AK-2338-18</b>
Ø 19,0 mm	<b>AK-2338-19</b>
Ø 20,0 mm	<b>AK-2338-20</b>
Ø 21,0 mm	<b>AK-2338-21</b>
Ø 22,0 mm	<b>AK-2338-22</b>
Ø 23,0 mm	<b>AK-2338-23</b>
Ø 24,0 mm	<b>AK-2338-24</b>
Ø 25,0 mm	<b>AK-2338-25</b>
Ø 26,0 mm	<b>AK-2338-26</b>



**HEGAR**  
 18,5 cm, 7¼"

Ø 1,5 mm	<b>AK-2339-01</b>
Ø 2,5 mm	<b>AK-2339-02</b>
Ø 3,5 mm	<b>AK-2339-03</b>
Ø 4,5 mm	<b>AK-2339-04</b>
Ø 5,5 mm	<b>AK-2339-05</b>
Ø 6,5 mm	<b>AK-2339-06</b>
Ø 7,5 mm	<b>AK-2339-07</b>
Ø 8,5 mm	<b>AK-2339-08</b>
Ø 9,5 mm	<b>AK-2339-09</b>
Ø 10,5 mm	<b>AK-2339-10</b>
Ø 11,5 mm	<b>AK-2339-11</b>
Ø 12,5 mm	<b>AK-2339-12</b>
Ø 13,5 mm	<b>AK-2339-13</b>
Ø 14,5 mm	<b>AK-2339-14</b>
Ø 15,5 mm	<b>AK-2339-15</b>
Ø 16,5 mm	<b>AK-2339-16</b>
Ø 17,5 mm	<b>AK-2339-17</b>



205 x 105 x 45 mm

**HEGAR**  
**AK-2340-99**  
 Satz, Set, Juego, Set  
 Ø 1,0 - Ø 26,0  
 (26 dilators)

**HEGAR**  
**AK-2340-98**  
 Satz, Set, Juego, Set  
 Ø 4,0 - Ø 17,0  
 (14 dilators)



**HEGAR**  
 20,0 cm, 8"

1,0 / 2,0 mm	<b>AK-2341-01</b>
Ø 3,0 / 4,0 mm	<b>AK-2341-03</b>
Ø 5,0 / 6,0 mm	<b>AK-2341-05</b>
Ø 7,0 / 8,0 mm	<b>AK-2341-07</b>
Ø 9,0 / 10,0 mm	<b>AK-2341-09</b>
Ø 11,0 / 12,0 mm	<b>AK-2341-11</b>
Ø 13,0 / 14,0 mm	<b>AK-2341-13</b>
Ø 15,0 / 16,0 mm	<b>AK-2341-15</b>
Ø 17,0 / 18,0 mm	<b>AK-2341-17</b>
Ø 19,0 / 20,0 mm	<b>AK-2341-19</b>
Ø 21,0 / 22,0 mm	<b>AK-2341-21</b>
Ø 23,0 / 24,0 mm	<b>AK-2341-23</b>
Ø 25,0 / 26,0 mm	<b>AK-2341-25</b>



**HEGAR**  
**AK-2342-98**  
 Satz, Set, Juego, Set  
 Ø 3,0 / 4,0 - Ø 17,0 / 18,0 mm  
 (8 dilators)

**HEGAR**  
**AK-2343-99**  
 Satz, Set, Juego, Set  
 Ø 1,0 / 2,0 - Ø 25,0 / 26,0 mm  
 (13 dilators)



**HANK**

Ø 4,5 / 5,0 mm	<b>AK-2344-05</b>
Ø 5,5 / 6,0 mm	<b>AK-2344-06</b>
Ø 6,5 / 7,0 mm	<b>AK-2344-07</b>
Ø 7,5 / 8,0 mm	<b>AK-2344-08</b>
Ø 8,5 / 9,0 mm	<b>AK-2344-09</b>
Ø 9,5 / 10,0 mm	<b>AK-2344-10</b>

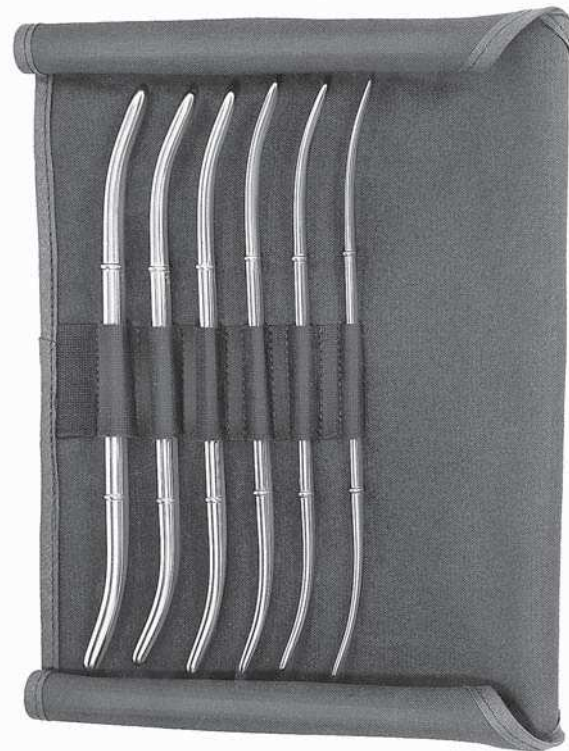

**HANK**  
**AK-2345-98**  
 Satz, Set, Juego, Set  
 Ø 4,5 / 5,0 - Ø 9,5 / 10,0 mm  
 (6 dilators)

**Uterus-Dilatatoren, Hakenzangen**  
**Uterine Dilators, Uterine Tenaculum Forceps**  
**Dilatadores uterinos, Pinzas para coger el cuello del útero**  
**Dilatatori uterini, Pinze per abbassare il collo del'utero**



Ø 4,5 / 5,0 mm	<b>AK-2346-05</b>
Ø 5,5 / 6,0 mm	<b>AK-2346-06</b>
Ø 7,5 / 8,0 mm	<b>AK-2346-08</b>
Ø 8,5 / 9,0 mm	<b>AK-2346-09</b>
Ø 9,5 / 10,0 mm	<b>AK-2346-10</b>
Ø 11,5 / 12,0 mm	<b>AK-2346-12</b>
Ø 12,5 / 13,0 mm	<b>AK-2346-13</b>
Ø 13,5 / 14,0 mm	<b>AK-2346-14</b>

**PRATT**



**PRATT**  
**AK-2347-98**

Satz, Set, Juego, Set  
 Ø 4,5 / 5,0 - Ø 13,5 / 14,0 mm  
 (8 dilators)



**BARRETT**  
 18,0 cm, 7"  
**AK-2348-18**



**ADAIR**  
 19,0 cm, 7½"  
**AK-2349-19**



**STAUDE-MOORE**  
 17,0 cm, 6¾"  
**AK-2350-17**



Hakenzangen  
Uterine Tenaculum Forceps  
Pinzas para coger el cuello del útero  
Pinze per abbassare il collo dell'utero

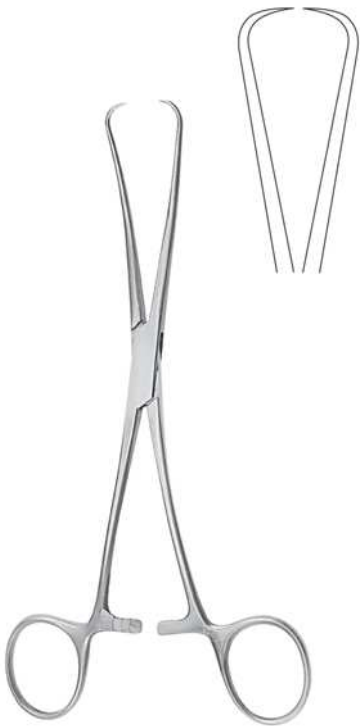

**JARCHO**  
20,0 cm, 8"  
AK-2351-20



**SCHROEDER**  
25,0 cm, 9<sup>3</sup>/<sub>4</sub>"  
AK-2352-25



**BRAUN**  
25,0 cm, 9<sup>3</sup>/<sub>4</sub>"  
AK-2353-25



**DUPLAY**  
28,0 cm, 11"  
AK-2354-28



**POZZI**  
26,0 cm, 10<sup>1</sup>/<sub>4</sub>"  
AK-2355-26



**KAHN**  
24,0 cm, 9<sup>1</sup>/<sub>2</sub>"  
AK-2356-24

**Hakenzangen**  
**Uterine Tenaculum Forceps**  
**Pinzas para coger el cuello del útero**  
**Pinze per abbassare il collo dell'utero**



**SKENE**  
 24,0 cm, 9 1/2"  
 AK-2357-24



**SCHROEDER**  
 24,0 cm, 9 1/2"  
 AK-2358-24



**SCHROEDER**  
 24,0 cm, 9 1/2"  
 AK-2359-24



**TEALE**  
 23,0 cm, 9"  
 AK-2360-23



**JACOBS**  
 21,0 cm, 8 1/2"  
 AK-2361-21



**JACOBS**  
 21,0 cm, 8 1/2"  
 AK-2362-21

**Hakenzangen**  
**Uterine Tenaculum Forceps**  
**Pinzas para coger el cuello del útero**  
**Pinze per abbassare il collo dell'utero**

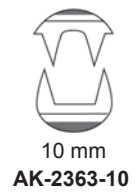
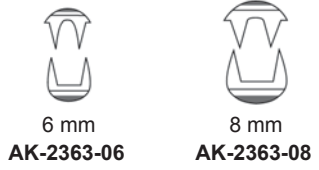

**MUSEUX**  
24,0 cm, 9½"

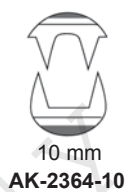

**MUSEUX**  
24,0 cm, 9½"



**BRAUN**  
15,5 cm, 6"  
AK-2365-15



**CZERNY**  
20,5 cm, 8"  
AK-2366-20



**PRATT**  
28,0 cm, 11"  
AK-2367-28

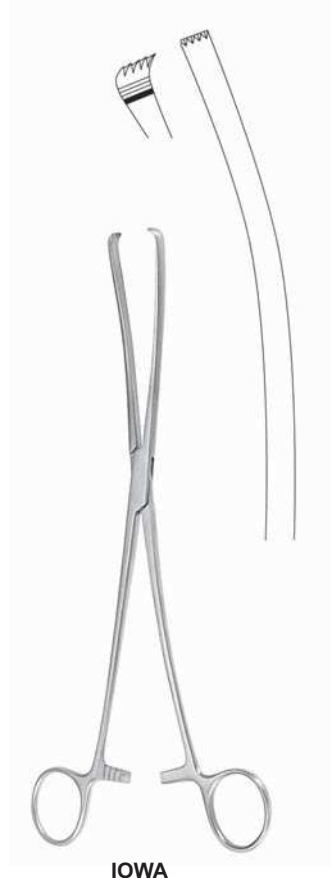

**IOWA**  
26,0 cm, 10¼"  
AK-2368-26

Polypen- und Ovarienzangen, Uterusfaßzangen  
 Polypus and Ovum Forceps, Uterine Elevating Forceps  
 Pinzas para pólipos uterinos y ovarios, Pinzas para la útero  
 Pinze per polipi e ovaie, Pinze per affarrare l'utero



**DOYEN**  
 20,5 cm, 8"  
 AK-2369-20



**NOTO**  
 27,0 cm, 10<sup>5</sup>/<sub>8</sub>"  
 AK-2370-27

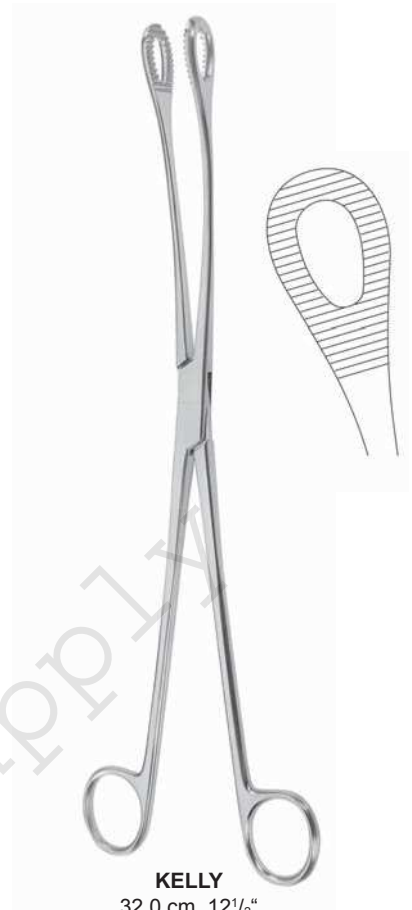

**KELLY**  
 32,0 cm, 12<sup>1</sup>/<sub>2</sub>"  
 AK-2371-32



**HEYWOOD-SMITH**  
 25,0 cm, 9<sup>3</sup>/<sub>4</sub>"  
 AK-2372-25



**DARTIGUES**  
 27,0 cm, 10<sup>3</sup>/<sub>4</sub>"  
 AK-2373-27



**SOMER**  
 23,0 cm, 9"  
 AK-2374-23

Uterusfaßzangen, Uterussonden, Zentimereinteilung  
 Uterine Elevating Forceps, Uterine Probes, graduated in centimeters  
 Pinzas para la útero, Histerómetros, graduado en centímetros  
 Pinze per affarrare l'utero, Isterometri, graduato in cm



**COLLIN**  
 25,0 cm, 9<sup>3</sup>/<sub>4</sub>"  
 AK-2375-25



**BEACHAM**  
 26,0 cm, 10<sup>1</sup>/<sub>4</sub>"  
 AK-2376-26

Amniotom  
 Amniotome  
 Amniótomo  
 Amniotomo



**BRAUN**  
 28,0 cm, 11"  
 AK-2377-28

Uterus-Depressor  
 Uterine depressor  
 Depresor uterino  
 Depressori uterini



**SIMS**  
 32,0 cm, 12<sup>1</sup>/<sub>2</sub>"  
 AK-2378-32



**SIMS**  
 32,0 cm, 12<sup>1</sup>/<sub>2</sub>"  
 AK-2379-32

biegsam  
 malleable  
 maleable  
 malleabile



**MARTIN**  
 32,0 cm, 12<sup>1</sup>/<sub>2</sub>"  
 AK-2380-32



**MARTIN**  
 32,0 cm, 12<sup>1</sup>/<sub>2</sub>"  
 AK-2381-32

biegsam  
 malleable  
 maleable  
 malleabile



**VALLEIX**  
 25,0 cm, 10"  
 AK-2382-25

Ø 4 mm



**SIMPSON**  
 29,0 cm, 11<sup>1</sup>/<sub>2</sub>"  
 AK-2383-29

biegsam  
 malleable  
 maleable  
 malleabile

Ø 4 mm



**COLLIN**  
 28,0 cm, 11"  
 AK-2384-28

**Biopsieküretten**  
**Biopsy Curettes**  
**Curetas para biopsia**  
**Curette per biopsia**



**KEVORKIAN**  
 30,0 cm, 12"  
**AK-2385-30**



**KEVORKIAN**  
 30,0 cm, 12"  
**AK-2386-30**



**KEVORKIAN**  
 30,0 cm, 12"  
**AK-2387-30**

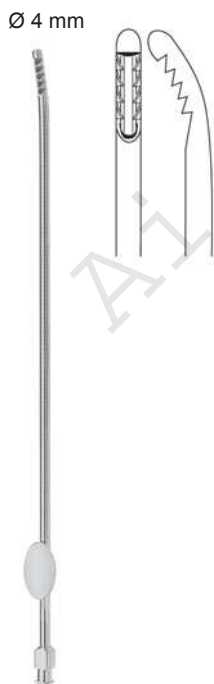

**NOVAK**  
 23,0 cm, 9"  
**AK-2391-04**

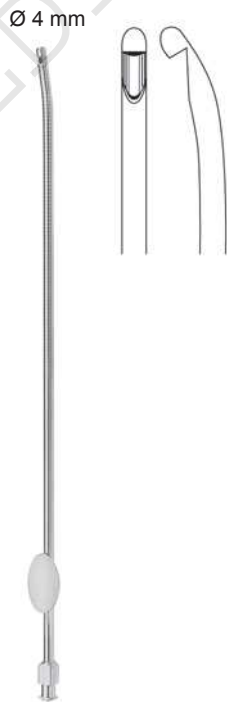

**RANDALL**  
 23,0 cm, 9"  
**AK-2392-04**



**MILAN**  
 29,0 cm, 11½"

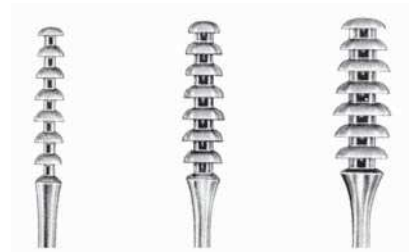

Ø 4 mm  
**AK-2388-04**

Ø 4 mm  
**AK-2389-04**

Ø 4 mm  
**AK-2390-04**

Myominstrumente  
Myoma Instruments  
Instrumentos para mioma  
Strumenti per fibroma



**UTERUSPERFORATOR**  
25,0 cm, 9<sup>3</sup>/<sub>4</sub>"  
AK-2393-25



**FISTELHAKEN**  
25,0 cm, 9<sup>3</sup>/<sub>4</sub>"  
AK-2394-25



**SIMON**  
22,0 cm, 8<sup>5</sup>/<sub>8</sub>"  
AK-2395-22



**EMMETT**  
22,0 cm, 8<sup>5</sup>/<sub>8</sub>"



AK-2396-01



AK-2396-02



AK-2396-03



AK-2396-04



AK-2396-05



**SEGOND**  
27,0 cm, 10<sup>5</sup>/<sub>8</sub>"  
AK-2397-27

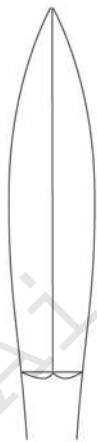

**AYRE**  
23,0 cm, 9"  
AK-2397-23



**DOYEN**  
19,0 cm, 7<sup>1</sup>/<sub>2</sub>"  
AK-2397-01



**DOYEN**  
17,0 cm, 6<sup>3</sup>/<sub>4</sub>"  
AK-2397-02

Uterusküretten  
 Uterine Curettes  
 Curetas uterinas  
 Curette uterine



scharf, fest  
 sharp, rigid  
 cortantes, rígidas  
 acute, rigide

- Fig. 00 **AK-2398-05**
- Fig. 0 **AK-2398-06**
- Fig. 1 **AK-2398-07**
- Fig. 2 **AK-2398-08**
- Fig. 3 **AK-2398-09**
- Fig. 4 **AK-2398-11**
- Fig. 5 **AK-2398-12**
- Fig. 6 **AK-2398-14**
- Fig. 7 **AK-2398-15**
- Fig. 8 **AK-2398-16**
- Fig. 9 **AK-2398-19**
- Fig. 10 **AK-2398-20**
- Fig. 11 **AK-2398-21**
- Fig. 12 **AK-2398-23**

**RECAMIER**  
 26,0 cm, 10 1/4"



scharf, biegsam  
 sharp, malleable  
 cortantes, maleable  
 acute, malleabile

- Fig. 00 **AK-2399-05**
- Fig. 0 **AK-2399-06**
- Fig. 1 **AK-2399-07**
- Fig. 2 **AK-2399-08**
- Fig. 3 **AK-2399-09**
- Fig. 4 **AK-2399-11**
- Fig. 5 **AK-2399-12**
- Fig. 6 **AK-2399-14**
- Fig. 7 **AK-2399-15**
- Fig. 8 **AK-2399-16**
- Fig. 9 **AK-2399-19**
- Fig. 10 **AK-2399-20**
- Fig. 11 **AK-2399-21**
- Fig. 12 **AK-2399-23**

**RECAMIER**  
 26,0 cm, 10 1/4"



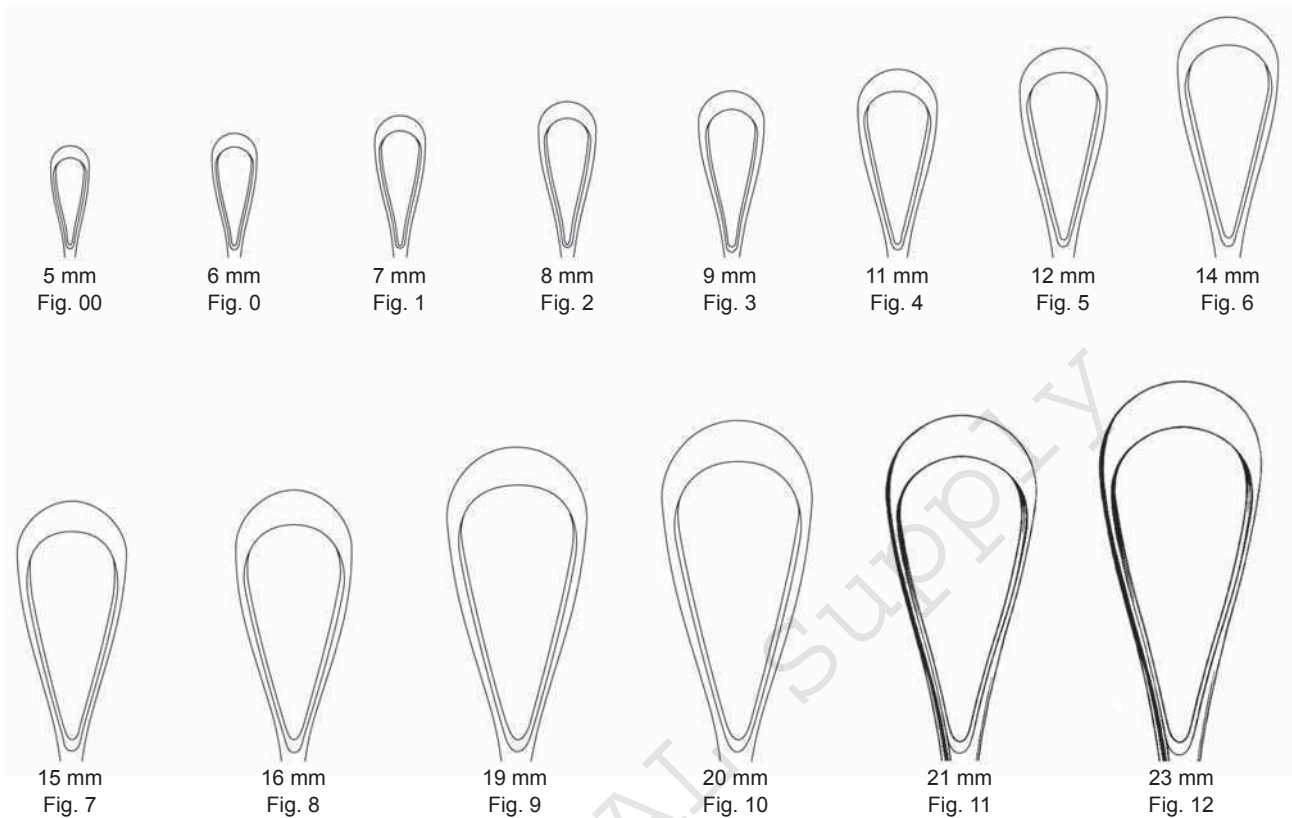

scharf, fest  
 sharp, rigid  
 cortantes, rígidas  
 acute, rigide

Fig. 00	AK-2400-05
Fig. 0	AK-2400-06
Fig. 1	AK-2400-07
Fig. 2	AK-2400-08
Fig. 3	AK-2400-09
Fig. 4	AK-2400-11
Fig. 5	AK-2400-12
Fig. 6	AK-2400-14
Fig. 7	AK-2400-15
Fig. 8	AK-2400-16
Fig. 9	AK-2400-19
Fig. 10	AK-2400-20
Fig. 11	AK-2400-21
Fig. 12	AK-2400-23

**SIMS**  
 26,0 cm, 10 1/4"



scharf, biegsam  
 sharp, malleable  
 cortantes, maleable  
 acute, malleabile

Fig. 00	AK-2401-05
Fig. 0	AK-2401-06
Fig. 1	AK-2401-07
Fig. 2	AK-2401-08
Fig. 3	AK-2401-09
Fig. 4	AK-2401-11
Fig. 5	AK-2401-12
Fig. 6	AK-2401-14
Fig. 7	AK-2401-15
Fig. 8	AK-2401-16
Fig. 9	AK-2401-19
Fig. 10	AK-2401-20
Fig. 11	AK-2401-21
Fig. 12	AK-2401-23

**SIMS**  
 26,0 cm, 10 1/4"

**Uterusküretten**  
**Uterine Curettes**  
**Curetas uterinas**  
**Curette uterine**

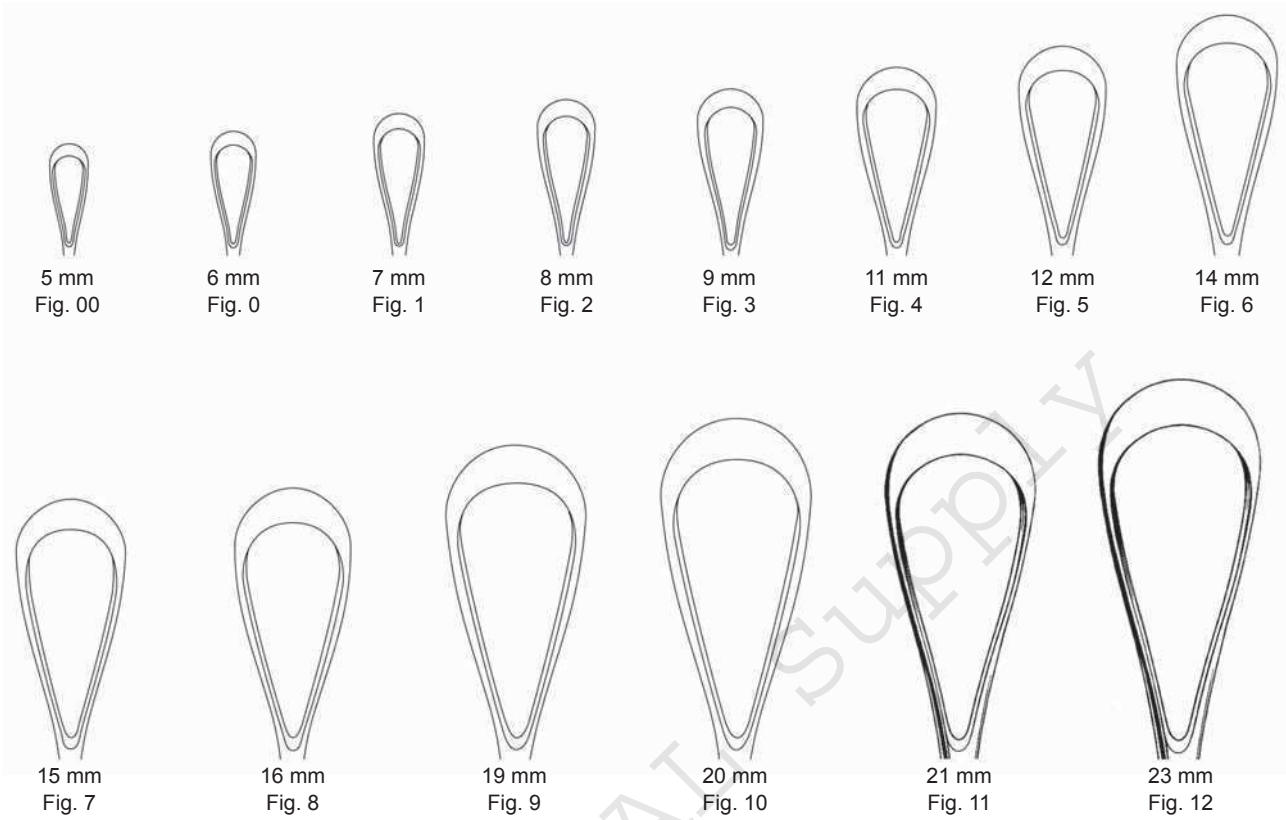

scharf, fest  
 sharp, rigid  
 cortantes, rígidas  
 acute, rigide

Fig. 00	<b>AK-2402-05</b>
Fig. 0	<b>AK-2402-06</b>
Fig. 1	<b>AK-2402-07</b>
Fig. 2	<b>AK-2402-08</b>
Fig. 3	<b>AK-2402-09</b>
Fig. 4	<b>AK-2402-11</b>
Fig. 5	<b>AK-2402-12</b>
Fig. 6	<b>AK-2402-14</b>
Fig. 7	<b>AK-2402-15</b>
Fig. 8	<b>AK-2402-16</b>
Fig. 9	<b>AK-2402-19</b>
Fig. 10	<b>AK-2402-20</b>
Fig. 11	<b>AK-2402-21</b>
Fig. 12	<b>AK-2402-23</b>

**RECAMIÉR**  
 31,0 cm, 12¼"



scharf, biegsam  
 sharp, malleable  
 cortantes, maleable  
 acute, malleabile

Fig. 00	<b>AK-2403-05</b>
Fig. 0	<b>AK-2403-06</b>
Fig. 1	<b>AK-2403-07</b>
Fig. 2	<b>AK-2403-08</b>
Fig. 3	<b>AK-2403-09</b>
Fig. 4	<b>AK-2403-11</b>
Fig. 5	<b>AK-2403-12</b>
Fig. 6	<b>AK-2403-14</b>
Fig. 7	<b>AK-2403-15</b>
Fig. 8	<b>AK-2403-16</b>
Fig. 9	<b>AK-2403-19</b>
Fig. 10	<b>AK-2403-20</b>
Fig. 11	<b>AK-2403-21</b>
Fig. 12	<b>AK-2403-23</b>

**RECAMIÉR**  
 31,0 cm, 12¼"



scharf, fest  
 sharp, rigid  
 cortantes, rígidas  
 acute, rigide

Fig. 00	AK-2404-05
Fig. 0	AK-2404-06
Fig. 1	AK-2404-07
Fig. 2	AK-2404-08
Fig. 3	AK-2404-09
Fig. 4	AK-2404-11
Fig. 5	AK-2404-12
Fig. 6	AK-2404-14
Fig. 7	AK-2404-15
Fig. 8	AK-2404-16
Fig. 9	AK-2404-19
Fig. 10	AK-2404-20
Fig. 11	AK-2404-21
Fig. 12	AK-2404-23

**SIMS**  
 31,0 cm, 12<sup>1</sup>/<sub>4</sub>"



scharf, biegsam  
 sharp, malleable  
 cortantes, maleable  
 acute, malleabile

Fig. 00	AK-2405-05
Fig. 0	AK-2405-06
Fig. 1	AK-2405-07
Fig. 2	AK-2405-08
Fig. 3	AK-2405-09
Fig. 4	AK-2405-11
Fig. 5	AK-2405-12
Fig. 6	AK-2405-14
Fig. 7	AK-2405-15
Fig. 8	AK-2405-16
Fig. 9	AK-2405-19
Fig. 10	AK-2405-20
Fig. 11	AK-2405-21
Fig. 12	AK-2405-23

**SIMS**  
 31,0 cm, 12<sup>1</sup>/<sub>4</sub>"

**Uterusküretten**  
**Uterine Curettes**  
**Curetas uterinas**  
**Curette uterine**

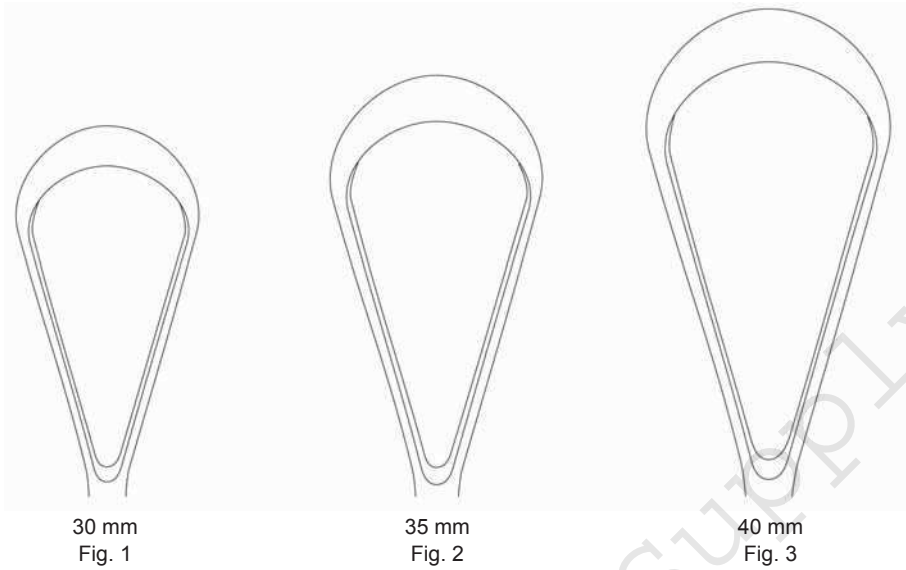

30 mm  
Fig. 1

35 mm  
Fig. 2

40 mm  
Fig. 3



scharf, fest  
 sharp, rigid  
 cortantes, rígidas  
 acute, rigide

Fig. 1 **AK-2406-30**  
 Fig. 2 **AK-2406-35**  
 Fig. 3 **AK-2406-40**

**SIMS**  
 31,0 cm, 12<sup>1</sup>/<sub>4</sub>"



scharf, biegsam  
 sharp, malleable  
 cortantes, maleable  
 acute, malleabile

Fig. 1 **AK-2407-30**  
 Fig. 2 **AK-2407-35**  
 Fig. 3 **AK-2407-40**

**SIMS**  
 31,0 cm, 12<sup>1</sup>/<sub>4</sub>"

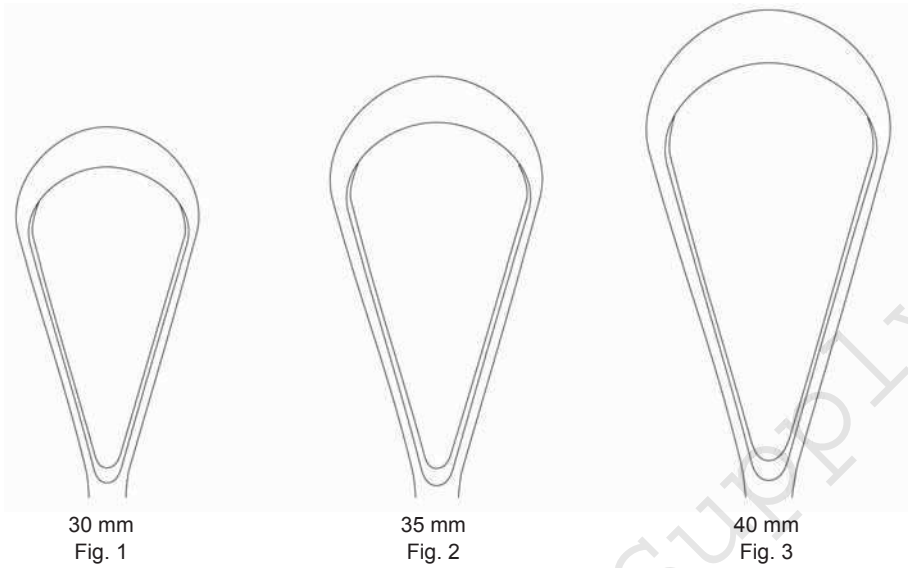

30 mm  
 Fig. 1

35 mm  
 Fig. 2

40 mm  
 Fig. 3



scharf, fest  
 sharp, rigid  
 cortantes, rígidas  
 acute, rigide

Fig. 1 **AK-2408-30**  
 Fig. 2 **AK-2408-35**  
 Fig. 3 **AK-2408-40**

**BUMM**  
 31,0 cm, 12<sup>1</sup>/<sub>4</sub>"



scharf, biegsam  
 sharp, malleable  
 cortantes, maleable  
 acute, malleabile

Fig. 1 **AK-2409-30**  
 Fig. 2 **AK-2409-35**  
 Fig. 3 **AK-2409-40**

**BUMM**  
 31,0 cm, 12<sup>1</sup>/<sub>4</sub>"

**Uteruslöffel, Uterus-Biopsiezangen**  
**Uterine Scoopes, Cervical Biopsy and Specimen Forceps**  
**Cucharillas uterinas, Pinzas saca-bocados para biopsia**  
**Curette uterine, Pinze per la biopsia cervicale e da prelievo**



**BLAKE**  
 27,0 cm, 10<sup>5</sup>/<sub>8</sub>"  
**AK-2411-27**



**SIMON**  
 25,0 cm, 9<sup>3</sup>/<sub>4</sub>"

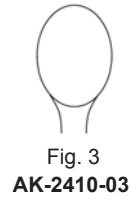
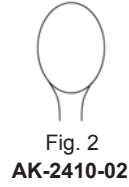
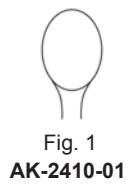

**THOMS-GAYLOR**  
 22,0 cm, 8<sup>5</sup>/<sub>8</sub>" **AK-2412-22**  
 24,0 cm, 9<sup>1</sup>/<sub>2</sub>" **AK-2412-24**



**SCHUBERT**  
 21,0 cm, 8<sup>1</sup>/<sub>4</sub>" **AK-2413-21**  
 29,0 cm, 11<sup>1</sup>/<sub>2</sub>" **AK-2413-29**



**SCHUMACHER-VAN DOREN**  
 24,0 cm, 9<sup>1</sup>/<sub>2</sub>"  
**AK-2414-24**



**Uterus-Biopsiezangen**  
**Cervical Biopsy and Specimen Forceps**  
**Pinzas saca-bocados para biopsia**  
**Pinze per la biopsia cervicale e da prelievo**



**THOMS-GAYLOR**  
 24,0 cm, 9 1/2"  
 AK-2415-24



**FAURE**  
 21,0 cm, 8 1/4"  
 AK-2416-21



**SCHUBERT**  
 26,0 cm, 10 1/4"  
 AK-2417-26



9 x 3 mm

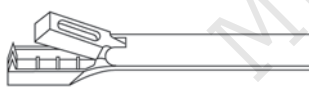

**KEVORKIAN**  
 25,0 cm, 10"  
 AK-2418-25

4,5 x 8 mm

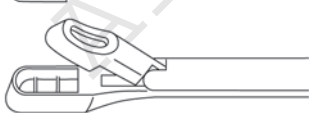

**EPPENDORFER**  
 20,0 cm, 8"  
 AK-2419-20

6,0 mm



**SCHUMACHER**  
 24,0 cm, 9 1/2"  
 AK-2422-06

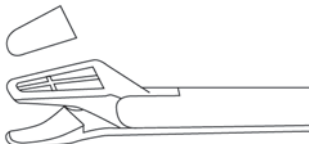

**ALEXANDER**  
 28,0 cm, 11"  
 AK-2420-28

4,5 x 8 mm



**WITTNER**  
 23,0 cm, 9"  
 AK-2423-23

4,0 mm

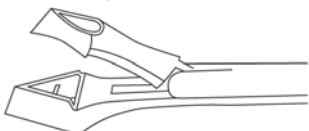

**SCHUMACHER**  
 24,0 cm, 9 1/2"  
 AK-2421-04

4,5 x 8 mm



**WITTNER**  
 23,0 cm, 9"  
 AK-2424-23

Uterus-Biopsiezangen  
 Cervical Biopsy and Specimen Forceps  
 Pinzas saca-bocados para biopsia  
 Pinze per la biopsia cervicale e da prelievo

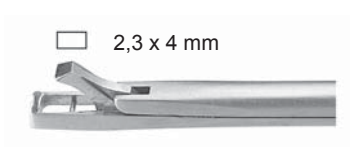
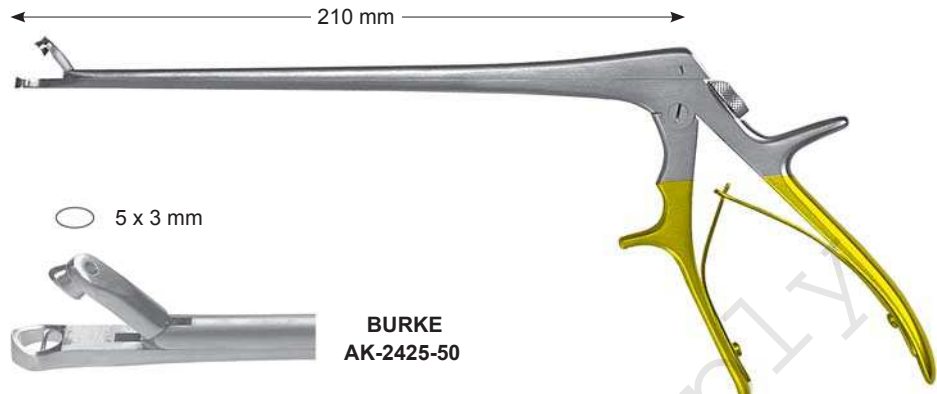



Geburtszangen  
Obstetrical Forceps  
Fórceps para obstétrica  
Forbici per ostetricia



**WRIGLEY**  
28,0 cm, 11"  
AK-2431-28



**SIMPSON**  
30,0 cm, 11<sup>3</sup>/<sub>4</sub>"  
AK-2432-30



**SIMPSON-BRAUN**  
33,0 cm, 13"  
AK-2433-33



**SIMPSON-BRAUN**  
36,0 cm, 14<sup>1</sup>/<sub>8</sub>"  
AK-2434-36



**SIMPSON-LUIKART**  
36,0 cm, 14<sup>1</sup>/<sub>8</sub>"  
AK-2435-36



**DE LEE**  
30,0 cm, 11<sup>3</sup>/<sub>4</sub>"  
AK-2436-30



**DE LEE**  
36,0 cm, 14<sup>1</sup>/<sub>8</sub>"  
AK-2437-36



**DE LEE**  
38,0 cm, 15<sup>3</sup>/<sub>8</sub>"  
AK-2438-38

Geburtszangen  
 Obstetrical Forceps  
 Fórceps para obstétrica  
 Forbici per ostetricia



**MC LEAN**  
 36,0 cm, 14<sup>1</sup>/<sub>8</sub>"  
 AK-2439-36



**KIELAND**  
 41,0 cm, 16"  
 AK-2440-41



**KIELAND-LUIKART**  
 40,0 cm, 15<sup>3</sup>/<sub>4</sub>"  
 AK-2441-40



**PIPER**  
 44,0 cm, 17<sup>1</sup>/<sub>4</sub>"  
 AK-2442-44



**ELLIOT**  
 32,0 cm, 12<sup>1</sup>/<sub>2</sub>"  
 AK-2443-32



**ELLIOT**  
 38,0 cm, 15"  
 AK-2444-38



**NAEGELE**  
 36,0 cm, 14<sup>1</sup>/<sub>8</sub>"  
 AK-2445-36



**NAEGELE**  
 40,0 cm, 15<sup>3</sup>/<sub>4</sub>"  
 AK-2446-40

Geburtszangen, Plazentar- und Abortuszangen  
 Obstetrical Forceps, Placenta and Ovum Forceps  
 Fórceps para obstétrica, Pinzas para aborto y placenta  
 Forbici per ostetricia, Pinze per placenta e per ovaie



**GREEN-ARMYTAGE**  
 21,0 cm, 8<sup>1</sup>/<sub>4</sub>"  
 AK-2447-21



**PESTALOZZA**  
 30,0 cm, 11<sup>3</sup>/<sub>4</sub>"  
 AK-2448-30



**SAENGER**  
 27,0 cm, 10<sup>5</sup>/<sub>8</sub>"  
 AK-2449-27



**SAENGER**  
 27,0 cm, 10<sup>5</sup>/<sub>8</sub>"  
 AK-2450-27



**WINTER**  
 28,0 cm, 11"



Fig. 1  
 AK-2451-01



Fig. 2  
 AK-2451-02

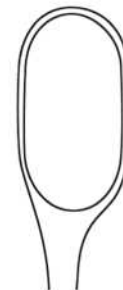

Fig. 3  
 AK-2451-03



Fig. 1  
 AK-2452-01

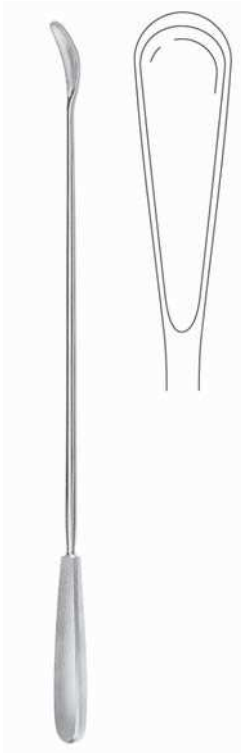

Fig. 2  
 AK-2452-02



Fig. 3  
 AK-2452-03

Plazentar- und Abortuszangen  
 Placenta and Ovum Forceps  
 Pinzas para aborto y placenta  
 Pinze per placenta e per ovaie



**WALLICH**  
 42,0 cm, 16½"  
 AK-2453-42



**MARTIN**  
 34,0 cm, 13¾"  
 AK-2454-34



**BIERER**  
 33,0 cm, 13"  
 AK-2455-01



**BIERER**  
 33,0 cm, 13"  
 AK-2456-02



**BIERER**  
 33,0 cm, 13"  
 AK-2457-01



**BIERER**  
 33,0 cm, 13"  
 AK-2458-02

**Vorbereitung, Dermatologie**  
**Preparation, Dermatology**  
**Preparación, Dermatología**  
**Preparazione, Dermatologia**



Hautstanzen, Nagel Instrumente  
 Dermal Punches, Nail Instruments  
 Trépanos cutáneos, Instrumentos para uñas  
 Trapani dermatici, Strumenti per unghie



**PIFFARD**  
 14,0 cm, 5<sup>3</sup>/<sub>4</sub>"

Lupusküretten  
 Lupus curettes  
 Curetas para lupus  
 Raschiatoio per lupus

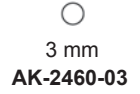

**KEYES**  
 12,0 cm, 4<sup>3</sup>/<sub>4</sub>"



**KEYES**  
 12,0 cm, 4<sup>3</sup>/<sub>4</sub>"  
**AK-2461-00**

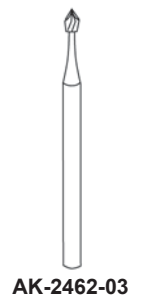
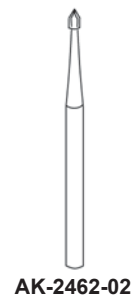
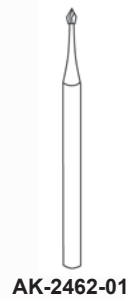

**NAGELBOHRER**  
**AK-2462-00**  
 komplett, complete,  
 completo, completo

Komedonenquetscher  
Comedo Extractors  
Saca-comedones  
Tiracomedoni



**UNNA**  
14,0 cm, 5<sup>3</sup>/<sub>4</sub>"  
AK-2463-14



**UNNA**  
14,0 cm, 5<sup>3</sup>/<sub>4</sub>"  
AK-2464-14



**SAALFELD**  
10,0 cm, 4"  
AK-2465-10



**SAALFELD**  
14,0 cm, 5<sup>3</sup>/<sub>4</sub>"  
AK-2466-14



**SCHAMBERG**  
10,0 cm, 4"  
AK-2467-10



**WALTON**  
14,0 cm, 5<sup>3</sup>/<sub>4</sub>"  
AK-2468-14



**FOX**  
14,0 cm, 5<sup>3</sup>/<sub>4</sub>"



Lupusküretten  
Lupus curettes  
Curetas para lupus  
Raschiatoio per lupus

**Nagel Instrumente**  
**Nail Instruments**  
**Instrumentos para uñas**  
**Strumenti per unghie**



059-1420-01

**FINGERRINGSÄGE**  
 17,0 cm, 6<sup>3</sup>/<sub>4</sub>"  
 AK-2470-17



059-1430-01

**WALTON**  
 16,0 cm, 6<sup>1</sup>/<sub>4</sub>"  
 AK-2471-16



**RADOLF**  
 13,5 cm, 5<sup>3</sup>/<sub>8</sub>"  
 AK-2472-13



**NAGELZANGE**  
 13,5 cm, 5<sup>3</sup>/<sub>8</sub>"  
 AK-2473-13



**NAGELZANGE**  
 13,0 cm, 5"  
 AK-2474-13



**NAGELZANGE**  
 14,0 cm, 5<sup>1</sup>/<sub>2</sub>"

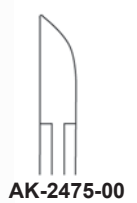

AK-2475-00

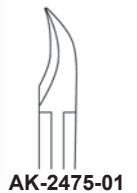

AK-2475-01



**Knochenchirurgie**  
**Bone Surgery**  
**Cirurgía ósea**  
**Chirurgia ossea**



Scharfe Löffel  
 Bone Curettes  
 Cucharillas cortantes  
 Curetta per ossa



**SCHIEDER**  
 17,0 cm, 6<sup>3</sup>/<sub>4</sub>"

- Fig. 000  
AK-2476-03
- Fig. 00  
AK-2476-02
- Fig. 0  
AK-2476-01
- Fig. 1  
AK-2476-11
- Fig. 2  
AK-2476-12
- Fig. 3  
AK-2476
- Fig. 4  
AK-2476



**VOLKMANN**  
 17,0 cm, 6<sup>3</sup>/<sub>4</sub>"

- Fig. 0000  
AK-2477-04
- Fig. 000  
AK-2477-03
- Fig. 00  
AK-2477-02
- Fig. 0  
AK-2477-01
- Fig. 1  
AK-2477-11
- Fig. 2  
AK-2477-12
- Fig. 3  
AK-2477-13
- Fig. 4  
AK-2477-14
- Fig. 5  
AK-2477-15
- Fig. 6  
AK-2477-16



**BRUNS**  
 17,0 cm, 6<sup>3</sup>/<sub>4</sub>"

- Fig. 0000  
AK-2478-04
- Fig. 000  
AK-2478-03
- Fig. 00  
AK-2478-02
- Fig. 0  
AK-2478-01
- Fig. 1  
AK-2478-11
- Fig. 2  
AK-2478-12
- Fig. 3  
AK-2478-13
- Fig. 4  
AK-2478-14
- Fig. 5  
AK-2478-15
- Fig. 6  
AK-2478-16



**LEMPERT**  
 21,5 cm, 8½"

Fig. 00000  
**AK-2479-04**

Fig. 0000  
**AK-2479-03**

Fig. 000  
**AK-2479-02**

Fig. 00  
**AK-2479-01**

Fig. 0  
**AK-2479-00**



**HALLE**  
 21,0 cm, 8¼"

Fig. 00  
**AK-2480-02**

Fig. 0  
**AK-2480-01**

Fig. 1  
**AK-2480-11**



**DAUBENSPECK**  
 20,0 cm, 8"

Fig. 00  
**AK-2481-02**

Fig. 0  
**AK-2481-01**

Fig. 1  
**AK-2481-11**

Fig. 2  
**AK-2481-12**

Scharfe Löffel  
 Bone Curettes  
 Cucharillas cortantes  
 Curetta per ossa



**WILLIGER**  
 17,0 cm, 6<sup>3</sup>/<sub>4</sub>"



Fig. 1  
**AK-2482-11**



Fig. 2  
**AK-2482-12**



**WILLIGER**  
 14,0 cm, 5<sup>1</sup>/<sub>2</sub>"



Fig. 0  
**AK-2483-00**



Fig. 1  
**AK-2483-01**



Fig. 2  
**AK-2483-02**



**MARTINI**  
 14,0 cm, 5<sup>1</sup>/<sub>2</sub>"  
**AK-2485-00**



Fig. 00/0  
**AK-2485-00**  
 14,0 cm, 5<sup>1</sup>/<sub>2</sub>"



Fig. 0/1  
**AK-2485-01**  
 14,0 cm, 5<sup>1</sup>/<sub>2</sub>"



Fig. 1/2  
**AK-2485-12**  
 14,0 cm, 5<sup>1</sup>/<sub>2</sub>"



**VOLKMANN**



**AK-2486-13**  
 13,0 cm, 5"



**AK-2486-14**  
 14,0 cm, 5<sup>1</sup>/<sub>2</sub>"



**AK-2486-17**  
 17,0 cm, 6<sup>3</sup>/<sub>4</sub>"



**JANSEN**  
 15,0 cm, 6"  
**AK-2487-15**



**JANSEN**  
 16,0 cm, 6<sup>1</sup>/<sub>4</sub>"  
**AK-2487-16**

Dissektoren, Elevatorien  
 Dissectors, Elevators  
 Disecadores, Elevadores  
 Dissettori, Elevatori

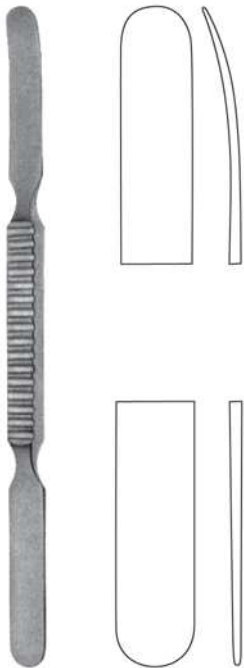

**WATSON-CHEYNE**  
 17,5 cm, 6<sup>5</sup>/<sub>8</sub>"  
 AK-2488-17



**MC DONALD**  
 19,0 cm, 7<sup>1</sup>/<sub>2</sub>"  
 AK-2488-19



**WILLIGER**  
 17,0 cm, 6<sup>3</sup>/<sub>4</sub>"  
 AK-2492-17



**WILLIGER**  
 16,0 cm, 6<sup>1</sup>/<sub>4</sub>"  
 AK-2489-16



**LANGENBECK**  
 20,0 cm, 8"  
 AK-2490-08



**LANGENBECK**  
 20,0 cm, 8"  
 AK-2491-10

Raspatorien  
 Raspatories  
 Periostótomos  
 Periostotomi



**ADSON**  
 17,0 cm, 6<sup>3</sup>/<sub>4</sub>"

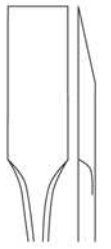

8 mm  
 AK-2493-01

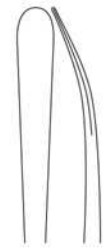

7 mm  
 AK-2493-02

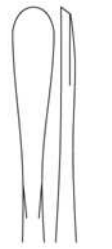

7 mm  
 AK-2493-03

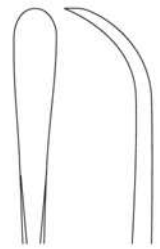

7 mm  
 AK-2493-04



**KÖNIG**  
 15,5 cm, 6"  
 AK-2494-15

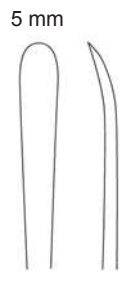

5 mm



**LAMBOTTE**  
 21,0 cm, 8<sup>1</sup>/<sub>4</sub>"



10 mm  
 AK-2494-10



15 mm  
 AK-2494-15



20 mm  
 AK-2494-20

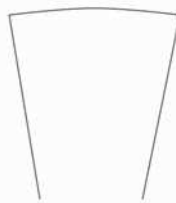

25 mm  
 AK-2494-25



**FARABEUF**  
 15,0 cm, 6"  
 AK-2495-15



12,5 mm

Raspatorien  
Raspatories  
Periostótomos  
Periostotomi

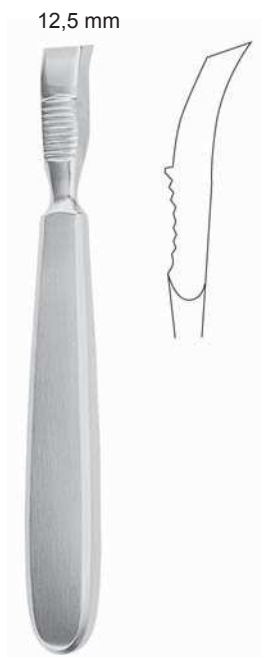

**FARABEUF**  
15,0 cm, 6"  
AK-2496-15



**LANGENBECK**  
19,0 cm, 7 1/2"  
AK-2497-19



**SEDILLOT**  
21,0 cm, 8 1/4"  
AK-2498-21



**WILLIGER**  
16,0 cm, 6 1/4"

4 mm	AK-2499-04
6 mm	AK-2499-06
8 mm	AK-2499-08



für Kinder  
for children  
para niños  
per bambini

**DOYEN**  
17,0 cm, 6 3/4"  
AK-2500-17



für Kinder  
for children  
para niños  
per bambini

**DOYEN**  
17,0 cm, 6 3/4"  
AK-2501-17



für Erwachsene  
for adults  
para adultos  
per adulti

**DOYEN**  
17,0 cm, 6 3/4"  
AK-2502-17



für Erwachsene  
for adults  
para adultos  
per adulti

**DOYEN**  
17,0 cm, 6 3/4"  
AK-2503-17

Flachmeißel, Hohlmeißel, Osteotome  
 Chisels, Gouges, Osteotomes  
 Cinceles, Gubias, Osteótomos  
 Scalpelli, Sgorbie, Osteotomi



8,0 mm	<b>AK-2504-08</b>
10,0 mm	<b>AK-2504-10</b>
12,0 mm	<b>AK-2504-12</b>
14,0 mm	<b>AK-2504-14</b>
16,0 mm	<b>AK-2504-16</b>

13,5 cm, 5<sup>3</sup>/<sub>8</sub>"



8,0 mm	<b>AK-2505-08</b>
10,0 mm	<b>AK-2505-10</b>
12,0 mm	<b>AK-2505-12</b>
14,0 mm	<b>AK-2505-14</b>
16,0 mm	<b>AK-2505-16</b>

13,5 cm, 5<sup>3</sup>/<sub>8</sub>"



8,0 mm	<b>AK-2506-08</b>
10,0 mm	<b>AK-2506-10</b>
12,0 mm	<b>AK-2506-12</b>
14,0 mm	<b>AK-2506-14</b>
16,0 mm	<b>AK-2506-16</b>

13,5 cm, 5<sup>3</sup>/<sub>8</sub>"



3,0 mm	<b>AK-2507-03</b>
4,0 mm	<b>AK-2507-04</b>
5,0 mm	<b>AK-2507-05</b>
6,0 mm	<b>AK-2507-06</b>

**PARTSCH**  
 13,5 cm, 5<sup>3</sup>/<sub>8</sub>"



3,0 mm	<b>AK-2508-03</b>
4,0 mm	<b>AK-2508-04</b>
5,0 mm	<b>AK-2508-05</b>
6,0 mm	<b>AK-2508-06</b>

**PARTSCH**  
 13,5 cm, 5<sup>3</sup>/<sub>8</sub>"



10,0 mm	<b>AK-2509-10</b>
15,0 mm	<b>AK-2509-15</b>
20,0 mm	<b>AK-2509-20</b>
25,0 mm	<b>AK-2509-25</b>

**STILLE**  
 20,0 cm, 8"



Flachmeißel, Hohlmeißel, Osteotome  
 Chisels, Gouges, Osteotomes  
 Cinceles, Gubias, Osteótomos  
 Scalpelli, Sgorbie, Osteotomi



10,0 mm	<b>AK-2510-10</b>
15,0 mm	<b>AK-2510-15</b>
20,0 mm	<b>AK-2510-20</b>
25,0 mm	<b>AK-2510-25</b>

**STILLE**  
 20,0 cm, 8"



10,0 mm	<b>AK-2511-10</b>
15,0 mm	<b>AK-2511-15</b>
20,0 mm	<b>AK-2511-20</b>
25,0 mm	<b>AK-2511-25</b>

**STILLE**  
 20,0 cm, 8"

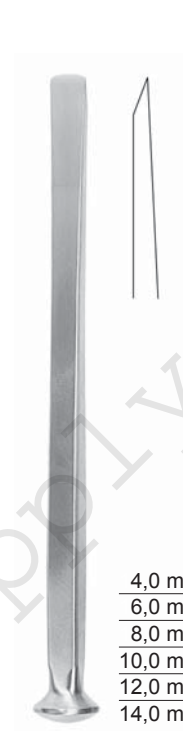

4,0 mm	<b>AK-2512-04</b>
6,0 mm	<b>AK-2512-06</b>
8,0 mm	<b>AK-2512-08</b>
10,0 mm	<b>AK-2512-10</b>
12,0 mm	<b>AK-2512-12</b>
14,0 mm	<b>AK-2512-14</b>

**ALEXANDER**  
 18,0 cm, 7"



4,0 mm	<b>AK-2513-04</b>
6,0 mm	<b>AK-2513-06</b>
8,0 mm	<b>AK-2513-08</b>
10,0 mm	<b>AK-2513-10</b>
12,0 mm	<b>AK-2513-12</b>
14,0 mm	<b>AK-2513-14</b>

**ALEXANDER**  
 18,0 cm, 7"



6,0 mm	<b>AK-2514-06</b>
9,0 mm	<b>AK-2514-09</b>
13,0 mm	<b>AK-2514-13</b>
16,0 mm	<b>AK-2514-16</b>
19,0 mm	<b>AK-2514-19</b>
25,0 mm	<b>AK-2514-25</b>
32,0 mm	<b>AK-2514-32</b>

**SMITH-PETERSEN**  
 20,0 cm, 8"



6,0 mm	<b>AK-2515-06</b>
9,0 mm	<b>AK-2515-09</b>
13,0 mm	<b>AK-2515-13</b>
16,0 mm	<b>AK-2515-16</b>
19,0 mm	<b>AK-2515-19</b>
25,0 mm	<b>AK-2515-25</b>
32,0 mm	<b>AK-2515-32</b>

**SMITH-PETERSEN**  
 20,0 cm, 8"

Flachmeißel, Hohlmeißel, Osteotome, Hämmer  
 Chisels, Gouges, Osteotomes, Mallets  
 Cinceles, Gubias, Osteótomos, Martillos  
 Scalpelli, Sgorbie, Osteotomi, Martelli



9,0 mm	<b>AK-2516-09</b>
14,0 mm	<b>AK-2516-14</b>
16,0 mm	<b>AK-2516-16</b>
19,0 mm	<b>AK-2516-19</b>
25,0 mm	<b>AK-2516-25</b>

**SMITH-PETERSEN**  
20,0 cm, 8"



9,0 mm	<b>AK-2517-09</b>
14,0 mm	<b>AK-2517-14</b>
16,0 mm	<b>AK-2517-16</b>
19,0 mm	<b>AK-2517-19</b>
25,0 mm	<b>AK-2517-25</b>

**SMITH-PETERSEN**  
20,0 cm, 8"



6,0 mm	<b>AK-2518-06</b>
15,0 mm	<b>AK-2518-15</b>
20,0 mm	<b>AK-2518-20</b>
25,0 mm	<b>AK-2518-25</b>
30,0 mm	<b>AK-2518-30</b>
38,0 mm	<b>AK-2518-38</b>
44,0 mm	<b>AK-2518-44</b>
50,0 mm	<b>AK-2518-50</b>

**LAMBOTTE**  
24,0 cm, 9 1/2"



6,0 mm	<b>AK-2519-06</b>
15,0 mm	<b>AK-2519-15</b>
20,0 mm	<b>AK-2519-20</b>
25,0 mm	<b>AK-2519-25</b>
30,0 mm	<b>AK-2519-30</b>
38,0 mm	<b>AK-2519-38</b>
44,0 mm	<b>AK-2519-44</b>
50,0 mm	<b>AK-2519-50</b>

**LAMBOTTE**  
24,0 cm, 9 1/2"



**COLLIN**  
20,0 cm, 8"  
**AK-2520-20**



**PARTSCH**  
18,0 cm, 7"  
**AK-2521-18**

mit Bleifüllung  
 lead filled head  
 cabezal relleno de plomo  
 testa di piombo



**BERGMANN**  
24,0 cm, 9 1/2"  
**AK-2522-24**

**Sterilisation**  
**Sterilization**  
**Esterilización**  
**Sterilizzazione**



**Sterilisierzangen**  
**Sterilizing Forceps**  
**Pinzas para esterilización**  
**Pinze per sterilizzazione**



20,0 cm, 8"  
**AK-2522-20**



**CHEATTLE**  
27,0 cm, 10<sup>5</sup>/<sub>8</sub>"  
**AK-2523-27**



**ROGGE**  
23,0 cm, 9"  
**AK-2524-23**



**PYE-SMITH (HARRISON)**  
30,0 cm, 12"  
**AK-2525-30**



**MAYO**  
14,0 cm, 5<sup>1</sup>/<sub>2</sub>"  
**AK-2526-14**



**BUNT**  
12,0 cm, 4<sup>3</sup>/<sub>4</sub>"  
**AK-2527-12**



**STANDZYLINDER**

Ø 75 x 130 mm	<b>HW-2528-06</b>
Ø 75 x 175 mm	<b>HW-2528-07</b>
Ø 100 x 175 mm	<b>HW-2528-08</b>
Ø 100 x 200 mm	<b>HW-2528-09</b>



**RUNDE SCHALE**

Ø 40,0 mm	<b>HW-1130-04</b>
Ø 60,0 mm	<b>HW-1130-06</b>
Ø 80,0 mm	<b>HW-1130-08</b>
Ø 100,0 mm	<b>HW-1130-10</b>
Ø 120,0 mm	<b>HW-1130-12</b>
Ø 150,0 mm	<b>HW-1130-15</b>



**SPÜLSCHALE**

165 x 55 mm	0,75 l	<b>HWI-1133-00</b>
175 x 70 mm	1,00 l	<b>HWI-1133-10</b>
225 x 100 mm	2,00 l	<b>HWI-1133-20</b>
240 x 95 mm	2,75 l	<b>HWI-1133-30</b>
260 x 120 mm	4,00 l	<b>HWI-1133-40</b>
290 x 100 mm	5,00 l	<b>HWI-1133-50</b>
315 x 150 mm	5,50 l	<b>HWI-1133-60</b>
325 x 135 mm	8,00 l	<b>HWI-1133-70</b>
360 x 165 mm	12,00 l	<b>HWI-1133-80</b>
415 x 150 mm	14,00 l	<b>HWI-1133-90</b>



**NIERENSCHALE**

170 mm	<b>HW-1140-17</b>
250 mm	<b>HW-1140-25</b>
275 mm	<b>HW-1140-27</b>

Schalen  
Trays  
Bandejas  
Bacinelle



**INSTRUMENTENKÄSTCHEN**

200 x 150 x 25 mm	<b>HW-1200-01</b>
260 x 180 x 30 mm	<b>HW-1200-02</b>
300 x 220 x 30 mm	<b>HW-1200-03</b>
350 x 220 x 40 mm	<b>HW-1200-04</b>
220 x 170 x 50 mm	<b>HW-1200-05</b>
280 x 200 x 50 mm	<b>HW-1200-06</b>
320 x 240 x 50 mm	<b>HW-1200-07</b>
370 x 270 x 50 mm	<b>HW-1200-08</b>
420 x 320 x 50 mm	<b>HW-1200-09</b>



**NAEDELDOSE**

**HW-1300-00**

Ø 65 x 17 mm

Außen- und Innendose

Exterior and interior box

Caja exterior e interior

Scatola esterna es interiore

**HW-1300-01**

Ø 62 x 13 mm

Innendose allein

Interior box only

Caja interior, suelta

Scatola interiore sola



**SPÜLSCHALE  
MIT SKALIERUNG**

25 ccm

**HW-310-25**



**SPÜLBECHER  
MIT SKALIERUNG**

50 ccm

**HW-310-50**



Medi-Cab Instruments  
Small Industry Estate Sialkot Pakistan

---

**Phone:** +92-318-711579

**Emai:** [Medicabinstruments@gmail.com](mailto:Medicabinstruments@gmail.com)

**WebSite:** [www.medicabinstruments.com](http://www.medicabinstruments.com)